

**Seminar  
Proceedings**

**Coal Bed Methane  
in Alberta –  
What's it all about?**  
Information Series No. 108

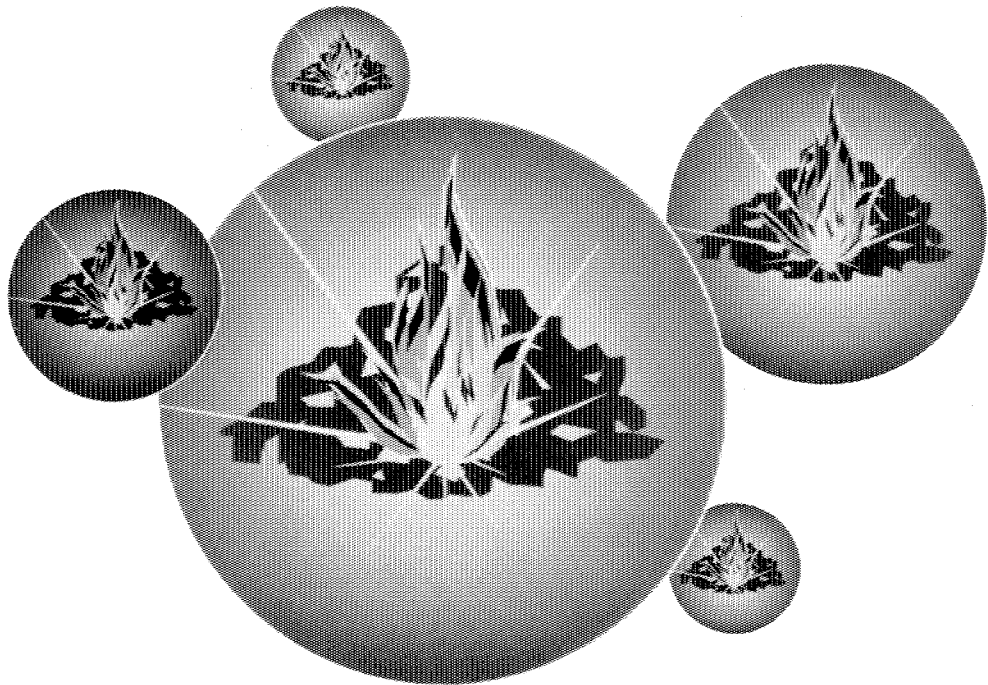

**ALBERTA  
RESEARCH  
COUNCIL**

Alberta  
Geological  
Survey

**Coal Bed Methane  
in Alberta –  
What's it all about?**

Information Series No. 108

Westward Inn, Calgary

**May 1 - 2, 1990**

Alberta Geological Survey

**Compiled by:**

Dennis Nikols

Shauna Treasure

Slavko Stuhec

Dianne Goulet

# SEMINAR SCHEDULE

---

May 1, 1990

---

8:00 - 8:30 Coffee

8:30 - 9:00 **Introduction** - ARC Staff and Dennis Nikols.

9:00 - 10:20 **Keith Murray** "*Technical Overview*".

10:20 - 10:40 Coffee Break

10:40 - 12:00 **Stan Graves** "*Development in the Warrior Basin of Alabama*".

12:00 - 1:00 **LUNCH**

1:00 - 2:20 **John Wallace** "*CBM Production and Operators Perspective*".

2:20 - 3:00 **Gordon Williams** "*Coal Areas in Canada*".

3:00 - 3:20 Coffee Break

3:20 - 4:00 **Gordon Williams** "*Coal Areas in Canada - cont'd*".

4:00 - 5:00 **Les Smith** "*Coal in Canada...*"  
"*Canada = San Juan - CBM Potential*"

---

May 2, 1990

---

8:00 - 8:30 Coffee

8:30 - 8:45 **INTRODUCTION** - Dennis Nikols

8:45 - 9:15 **Jim Lauder** - Alberta Department of Energy - Regulations.

9:15 - 10:20 **A.A Kahil** "*History and Experience of Canadian Companies in Coal Demethanation*".

10:20 - 10:40 Coffee Break

10:40 - 11:00 **A.A Kahil** "*History and experience ..cont'd*".

11:00 - 12:00 **Dennis Nikols** - Research and Information Requests, and Plans for Action.

12:00 - 1:30 **LUNCH**

1:30 - 3:00 **Panel Discussion**

3:00 - 3:20 Coffee Break

3:20 - 5:00 **Panel Discussion**



## D. KEITH MURRAY & ASSOCIATES, INC.

1658 Cole Boulevard  
Golden, CO 80401, U.S.A.

### COALBED METHANE: NATURAL GAS RESOURCES FROM COAL SEAMS

#### INTRODUCTION

Methane trapped, or occluded, in coal beds is a virtually untapped source of clean, sulfur-free, pipeline-quality energy that today constitutes an economically viable exploration and development objective. The production of gas from coal beds can be accomplished by drilling and completing either vertical or horizontal boreholes, utilizing essentially conventional technology, with some modifications, especially in the completion of such wells. In addition, many coalbed methane wells require initial dewatering of the coal by means of a variety of pumping arrangements. Most of the wells drilled for coal degasification require reservoir stimulation, usually through casing perforations, employing various combinations of hydraulic fracturing, such as sand-water, sand-foam, or sand-gel, in order to increase permeability to gas.

The production of gas from coal beds, unlike in-situ gasification techniques, is non-destructive to the coal, except possibly by the enlargement of already present cleats, or fractures, in the coal as a result of hydraulic fracturing. Furthermore, coalbed methane is high in heating value, generally between approximately 900 and 1,050 Btu/scf; conversely, gas produced from the in-situ combustion of coal is low in heat content, typically in the range of 150 to 300 Btu/scf.

The coalification process, by which organic matter (e.g. wood, peat) is converted to coal, generates very large quantities of methane, both biogenic (i.e., formed by bacterial action in the early stages of diagenesis) and thermogenic (formed by thermal reactions during the phase of catagenesis). This gas is stored in high concentrations in both the coal and the associated sediments after the gas-expulsion point in the coal has been attained. Volume-for-volume, high-rank coals are capable of storing several times as much gas as are porous sandstone reservoirs under similar conditions of pressure, due to the extremely high internal surface areas of coal--as high as 1.5 million ft<sup>2</sup>/lb (or about 3,300 ft<sup>2</sup>/g) (Cervik, 1969).

Until recently, methane from coal beds has been considered an "unconventional" resource because of the unique properties of coal, which constitutes both a source and a reservoir of natural gas. Coal is an extremely complex substance, one that still is incompletely understood. According to Van Krevelen (1961), coal has many attributes: it is a fuel, an organic sediment, a rock, a collection of plant debris, an organic chemical substance, a solid colloid, and a chemical reactant. It is not surprising, then, that such aspects as the reservoir behavior of coal are so

difficult to predict and to model, unlike the more conventional sandstone or carbonate rock reservoirs. In geologic basins such as the San Juan of Colorado and New Mexico and Black Warrior of Alabama, the experience of certain petroleum industry operators has progressed to the point where coalbed methane now may be considered a conventional resource, albeit one possessing a number of unsolved problems, particularly in the area of production.

An important characteristic of coalbed methane wells, in particular those that initially produce water along with the gas, is an increase in gas production with time and a corresponding decrease in water production. This gas production incline may persist for several years before the inevitable decline occurs. Based on limited, but well-documented, production histories, it appears that typical coalbed methane wells will be long-lived.

When optimum conditions of rank, gas saturation, reservoir temperature, coal permeability, and other critical factors are present, a high rate of success should be experienced in the development of a coalbed methane field or pool. The ubiquitous nature of methane in coal beds generally is independent of structural position in a basin--i.e., whether anticlinal or synclinal--except as structural deformation may affect the permeability of a coalbed reservoir.

The resource base of coalbed methane in the United States alone is indeed immense. Preliminary estimates, based on very incomplete data on only the 48 conterminous states, place this resource in the range of 400 to 800 or more trillion cubic feet (Tcf) in-place. Estimates for individual basins vary from a few Tcf to more than 80 Tcf.

#### COAL AS A SOURCE AND RESERVOIR OF NATURAL GAS

Coal beds are both the source and a reservoir of the gas that is formed as a by-product of coalification, which is defined as the process by which vegetal material progressively evolves from peat to lignite to subbituminous, bituminous, and anthracite coal. According to Van Krevelen (1961), coalification ". . . may be defined as the gradual increase in carbon content of fossil organic material in the course of a natural process" (p.45). The peat-forming process involves biochemical reactions (diagenesis); bituminous and higher rank coals pass through a geochemical (thermogenic or catagenic) stage. The thermal maturation, or metamorphism, of humic kerogenous (Type III) organic matter (largely oxygen-rich lignin and cellulose) results in a progressive devolatilization of the kerogen in the coal, together with an increase in carbon content, decrease in moisture content, increase in calorific value and in percent vitrinite reflectance, increase in the degree of molecular ordering, and a marked

increase in thermally generated methane. The important aspects of calculating the thermal maturity of organic material in sediments (N.V. Lopatin's "Time-Temperature Index" of maturity), of kerogen maturation relative to vitrinite reflectance (as portrayed in the Van Krevelen diagram) and other source rock modelling techniques are well described in papers by Waples (1981), Meissner (1984), Rightmire, Eddy and Kirr (1984), and Choate, McCord and Rightmire (1986), in addition to Van Krevelen (1961).

The coalification process, from peat through anthracite, generates very large volumes of methane, with lesser amounts of carbon dioxide and nitrogen. From wood to low-rank lignite, some 1,350 ft<sup>3</sup>/ton of biogenic methane is generated (from Mott's Model, in Francis, 1954). From high-volatile bituminous to anthracite rank, the volume of thermally generated methane may exceed 10,000 ft<sup>3</sup>/ton of coal (Meissner, 1984, p. 418).

Not all of the methane generated during the coalification process migrates, or is expelled, out of coal beds. Coal has the capacity to retain, store, or adsorb (absorb?) methane in varying amounts. Methane storage is achieved by two primary methods: (1) in the microporosity system, wherein the gas is adsorbed within or upon the molecular structure of the kerogen in the coal, as well as in the micropores; and (2) in the macroporosity system, by conventional volume storage within the cleats, or fractures, that almost always are present in the coal (Meissner, 1984). The retention of methane in coal also can be expressed as follows: (1) as sorbed molecules on the internal surfaces or within the molecular structure of the coal; (2) as gas trapped within the matrix (macro- or micro-) porosity, which typically occurs in the 5Å to 500Å-plus size range; (3) as free gas within the cleat and fracture systems; and (4) as gas dissolved in the free water that may exist in the cleats and fractures (Choate, McCord and Rightmire, 1986). The volumes of methane that can be stored by molecular absorption and in the microporosity system are determined by (1) coal rank, (2) temperature, and (3) reservoir pressure (Meissner, 1984).

It is important to note that lower rank coals--i.e., those below medium-volatile bituminous--are characterized by having storage capacity beyond that of generation. Furthermore, expulsion of methane takes place at the point at which generation exceeds storage capacity under conditions of constant temperature and pressure. It can be seen, then, that methane in coals presents problems and paradoxes that are not found in the more "conventional" reservoir rocks. For example, one cubic foot of sandstone having 15 percent porosity and 75 percent gas saturation, at a depth of 2,500 feet, can hold 8.4 scf of gas, whereas the same volume of medium-volatile bituminous coal at the same depth can store 22 scf of gas, or 2.6 times as much. This phenomenon in part is due to the unique molecular structure of

coal, wherein the micropore system behaves as a molecular sieve, or a clathrate cage (analogous to the structure of zeolite minerals), in which methane molecules are nested within benzene rings. Another problem involves the dynamic nature of an accumulation of coal-derived methane which results from the ability of coal to act both as a "gas-generating machine", which, together with contiguous sandstone reservoir beds, contain the critical indigenous elements of source, migration paths, and traps (Meissner, 1984), and as an absorbing "sponge". Under conditions of thermal heating, coals may continue to generate methane, expelling it into the surrounding sediments when the total storage capacity of the coal has been exceeded. On the other hand, in basins undergoing thermal cooling, the coals will tend to readsorb from the surrounding clastic reservoirs the gas that the coal beds originally generated as their storage capacity is increased during the cooling phase. The thermal heating/high-volume gas generation and cooling/gas readsorption process can result in overpressured and underpressured gas accumulations, respectively, which are common in many of the coal-bearing North American Rocky Mountain basins. From the above, it is obvious that estimating the potential recoverable reserves and resources of methane contained today in a particular coal deposit will be a difficult and elusive task.

#### COMPOSITION OF COALBED GAS

Gas produced directly from coal beds almost always is of pipeline quality, being composed of from approximately 90 to 95 percent methane, in most instances, with minor amounts of heavier hydrocarbons, CO<sub>2</sub>, N<sub>2</sub>, O<sub>2</sub>, H<sub>2</sub>, and He, and with heating values generally between 950 and 1,050 Btu/scf (pure methane has a heating value of 1,012 Btu/scf at 60° F and atmospheric pressure). Analyses of gases recovered from certain relatively deep (greater than 5,000 feet), high-rank coals have indicated the presence of ethane and heavier hydrocarbons in concentrations of from 10 to 15 percent. The presence of H<sub>2</sub>S and other sulfur compounds in coalbed gas is virtually unknown, even from high-sulfur coals.

The composition, volumes, and liberation rates of hydrocarbons generated by the coalification process appear basically to be a function of the relative abundance of the various macerals--vitrinite, alginite, exinite, etc.--that are found in coals (macerals are microscopic components of coal and consist of the remains of the original plant material) (Ulery, 1984).

Additionally, the level of thermal alteration has a decided effect upon the composition of the hydrocarbons generated by terrestrial (Type III) organic matter. There is good evidence that autochthonous generation by hydrocarbons may, in some situations, occur at lower levels of thermal maturity (i.e., at

vitroinite reflectance levels of less than 0.6%  $R_o$ ) than generally believed (Snowdon and Powell, 1982). Furthermore, ethane and propane have been observed in immature sedimentary environments resulting from diagenetic reactions that may parallel or immediately follow the formation of biogenic methane (Schoell, 1983). In some basins (e.g., San Juan of Colorado and New Mexico), significant quantities of high-gravity liquid hydrocarbons (condensate?) are produced in certain wells, indicating the capacity of some types of coals to generate "oil".

#### PRODUCTION OF COALBED METHANE

Methane has been produced from coal beds through boreholes since the turn of the century. These holes include water wells and degasification holes, ranging from vertical to horizontal, designed to drain as much methane as possible for safety reasons from virgin coal seams prior to mining (see Skow, Kim and Deul, 1980). A number of production case histories are described in Tilton (1976), TRW Energy Engineering Division (1981), Murray (1981), Rightmire, Eddy and Kirr (1984), Choate, McCord and Rightmire (1986), Trevits and Finfinger (1986), Tew and Mancini (1986), and Shirley (1986).

A paper essential to the understanding of the behavior of coal-gas reservoirs was prepared by Cervik (1969), who observed that gas occurs in coal beds in both an adsorbed and a free state. Adsorbed gas is stored in the matrix, or micropores, of the coal and desorbs and diffuses through the coal at a rate governed by the diffusion process described by Fick's law or by other diffusion models, the driving force being a concentration gradient. Once the gas has migrated into the larger pores and into the cleat and fracture system, it then will flow into the well bore (or mine) according to Darcy's law, being driven by pressure gradient. These two types of mass transport are interdependent. The majority of coalbed reservoirs are at essentially hydrostatic pressure; and they depend on a system of fractures and cleats for most of their permeability. The relative permeabilities to both gas and water are critical to the initial production of methane from coalbed reservoirs. In water-saturated coals, water must be removed (usually by pumping) in order to upset the equilibrium that exists between the methane adsorbed within the micropores and that existing in the fracture system. Once a pressure gradient has been established, methane will first diffuse into the fracture system and then from the fractures into the wellbore, where the pressure has been lowered to less than hydrostatic. Ultimately, the productivity of a coalbed gas well will be largely dependent upon the ability to lower reservoir pressure and water saturation (if present) in the coalbed reservoir. A multiwell pattern is necessary in order to create drainage boundaries or areas of interference. Kissell and Edwards (1975) have demonstrated that by lowering the water



saturation in the fractures and cleats in the coal, the effective permeability to gas is increased (i.e., more space is made available to the gas phase), resulting in an increasing rate of gas production and a corresponding decrease in rate of water production. Such "negative declines" have been observed in a number of coalbed methane wells in productive areas such as the San Juan and Black Warrior basins.

Drilling and production activities involving coalbed methane wells in the most active areas in the United States--the San Juan, Black Warrior, Piceance and Raton basins--are summarized in the issues of the Quarterly Review of Methane from Coal Seams Technology (Gas Research Institute, 1983 - ).

### RESOURCES OF COALBED METHANE

A wide range of estimates pertaining to total in-place coalbed methane resources in the conterminous United States have been published since 1978. These estimates vary from a minimum of 72 Tcf to a maximum of 860 Tcf, with estimates of recoverable resources ranging from 10 to 487 Tcf. All of these estimates must be considered as very preliminary because they are based on incomplete data regarding both the magnitude and character of U.S. coal resources below 3,000 feet in depth and on the in-situ gas content of most of the coal beds involved. If one uses the data presented in Averitt (1975), the following estimate could be made: Estimated remaining coal resources in the United States, as of January 1, 1974, including total identified and hypothetical resources remaining in the ground beneath 0 - 6,000 feet of overburden, are 3,968 billion short tons (or approximately 4 trillion tons). If only 50 percent of this resource has an in-situ methane content of 200 ft<sup>3</sup>/ton (6.25 cc/g), then the total in-situ coalbed methane resource of the United States, including Alaska, could be on the order of 400 Tcf. This probably is a conservative figure for several reasons: (1) The total remaining U.S. coal resource in the ground is believed to be considerably more than 4 trillion tons, based on recent resource evaluations and on the fact that thick coal beds are known to exist below the 6,000-foot depth cutoff used by Averitt (1975) (in fact, coals occur at depths greater than 10,000 to 15,000 feet in some basins in the Rocky Mountain region); and (2) the gas content of many deposits of coal in the subsurface (principally, below 500 to 1,000 feet) exceeds 200 ft<sup>3</sup>/ton (6.25 cc/g), as shown by Rightmire, Eddy and Kirr (1984) and Diamond, La Scala and Hyman (1986). Published maps (as in Averitt, 1975; and Rightmire, Eddy and Kirr, 1984) also do not accurately represent the rank of all the coal deposits known to exist in many of the western U.S. basins, especially of those coals occurring below mineable depths. For example, from sample data from wells drilled for oil and gas, it is known that the rank of coals may increase considerably with depth. The low-rank

bituminous coal known from analyses of outcrop or coal mine samples may be low-volatile bituminous, or even approaching anthracite, from the same stratigraphic interval at a depth of, say, 10,000 feet.

#### PROBLEMS OF ASSESSMENT OF COALBED METHANE RESOURCES

The following are examples of some of the problems that complicate the assessment of this very large resource:

1. How can the gas resource present in low-permeability ("tight") sandstone reservoirs be separated from that stored in or derived from coal beds, particularly where these two types of reservoirs are intimately interbedded (as in the case of the Mesaverde Group in the Rocky Mountain region)? Most of the gas generated by the coalification process today is not present in the coals themselves; much of this coal-derived gas now may be trapped in other reservoir beds that are in close proximity to the coals.
2. If situations exist where it can be demonstrated that coal beds continue to recharge contiguous producing clastic reservoirs as a pressure differential between the two is established, how should such possibilities be addressed in unproven areas (as described in Meissner, 1984; and Rightmire, Eddy and Kirr, 1984)? Wyman (1984) believes that at least 50 percent of the gas in certain coal beds in the Lower Cretaceous sequence in the "Deep Basin" of western Canada can be recovered from the adjacent sandstones and conglomerates by means of diffusion from the coal matrix and Darcy flow through open fractures.
3. How does one evaluate an area in which coal beds occur within the window of active gas generation? Welte and others (1984, p. 47) describe the Elmworth gas field, located in the "Deep Basin" of northwestern Alberta, as being in ". . . a dynamic situation where gas is continually being generated in the center part of the Deep Basin and lost toward the surface and the more porous edge. In the inner core of the gas-generating rock column diffusion processes seem to be the predominating mode of transportation." The dynamic nature of coalbed "gas machines" is an extremely complex, yet very important, phenomenon that demands considerably more research.

#### RATIONALE FOR COALBED METHANE EXPLORATION

Exploration for coalbed methane should include aspects of both coal geology and petroleum geology, as well as a nonconventional approach to reservoir engineering. Predrilling activity should evaluate the geology of the entire coal-bearing sequence,

including any interbedded low-permeability ("tight") gas-bearing sandstones.

Studies should address the physical and chemical nature of the coal (rank, chemistry, depositional environment, etc.), the thermal history and hydrodynamics of the region of interest, thickness of the coal beds and of the overburden, geologic structure and tectonic features such as fracture patterns and igneous activity, coalbed gas desorption data in the study area, and a petrographic analysis of available coal cores and well cuttings.

### CONCLUSIONS

Coal constitutes one of the richest known sources of hydrocarbons. The coalification process generates very large volumes of methane--more than 8,000 ft<sup>3</sup>/ton of high-rank coal--that is biogenic and thermogenic in origin. Coal is an extremely complex organic substance and possesses the unique capability of being both a source and a reservoir of natural gas. Consequently, the reservoir behavior of coal, its production characteristics, and other aspects so important to the natural gas industry are difficult to predict and to model. In this sense, coalbed reservoirs can be considered "unconventional". However, the growing successful experience of operators in basins such as the San Juan in Colorado and New Mexico and the Black Warrior in Alabama has advanced to the point where coalbed methane now may be treated as a conventional resource. Gas from coals is an attractive exploratory objective for reasons that include the relatively shallow depths of most deposits of coal, the ubiquitous occurrence of gas in coal, and the very large gas generation and storage capacities of the higher rank coals. Furthermore, coal gas wells typically experience an increase in gas production with time, and a corresponding decrease in water production, if any. The production incline of some coalbed methane wells is expected to persist for a number of years, based on the few well-documented production histories that are available.

Methane trapped in coals beds is a virtually untapped source of clean, pipeline-quality energy that today is an attractive, economically viable objective for the gas producing industry. Based on very preliminary studies, trillions of cubic feet of recoverable methane are believed to exist in many of the coal-bearing areas in the United States, as wells as in both western and eastern Canada.

In an adjudication dated March 1980, Judge Glenn R. Toothman, of Greene County, Pennsylvania, stated that ". . . (coalbed gas) is similar to other natural gases found below the earth's surface in composition and content, but which, in the manner of its origin

has, different from the other gases, a close affinity for and association with coal seams. In its original state it permeates and penetrates the coal bed, is its alter ego, its constant companion, its geological handmaiden, and is sometimes viewed as its contumacious free-spirited bride, but more generally regarded as its ill-chosen bridesmaid. It is found with the coal when they come to mine it, stays with coal as it leaves, and remains in the space after the mining has been done. Its past has been filled with peril and tragedy, its present is seen as having a modest commercial attractiveness, and its future as a fuel potential has become increasingly brighter."

D. Keith Murray  
November, 1989

## SELECTED REFERENCES FOR COALBED METHANE

- Averitt, Paul, 1975, Coal resources of the United States, January 1, 1974: U.S. Geol. Survey Bull. 1412, 131 p.
- Baker, E. C., Grau, R. H., III, and Finfinger, G. L., 1986, Economic evaluation of horizontal borehole drilling for methane drainage from coalbeds: U.S. Bureau of Mines Information Circular 9080, 18 p.
- Cervik, J., 1969, Behavior of coal-gas reservoirs: U.S. Bureau of Mines Technical Progress Report 10, 10 p.
- Choate, Raoul, McCord, J. P., and Rightmire, C. T., 1986, Assessment of natural gas from coalbeds by geologic characterization and production evaluation: in Oil and Gas Assessment, D.D. Rice, ed.: AAPG Studies in Geology No. 21, p. 223-245.
- Colorado School of Mines Research Institute, 1982, Geologic investigation of the methane potential of western U.S. coalbeds - final report (December 1980-June 1982), (prepared by R. D. Merry and V. E. Larsen): Gas Research Institute, Chicago, IL, 79 p. + appendix.
- Curl, S. J., 1978, Methane prediction in coal mines: IEA Coal Research Report No. ICTIS/TR 04, London, December, 77 p.
- Deul, Maurice, 1964, Methane drainage from coalbeds: a program of applied research: *in* Proceedings, Rocky Mountain Coal Mining Institute, 60th Regular Meeting, June 28, 30, July 1, p. 54-60.
- Diamond, W. P., La Scola, J. C. and Hyman, D. M., 1986, Results of direct-method determination of the gas content of U.S. coalbeds: U.S. Bureau of Mines Information Circular 9067, 95 p.
- Francis, Wilfred, 1954, Coal, its formation and composition: London, Edward Arnold Publications, Ltd. (esp. p. 317, Mott's Classification; and p. 359-363, incl. Table VIII.II, Mott's Table).
- Gas Research Institute, 1982, Coalbed methane recovery technology R & D plan: Gas Research Institute, Chicago, IL, May, 18 p.
- Gas Research Institute, 1983-, Quarterly Review of Methane from Coal Seams Technology: Published by GRI, Chicago, Illinois and printed by the Colorado School of Mines, Golden, CO (C. F. Brandenburg, Managing Editor; S. D. Schwochow, Production Manager).
- Gas Research Institute, 1985, Coalbed methane--coming of age as an energy resource: *in* Grid, January/February, published by Gas Research Institute, Chicago, IL, p. 5-13.
- Giron, A., Pavone, A. M., and Schwerer, 1984, Mathematical models for production of methane and water from coal seams: Quarterly Review of Methane from Coal Seams Technology, Gas Research Institute, vol. 1, no. 4, March, p. 19-34.
- Heroux, Yvon, Chagnon, Andre, and Bertrand, Rudolf, 1979, Compilation and correlation of major thermal maturation indicators: AAPG Bull., vol. 63, no. 12, p. 2128-2144.
- Hood, A., Gutjahr, C. C. M., and Heacock, R. L., 1975, Organic metamorphism and the generation of petroleum: AAPG Bull., vol. 59, no. 6, p. 986-996.
- Kent, H. C., and Herrington, J. C., 1986, Estimation of potential gas resources--methodology of the Potential Gas Committee: *in* Oil and Gas Assessment--Methods and Applications, D. D. Rice, ed.: AAPG Studies in Geology No. 21, p. 143-149.
- Kim, A. G., 1976, Estimating methane content of bituminous coalbeds from adsorption data: U.S. Bureau of Mines RI 8245, 22 p.

- Kissell, F. N., and Edwards, J. C., 1975, Two-phase flow in coalbeds: U.S. Bureau of Mines RI 8066, 16 p.
- Lambert, S. W., Trevits, M. A., and Steidl, P. F., 1980, Vertical borehole design and completion practices to remove methane gas from mineable coalbeds: U.S. Dept. of Energy, DOE/CMTC/TR-80/2, Carbondale, IL, August, 163 p.
- Law, B. E., 1981, Relationships of source-rock, thermal maturity and overpressuring to gas generation and occurrence in low-permeability Upper Cretaceous and Lower Tertiary rocks, greater Green River basin, Wyoming, Colorado, and Utah: *in* Hydrocarbon Source Rocks of the Greater Rocky Mountain Region, J. Woodward, F. F. Meissner, and J. L. Clayton, eds.: Rocky Mountain Assoc. Geologists, Denver, p. 469-490.
- Lewin and Associates, Inc., 1987 (a), A geologic assessment of natural gas from coal seams in the Warrior Basin, Alabama (draft report submitted to Gas Research Institute, Chicago, IL, January).
- Lewin and Associates, Inc., 1987 (b), A geologic assessment of natural gas from coal seams in the Piceance Basin, Colorado (draft report submitted to Gas Research Institute, Chicago, IL, January).
- Masters, J. A., 1984, Lower Cretaceous oil and gas in western Canada, *in* Elmworth--Case Study of a Deep Basin Gas Field, J. A. Masters, ed.: AAPG Memoir 38, p. 1-33.
- Meissner, F. F., 1984, Cretaceous and lower Tertiary coals as sources for gas accumulations in the Rocky Mountain area, *in* Hydrocarbon Source Rocks of the Greater Rocky Mountain Region, J. Woodward, F. F. Meissner, and J. L. Clayton, eds.: Rocky Mountain Assoc. Geologists, Denver, CO, p. 401-431.
- Murray, D. K., 1981, Methane from coal, *in* Coal and Energy Quarterly, S. Parkinson, ed.: National Coal Board, no. 29, Summer 1981, London, p. 30-38.
- Murray, D. K., Fender, H. B., and Jones, D. C., 1977, Coal and methane gas in the southeastern part of the Piceance Creek basin [Colorado], *in* Exploration Frontiers of the Central and Southern Rockies, H. K. Veal, ed.: Rocky Mountain Assoc. Geologists, Denver, CO, p. 379-405.
- Palacas, J. P., 1986, Thermal maturity mapping of the United States (abs.), *in* USGS Research on Energy Resources--1986, Program and Abstracts, V. E. McKelvey Forum on Mineral and Energy Resources: U.S. Geol. Survey Circ. 974, p. 53.
- Potential Gas Committee, 1981, Potential gas resources from nonconventional sources--gaseous coal seams, *in* Potential Supply of Natural Gas in the United States (as of December 31, 1980) : Potential Gas Agency, Colorado School of Mines, Golden, CO, May, p. 59-65.
- Resource Enterprises, Inc., 1986, Development and evaluation of technology for methane production from a deep coal seam in the Piceance Basin [Colorado]--annual report, June 1984-May 1985 (prepared by J. C. Seccombe, J. J. Schwoebel, T. L. Logan, A. D. Decker and J. D. Cooper): Gas Research Institute, Chicago, IL, March, 102 p. + 2 appendices.
- Rightmire, C. T., Eddy, G. E., and Kirr, J. N. (eds.), 1984, Coalbed methane resources of the United States: AAPG Studies in Geology Series #17, 378 p.
- Schoell, M., 1983, Genetic characterization of natural gases: AAPG Bull., vol. 67, no. 12, p. 2225-2238.
- Shirley, Kathy, 1986, Coalbed methane coming of age: *in* AAPG Explorer, AAPG, Tulsa, OK, December, p. 1, 8, and 9.
- Skow, M. L., Kim, A. G., and Deul, M., 1980, Creating a safer environment in U.S. coal mines--the Bureau of Mines Methane Control Program, 1964-79: U.S. Bureau of Mines Impact Report, Washington, DC, 50 p.

- Snowden, L. R., and Powell, T. G., 1982, Immature oil and condensate— modification of hydrocarbon generation model for terrestrial organic matter: AAPG Bull., v. 66, no. 6, p. 775-788.
- Tew, B. H., and Mancini, E. A., 1986, Energy resources of northwestern Alabama--guidebook for the 1986 Annual Meeting of the American Association of Petroleum Geologists, Energy Minerals Division, Atlanta, GA (EMD Field Trip 1, June 18-20, 1986): Geological Survey of Alabama, Tuscaloosa, 44 p.
- Tilton, J. G., 1976, Gas from coal deposits: *in* Natural Gas from Unconventional Geologic Sources: Natl. Acad. Sci., p. 206-229.
- Tissot, B. P., 1984, Recent advances in petroleum geochemistry applied to hydrocarbon exploration: AAPG Bull., vol. 68, no. 5, p. 545-563.
- Tissot, B. P., and Welte, D. H., 1978, Petroleum formation and occurrence--a new approach to oil and gas exploration: New York, NY, Springer-Verlag, 538 p.
- Trevits, M. A., and Finfinger, G. L., 1986, Results given of studies concerning methane extraction from coalbeds: Mining Engineering, August, p. 805-808.
- TRW Energy Systems Group, 1981, Economic analysis of vertical wells for coalbed methane recovery: U.S. Dept. of Energy, DOE/MC/08089-107, Morgantown, WV, April, 56 p.
- TRW Energy Engineering Division, 1981, Coalbed methane production case histories: U.S. Dept. of Energy, DOE/METC/08089-115, Morgantown, WV, var. pag.
- Ulery, J. P., 1984, Effects of petrographic characteristics on coalbed gas content, *in* Bureau of Mines Research 1984, J. R. Pederson, ed.: U.S. Bureau of Mines, p. 15-16.
- Van Krevelen, D. W., 1961, Coal--typology, chemistry, physics, constitution: Amsterdam, Elsevier Publishing Co., 514 p.
- Waples, D. W., 1980, Time and temperature in petroleum formation: application of Lopatin's method to petroleum exploration: AAPG Bull., vol. 64, no. 6, p. 916-926.
- Waples, Douglas, 1981, Organic geochemistry for exploration geologists: CEPCO Div., Burgess Publishing Co., Minneapolis, MN, 151 p.
- Welte, D. H., Schaefer, R. G., Stoessinger, W., and Radke, M., 1984, Gas generation and migration in the Deep Basin of western Canada, *in* Elmworth--Case Study of a Deep Basin Gas Field, J. A. Masters, ed.: AAPG Memoir 38, p. 35-47.
- Wyman, R. E., 1984, Gas resources in Elmworth coal seams, *in* Elmworth--Case Study of a Deep Basin Gas Field, J. A. Masters, ed.: AAPG Memoir 38, p. 173-187.

- D. KEITH MURRAY

# COALBED METHANE SEMINAR

5 December 1989

- I. What is coal?
  - A. Definition
  - B. Origin of coal
  - C. Gas generation in coal
  - D. Classification and properties of coal
- II. Definition of the coalbed reservoir
  - A. Identification of coal in the subsurface
- III. Hydrologic indicators of gas producibility
  - A. Pressure regime
  - B. Hydraulic head
  - C. Hydrochemistry
- IV. Geologic controls on methane recovery
  - A. Permeability enhancement
- V. Coalbed reservoir engineering
  - A. Unique aspects of coal reservoirs
  - B. Reserve estimation
- VI. Drilling, completing, and producing coalbed methane wells
- VII. Determining the gas resource
- VIII. Size and quantity of the coalbed methane resource in the U.S.
  - A. Distribution by basin
  - B. Storage capacity, coals vs. sandstones
  - C. Gas-in-place sample calculations
- IX. Case studies of coalbed methane production and economics
  - A. Summary of resource economics methodology
  - B. Overview of economic analysis
  - C. Economics of new developments in western U.S. coal basin
  - D. Economics of field optimization in an eastern U.S. coal basin
  - E. Economics of multiple zone completions in an Appalachian coal basin
- X. Present development in the United States
  - A. Established industry
    1. Warrior (or Black Warrior) basin, AL
    2. San Juan basin NM & CO
  - B. Developing industry
    1. Piceance basin, CO
    2. Raton basin, CO & NM
    3. Central Appalachian basin, WV & VA
    4. Northern Appalachian basin, PA & WV
    5. Wyoming basins
    6. Western Washington basins



Figure 1

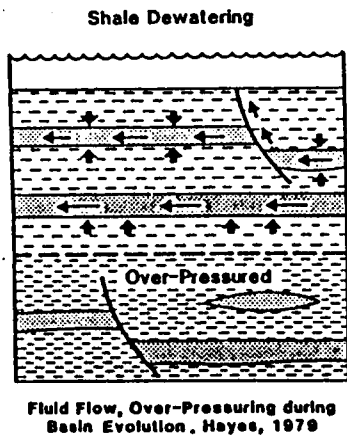

Figure 2

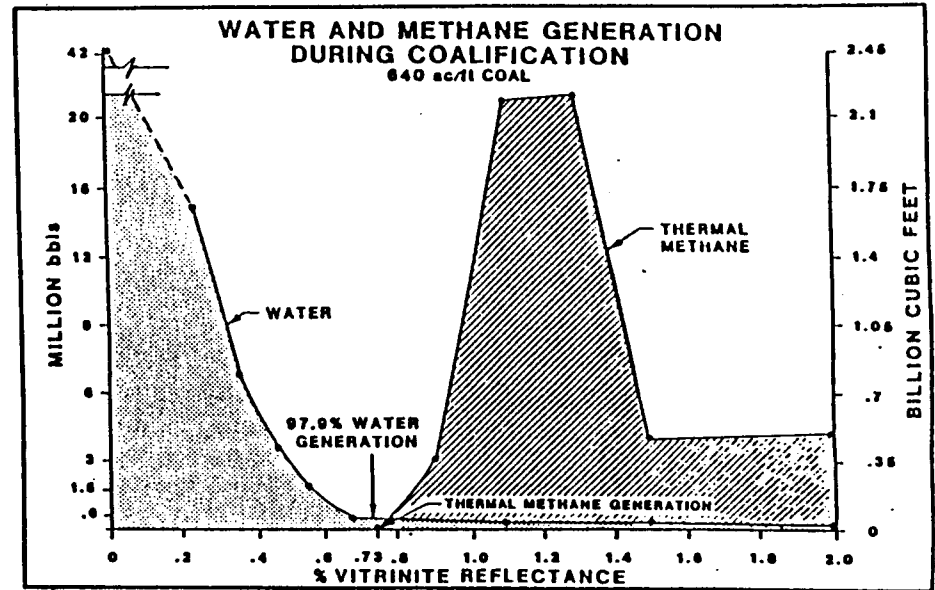

Figure 3

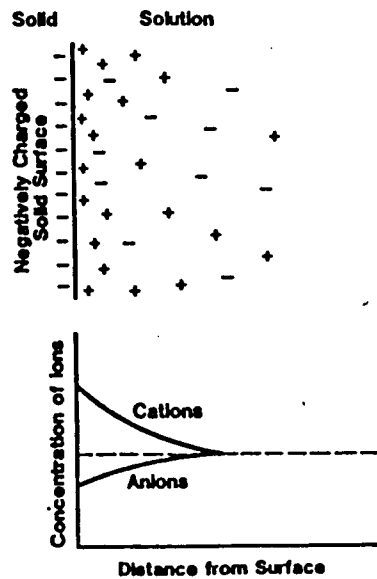
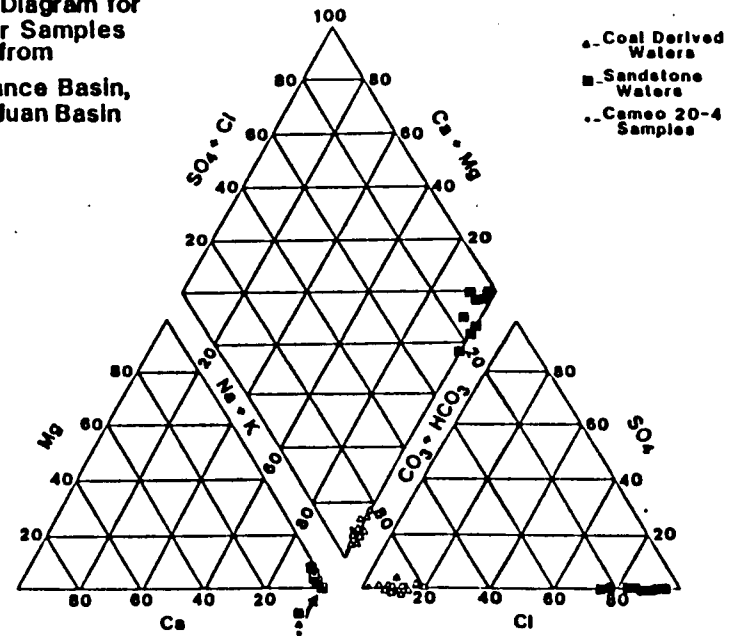

Figure 4

Piper Diagram for Water Samples from Piceance Basin, San Juan Basin



(Dacker, Klusman & Harner, 1987)

**COAL - "A BLACK COMBUSTIBLE, MINERAL SOLID RESULTING FROM THE PARTIAL DECOMPOSITION OF VEGETABLE MATTER AWAY FROM AIR AND UNDER VARYING DEGREES OF INCREASED TEMPERATURE AND PRESSURE OVER A PERIOD OF MILLIONS OF YEARS; USED AS A FUEL AND IN THE PRODUCTION OF COKE, COAL GAS, WATER GAS, MANY COAL-TAR COMPOUNDS" (WEBSTER'S NEW WORLD DICTIONARY, 1982)**

**COAL - "A CHEMICALLY AND PHYSICALLY HETEROGENEOUS MINERAL OR ROCK CONSISTING PRINCIPALLY OF CARBON, HYDROGEN, AND OXYGEN, WITH LESSER AMOUNTS OF SULFUR AND NITROGEN. OTHER CONSTITUENTS ARE THE ASH-FORMING INORGANIC COMPOUNDS DISTRIBUTED AS DISCRETE PARTICLES OF MINERAL MATTER THROUGHOUT THE COAL SUBSTANCE" (CHEMISTRY OF COAL UTILIZATION, 1981)**

**COAL - "COAL IS A COMBUSTIBLE ROCK WHICH HAD ITS ORIGIN IN THE ACCUMULATION AND PARTIAL DECOMPOSITION OF VEGETATION" (GEOLOGY OF COAL, 1940)**

# COALIFICATION

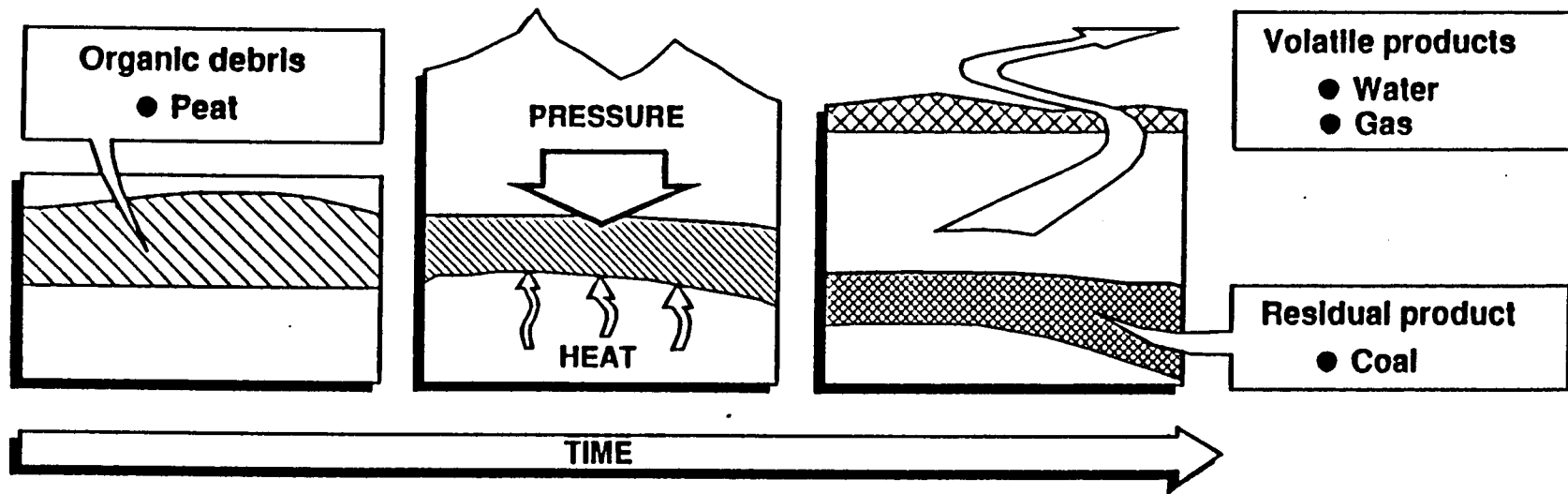

# COAL CYCLE

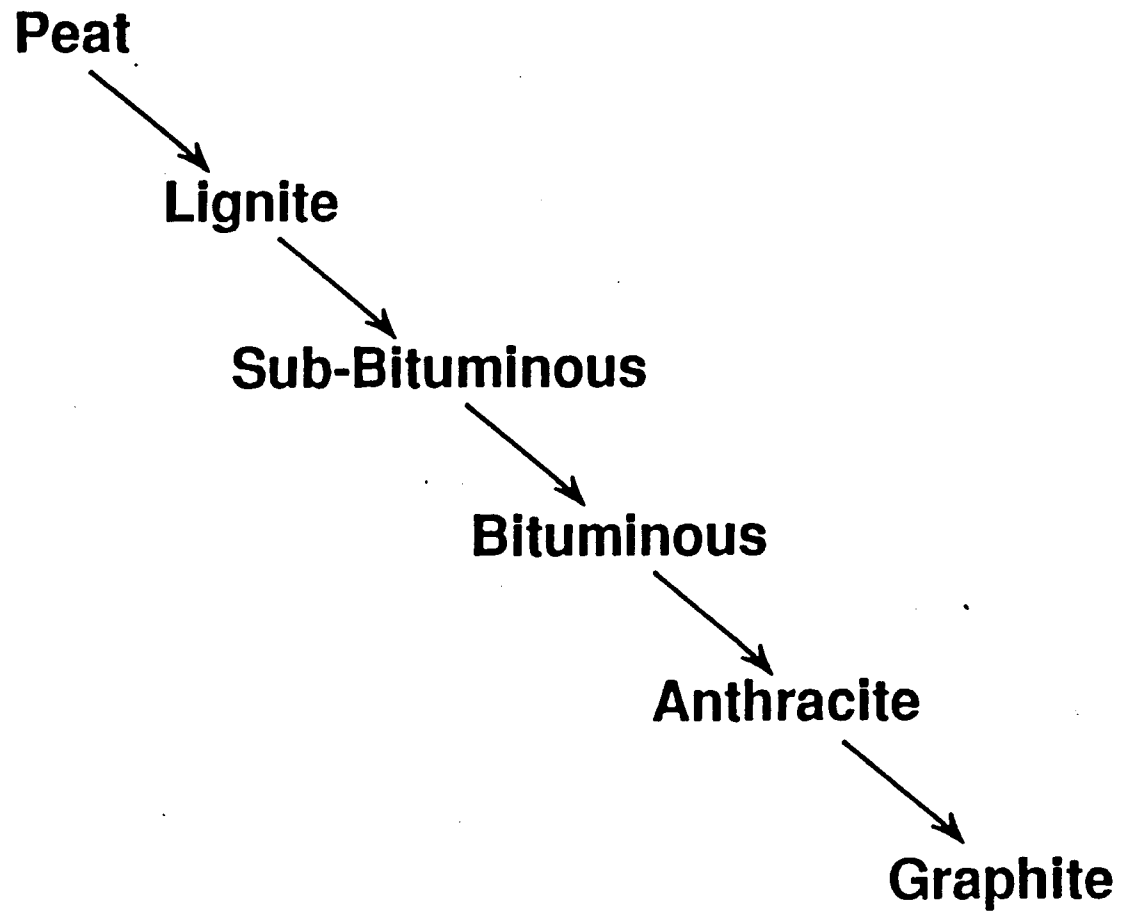

# GAS GENERATION IN COAL

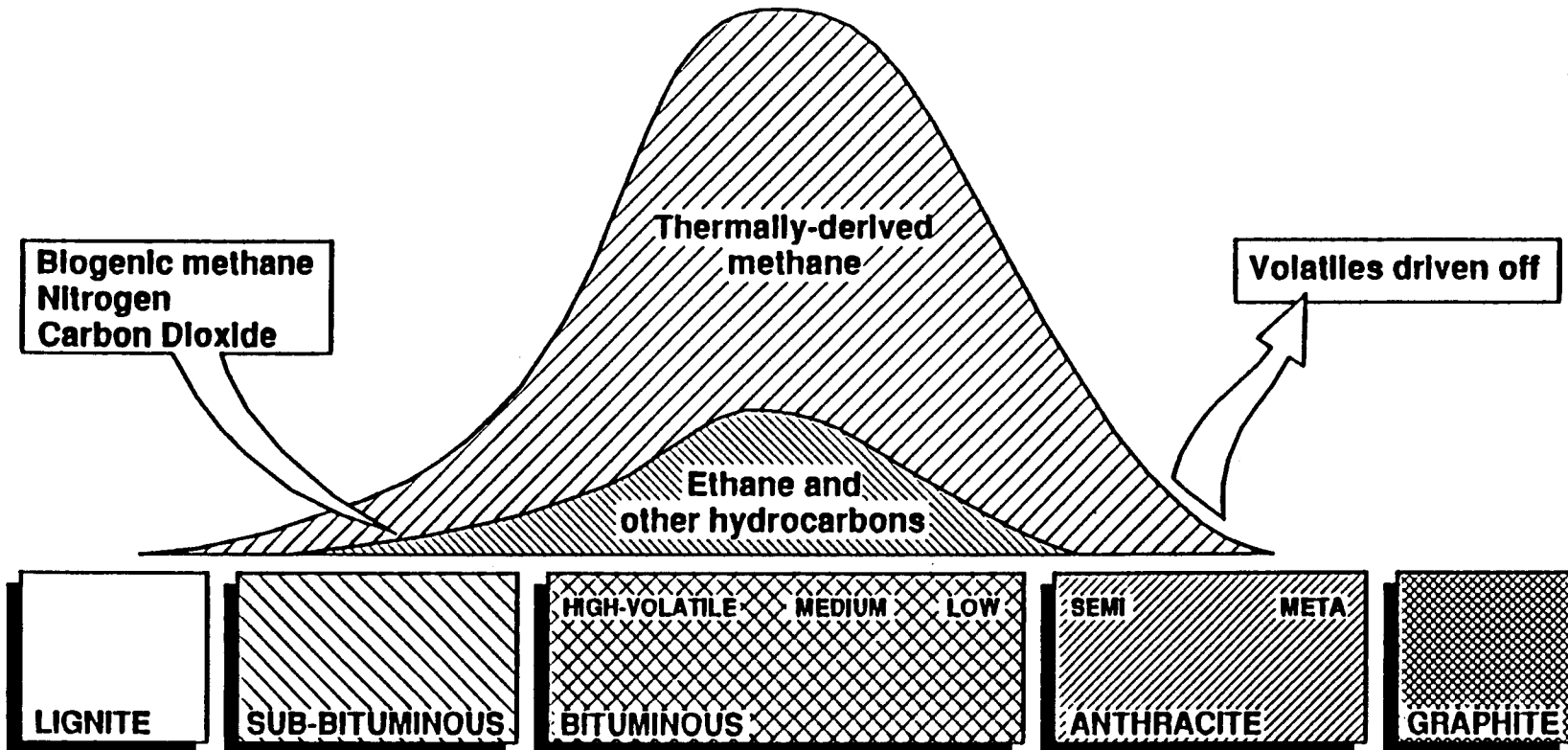

# GEOHERMAL DIAGENETIC CRITERIA

(GEOCHEM LABORATORIES, INC.)

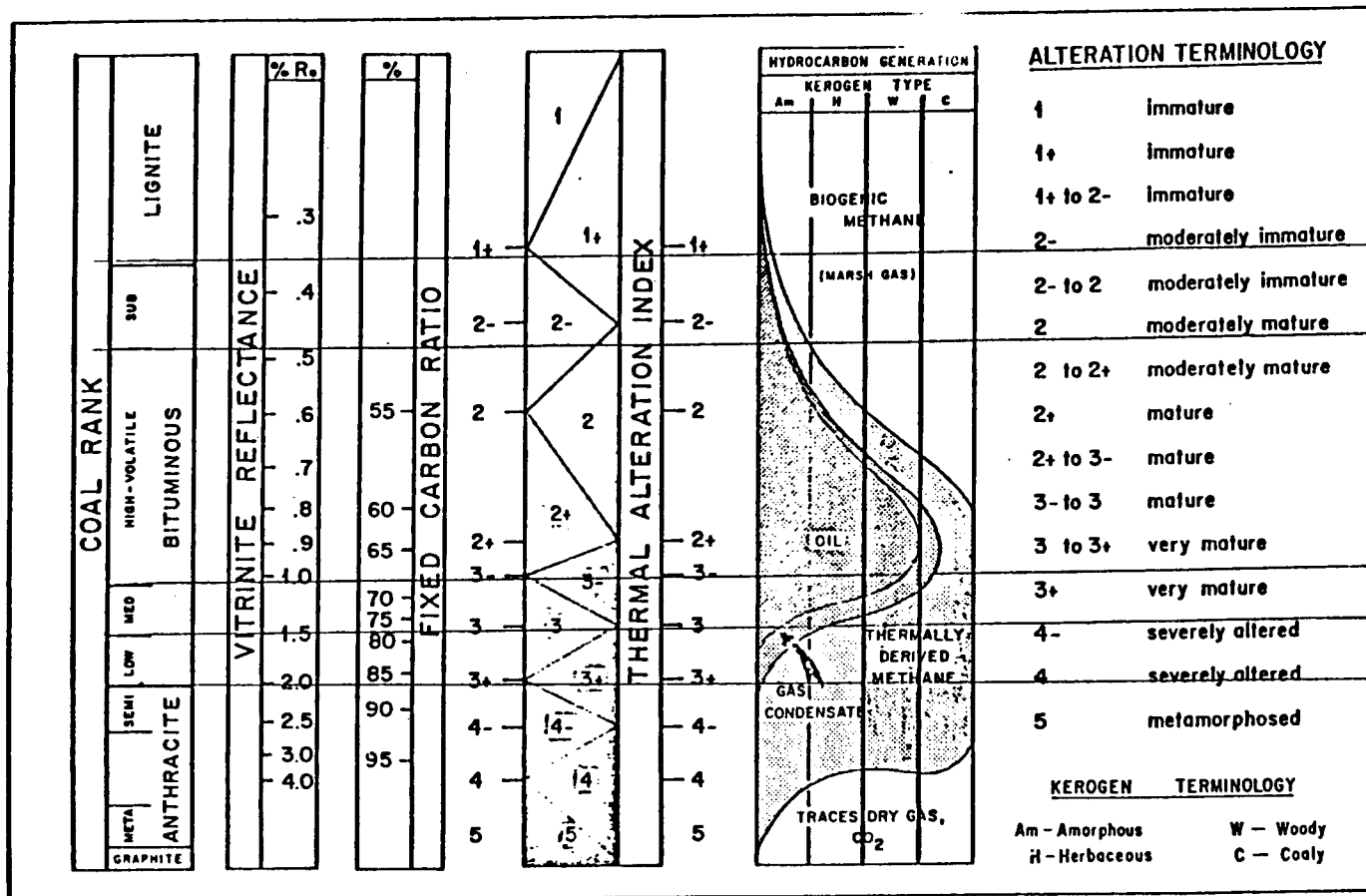
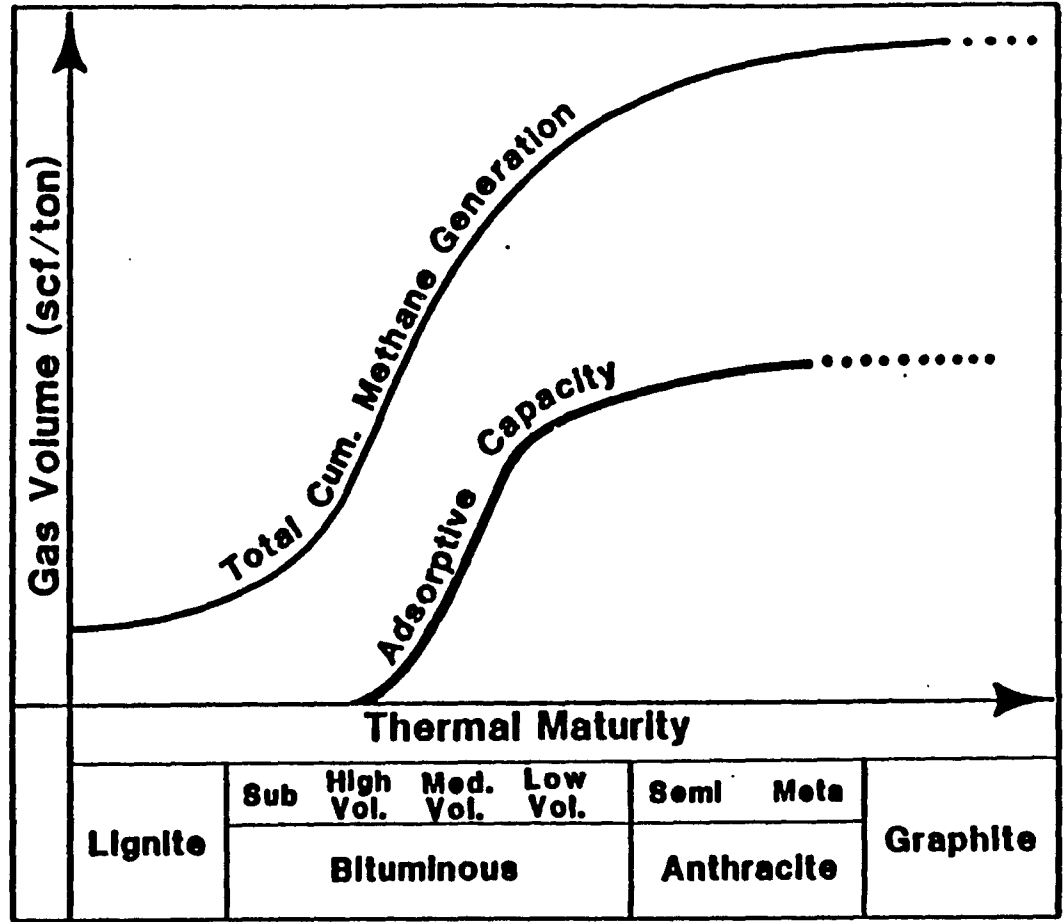

Figure 2

Volatiles Matter VM (daf) (%)	Vitrinite Reflectance $R_o$ (%)	ASTM Coal Rank	Thermally Generated CH <sub>4</sub> (cc/g)
65±	0.23	Peat	
		Lignite	
53±	0.36	Sub- Bituminous	
50±	0.43		
46.9±	0.47		
45.6±	0.49		
42±	0.51		
38.7	0.69	High Volatile Bituminous	0
.....(37.8).....	.....(0.73).....		
31	1.11	Medium Volatile Bituminous	28.04
22	1.60	Low Volatile Bituminous	76.54
14	2.04	Semi- Anthracite	140.45
8	2.40	Anthracite	219.59
2	5.0	Meta-Anthracite	415.62

Figure 4. Summary of thermally generated methane as related to coal rank, volatile matter content on a dry ash-free (daf) basis, and vitrinite reflectance ( $R_o$ ). ASTM is American Society for Testing and Materials. (Choate, et al., 1986)

# GAS GENERATION AND ADSORPTIVE CAPACITY



- \* Coals Generate More Gas than Can be Adsorbed
- \* Gas and Water Expelled into Surrounding Strata

After: Kim, ~~Melner~~, Decker, Rice  
*Melner*

Resource Enterprises, Inc.



## APPROXIMATE VALUES OF SOME COAL PROPERTIES IN DIFFERENT RANK RANGES

	Lignite	Subbit.	High Vol. Bit.			Bituminous		Anthracite	
			C	B	A	Medium Vol.	Low Vol.		
% C (min. matter free)	65-72	72-76	76-78	78-80	80-87	89	90	93	
% H	4.5	5	5.5	5.5	5.5	4.5	3.5	2.5	
% O	30	18	13	10	10-4	3-4	3	2	
% O as COOH	13-10	5-2	0	0	0	0	0	0	
% O as OH	15-10	12-10	9	7	7-3	1-2	0-1	0	
Aromatic C atoms % of									
Total C	50	65	7	7	75	80-85	85-90	90-95	
Av. no. benz. rings/layer	1-2	?	←————— 2-3 —————→				5?	>25?	
Volatile matter, %	40-50	35-50	35-45	?	31-40	31-20	20-10	<10	
Reflectance, %, Vitrinite	0.2-0.3	0.3-0.4	0.5	0.6	0.6-1.0	1.4	1.8	4	
Density	—————→ increases					—————→			
Total Surface Area	←————— minimum					—————→			
Plasticity and Coke Formation			————— only —————						
Calorific value, moist, min. matter free, BTU/lb.	7,000	10,000	12,000	13,500	14,500	15,000	15,800	15,200	

# Composite Coal Presentation

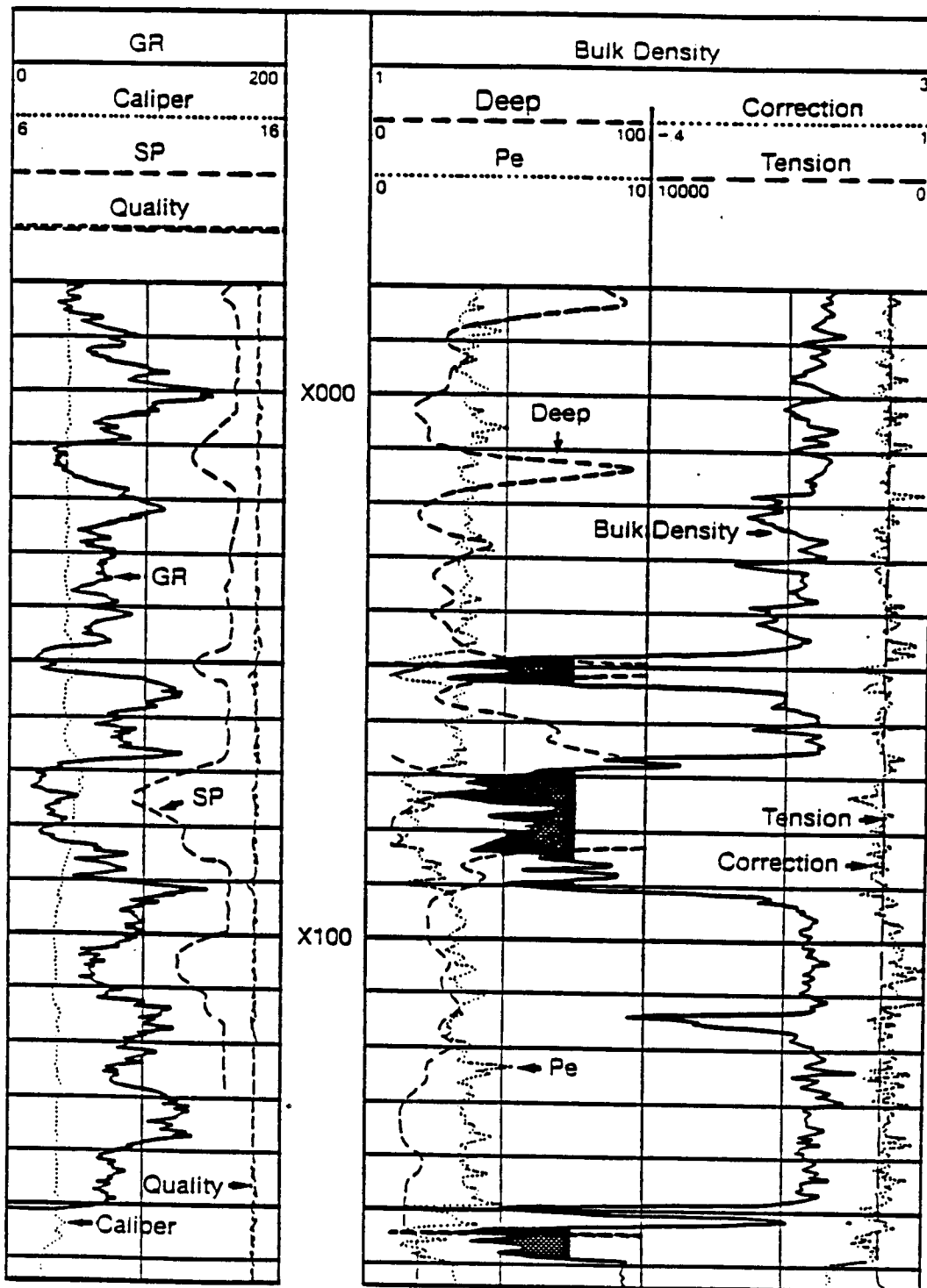

FIGURE 19 CUSTOMIZED LOG PRESENTATION USED IN COALBED WELLS

(Halliburton, 1987)

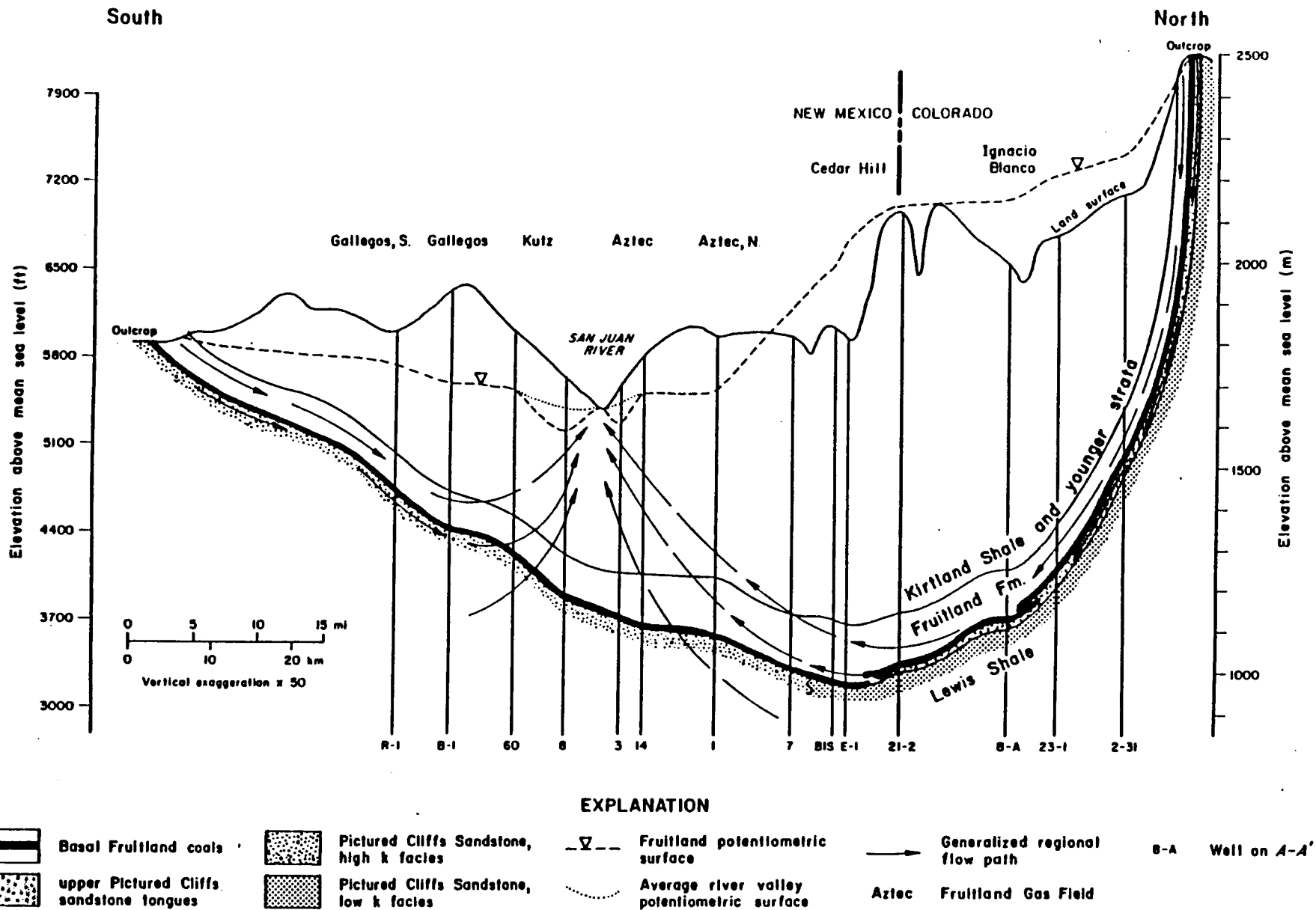
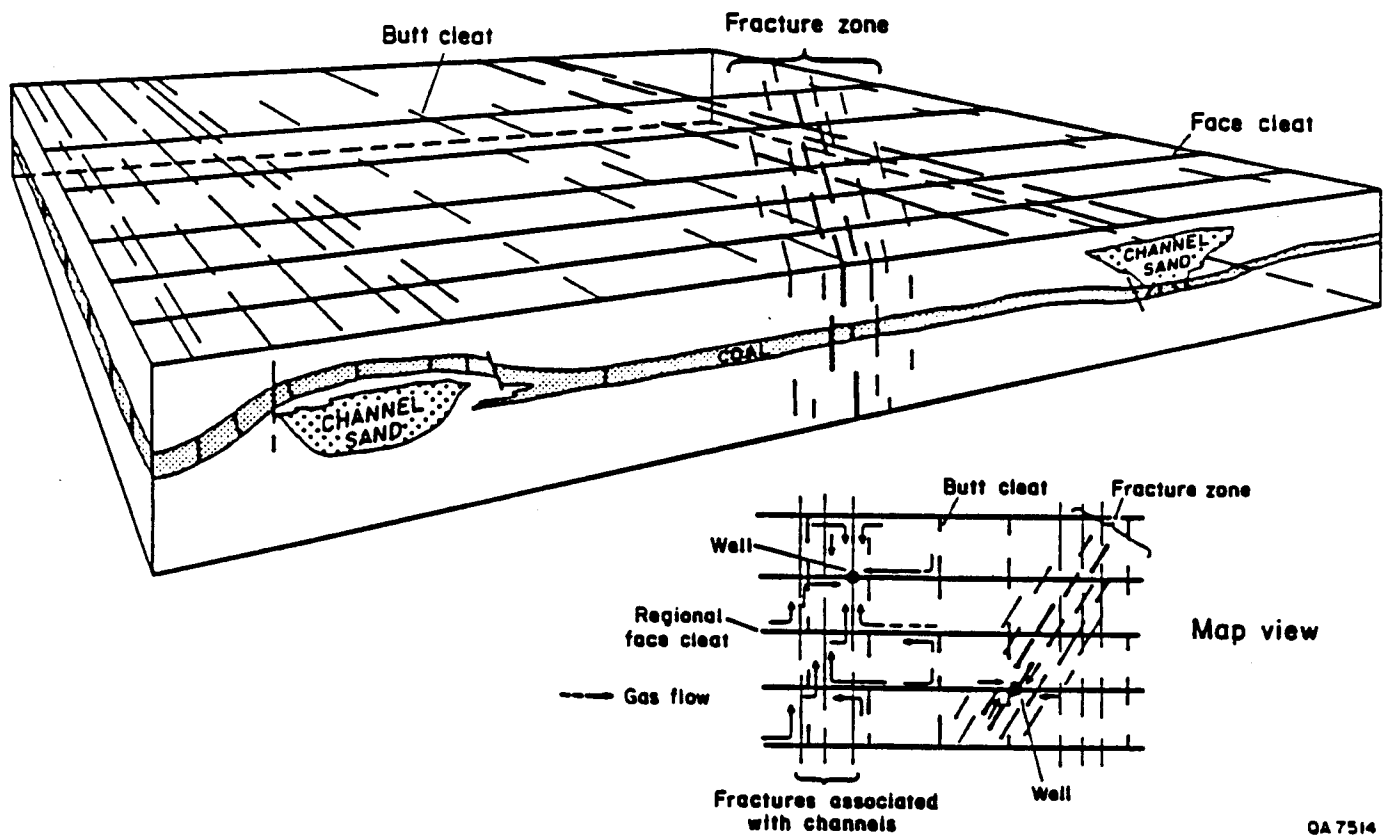
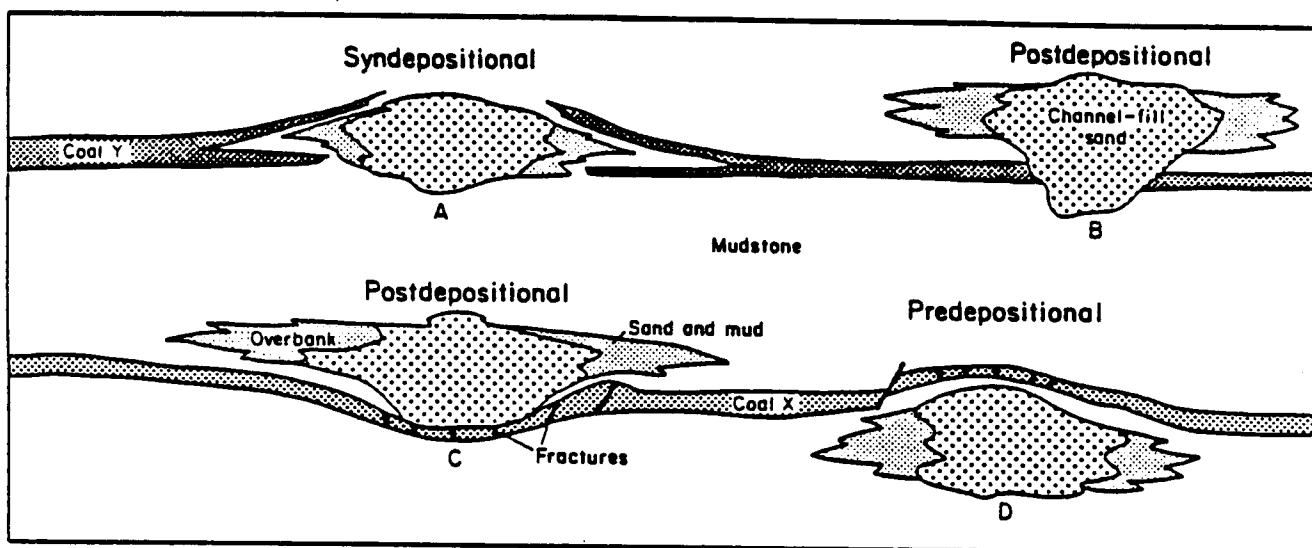

Figure 2. Schematic ground-water flow, Fruitland-Pictured Cliffs aquifer system (from Kaiser and Swartz, 1988). See figure 4 for line of section and location of wells. Basal Fruitland coal seams pinch out in vicinity of Cedar Hill field between wells 21-2 and E-1. Northern outcrop is approximately 2300 ft (700 m) higher than southern outcrop. In the north, the potentiometric surface is above land surface and independent of it, indicating artesian conditions.



QA 7514

Figure 15. Fracture permeability in coal. Tectonic fractures that intersect the face cleat at high angle are suggested exploration targets. Fracture-enhanced permeability may also occur adjacent to sandstones because of differential compaction.



QA 7513

Figure 8. Relationship between channel-fill sandstones and coal seams. Coal 'Y' splits and pinches out at interface with channel-fill sandstone, A; coal seam 'Y' was eroded by channel B. Coal seam 'X' is folded and fractured under postdepositional channel-fill sandstone, C, and over predepositional channel-fill sandstone, D (concepts from Donaldson, 1979).

## **SUMMARY OF PRESENT STATUS**

- Long, high-conductivity fractures are required for low-permeability ( $k < 10$  md) coals to recover a large fraction of the gas in place
- Field experience in fracturing indicate that high-gradient treatment pressures predominate. The reasons for the high pressures are not clearly understood
- Laboratory experiments have demonstrated the high-pressure treatments result from
  - A. Low strength and friability of the coal, and
  - B. In-situ stresses that are high in comparison with the coal strength

# **SUMMARY OF PRESENT STATUS**

(Continued)

- Fracture designs need to be planned to determine potential for high treatment pressures during pumping of the pad. Proppant schedule is to be selected based on the treatment-pressure response during pad pumping
- Out-of-zone fracture initiation merits further investigation

# RESERVOIR ENGINEERING DATA REQUIREMENTS

<u>Parameter</u>	<u>Potential Source</u>
Coal rank	Core
Gas content	Canister test (core)
Seam thickness	Log, core
Pressure	Well test, fluid level
Temperature	Log
Cleat spacing	Core
Diffusion coefficient	Canister test (core)
Compressibility	Well test, core test
Desorption isotherm	Core sample
Initial saturations	Well test, production analysis
Permeability	Well test, production analysis
Desorption pressure	Well test, production analysis



# COALBED METHANE SIMULATION

## Reservoir Properties

- Coal Rank
- Gas Content
- Seam Thickness
- Pressure
- Temperature
- Cleat Spacing
- Diffusion Coefficient
- Compressibility
- Desorption Isotherm
- Permeability
- Porosity
- Water Saturation
- Desorption Pressure

## Mathematical Model

Natural Fracture (cleat)

Matrix Block

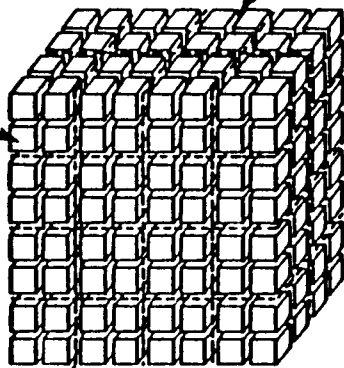

Finite Difference Grid

## Theory of Flow

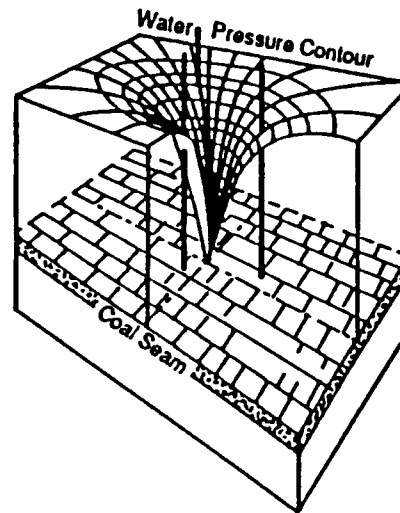

Gas Production  
Water Production

# Permeability vs. Depth Piceance, San Juan, and Warrior Basins

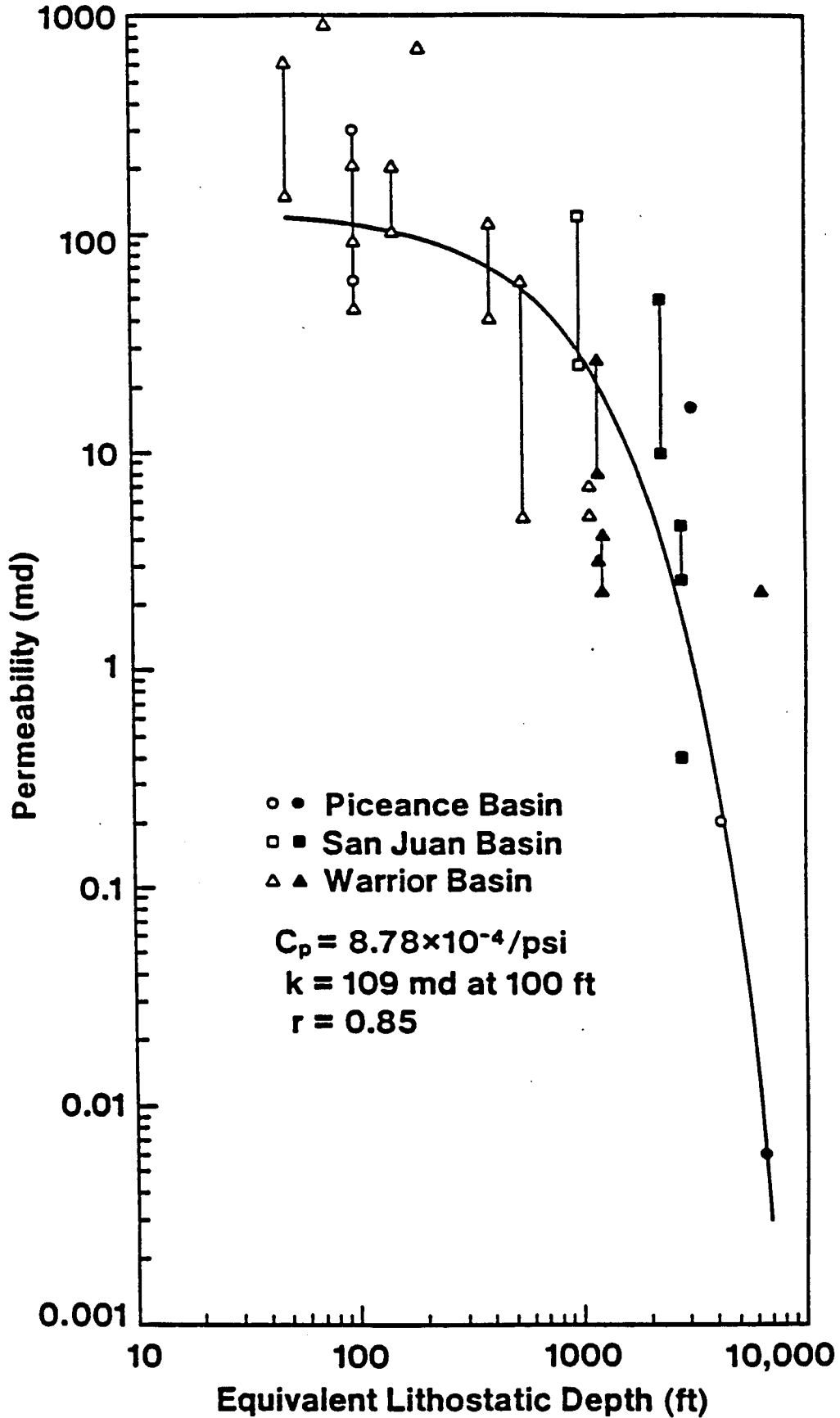

# RELATIVE PERMEABILITY

## Effect on Production

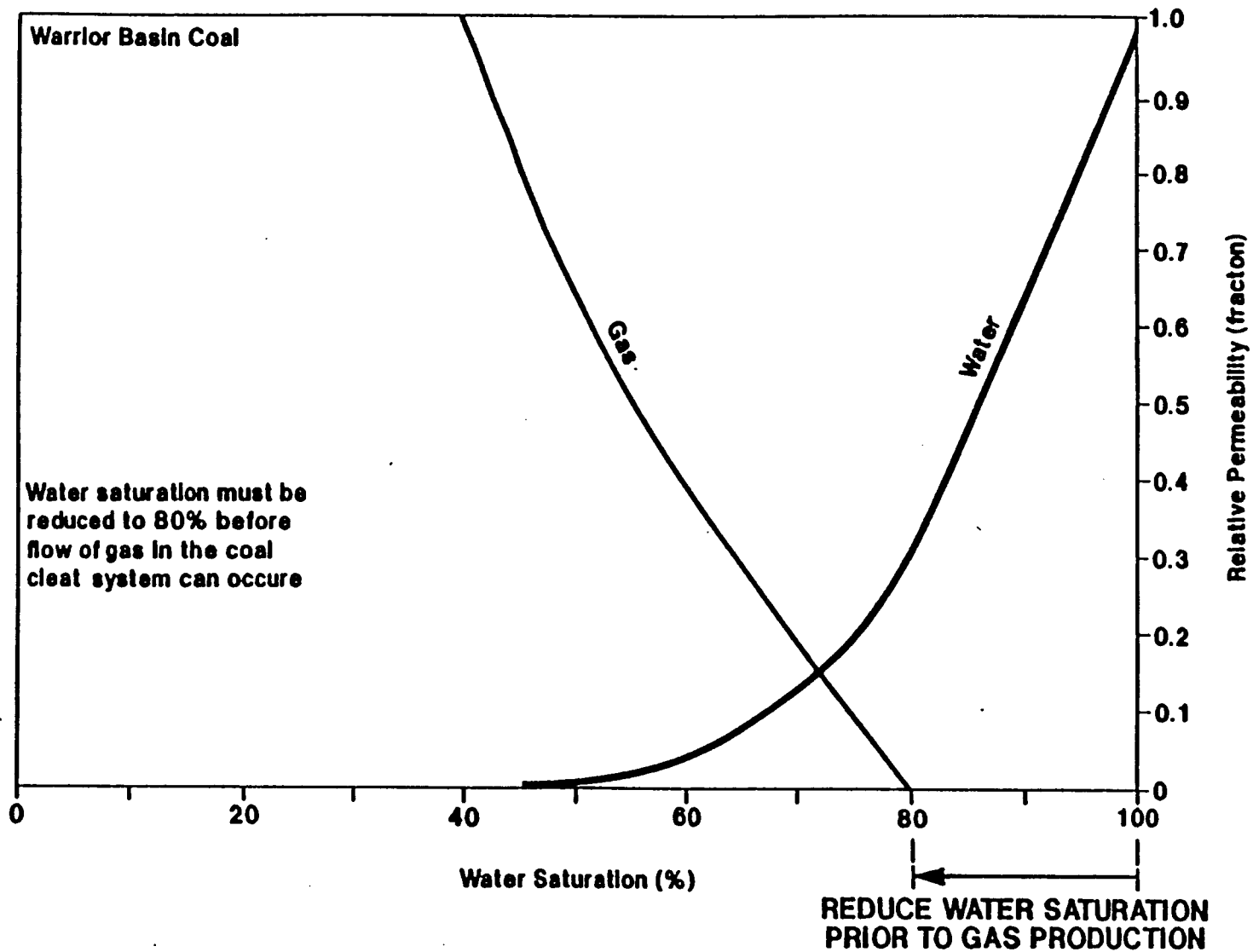

# DUAL POROSITY CHARACTERISTICS OF COAL SEAMS

## DIFFUSIONAL FLOW

- Flow through the coal matrix is a diffusional process.
- This is described by Fick's law.
- The coal matrix has an extremely low flow capacity.
- Due to the low flow capacity but very high storage capacity of the coal matrix, a "dual-porosity" reservoir model is required.

**FIGURE 3. - GAS PERMEABILITY RELATIVE TO WATER SATURATION (22).**

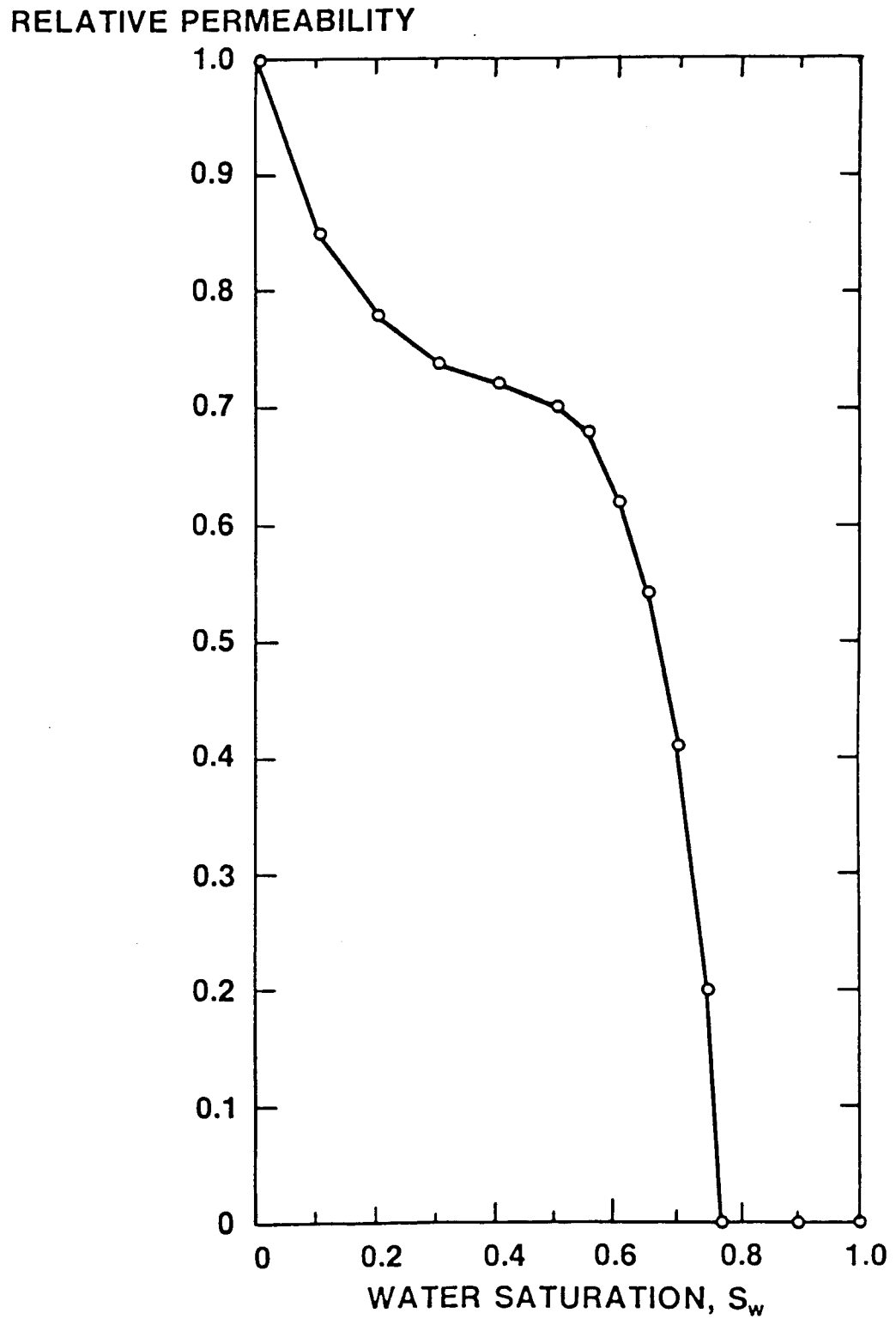

# GAS DESORPTION ISOTHERMS

## ADSORPTION/DESORPTION - BASIC CONCEPTS

- Adsorption – the adhesion of a single layer of gas molecules to the internal micropore surfaces of the coal matrix.
- Desorption – the process whereby adsorbed gas molecules become detached from pore surfaces.
- Langmuir developed a very simple theory of physical adsorption.

# GAS DESORPTION ISOTHERMS

## LANGMUIR COEFFICIENTS

$V_L$  – Maximum adsorptive capacity; the upper limit of adsorption as pressure approaches infinity.

$P_L$  – Pressure at which adsorbed gas concentration is one-half the maximum;  $C = V_L/2$

# Illustration of the Effect of Languir Pressure on Isotherm

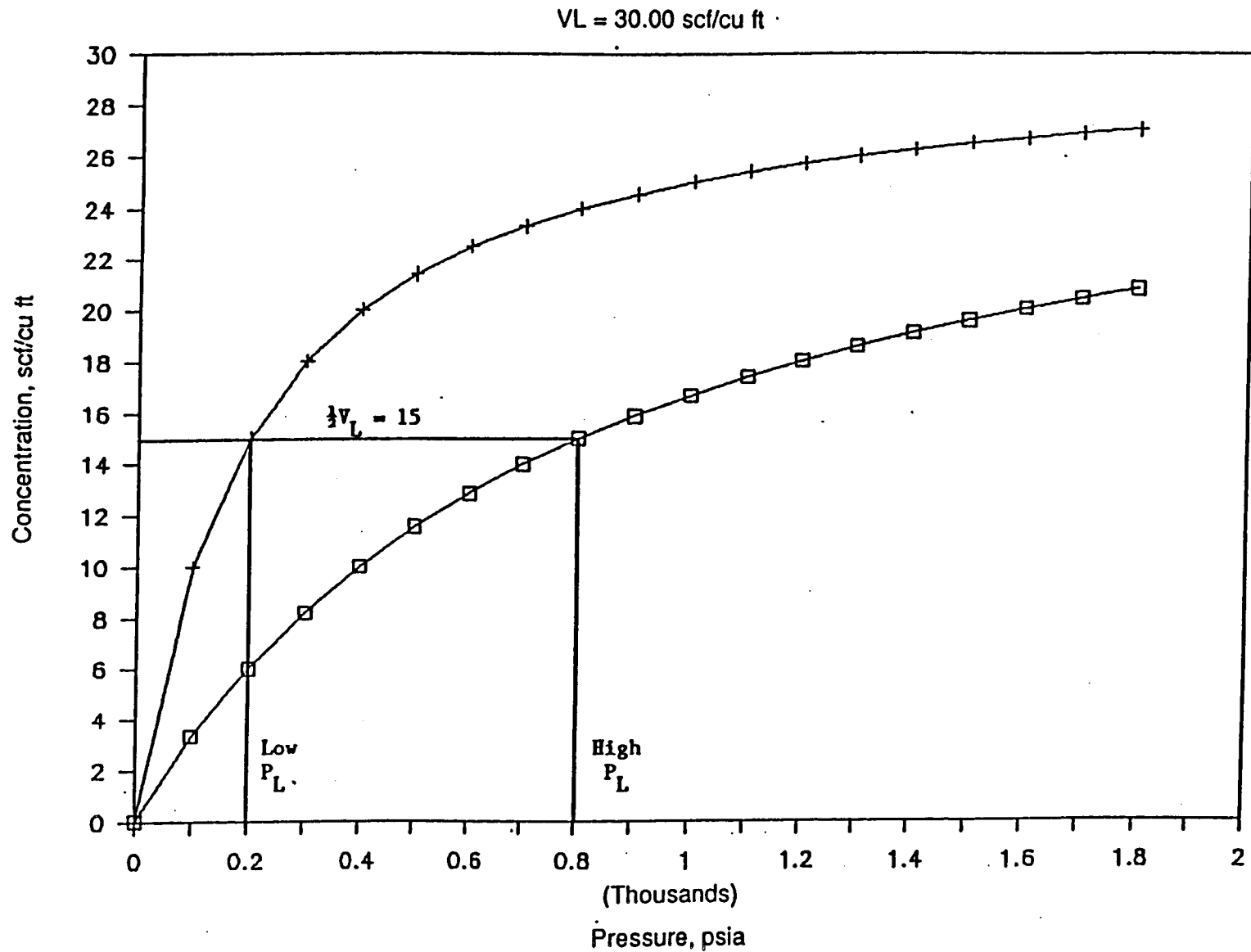



# DESORPTION ISOTHERM

Pocahontas Coal

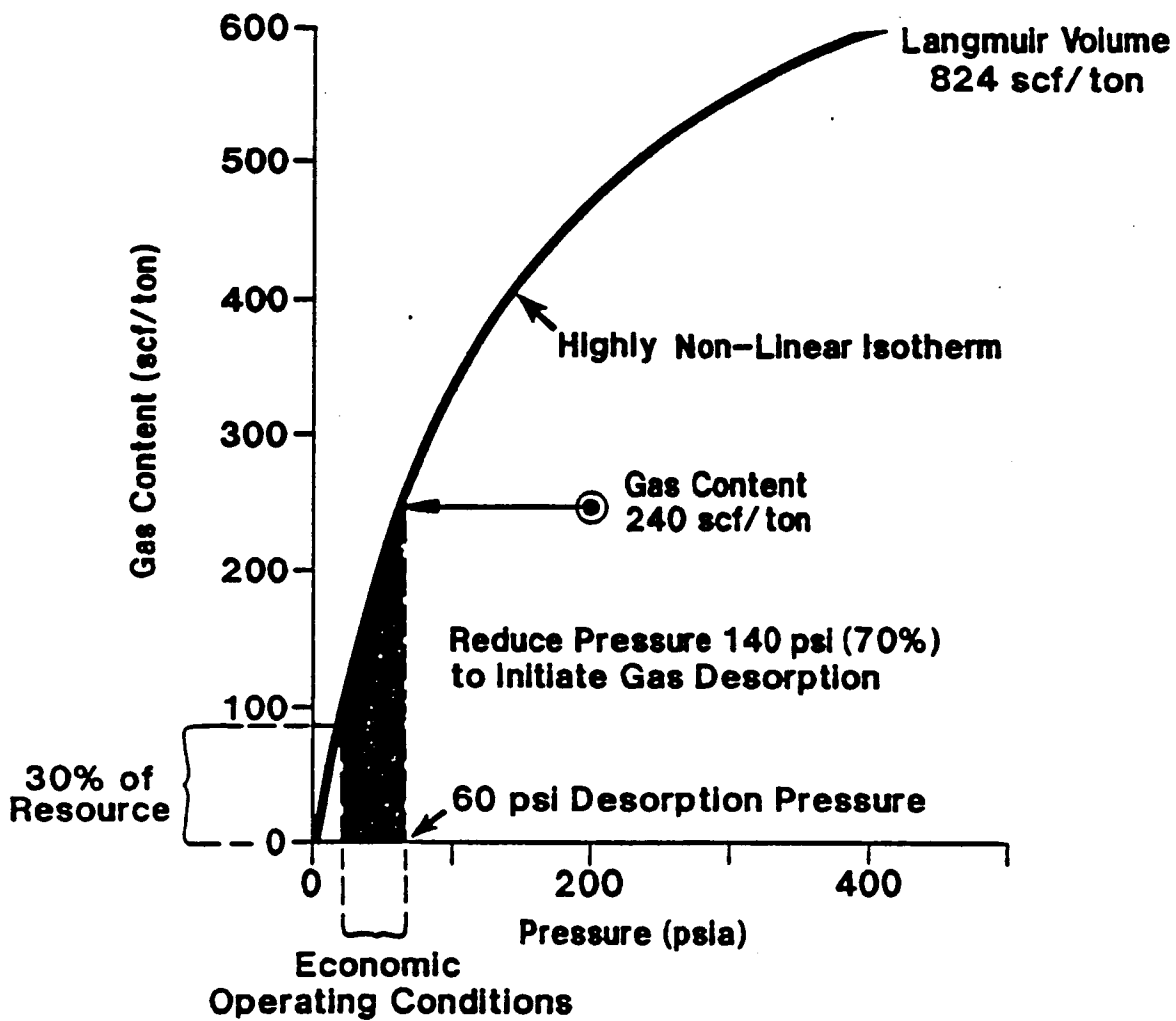

## Example of Desorption Hysteresis and Low Desorption Pressure

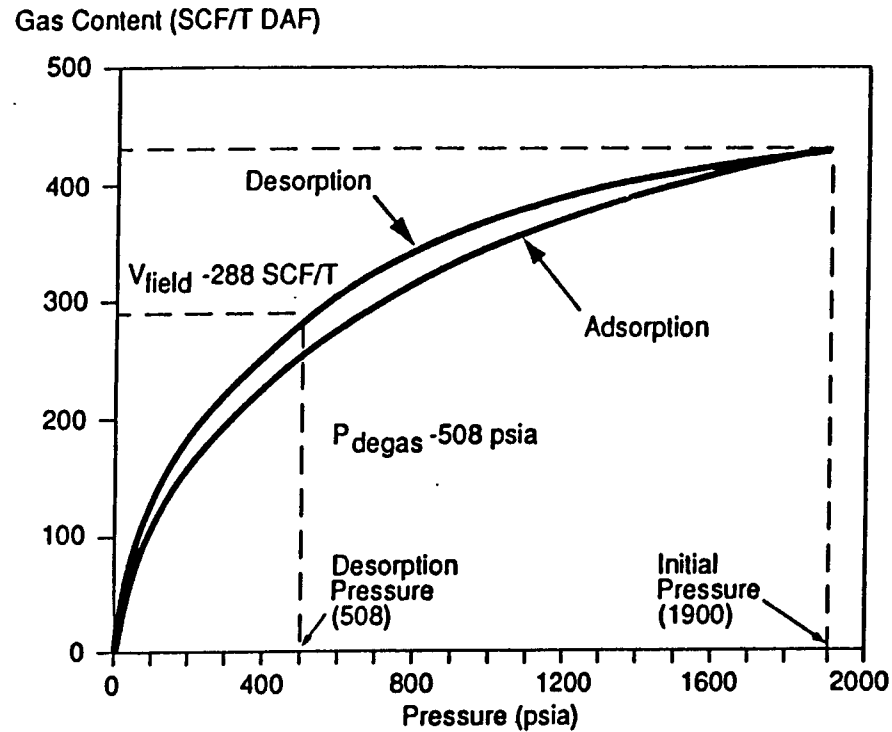

Langmuir adsorption/desorption isotherms for five D Coal Seam core samples from the Red Mountain site, showing average field-measured gas content and corresponding critical desorption pressure.

# High Formation Desorption Pressure Releases More Gas

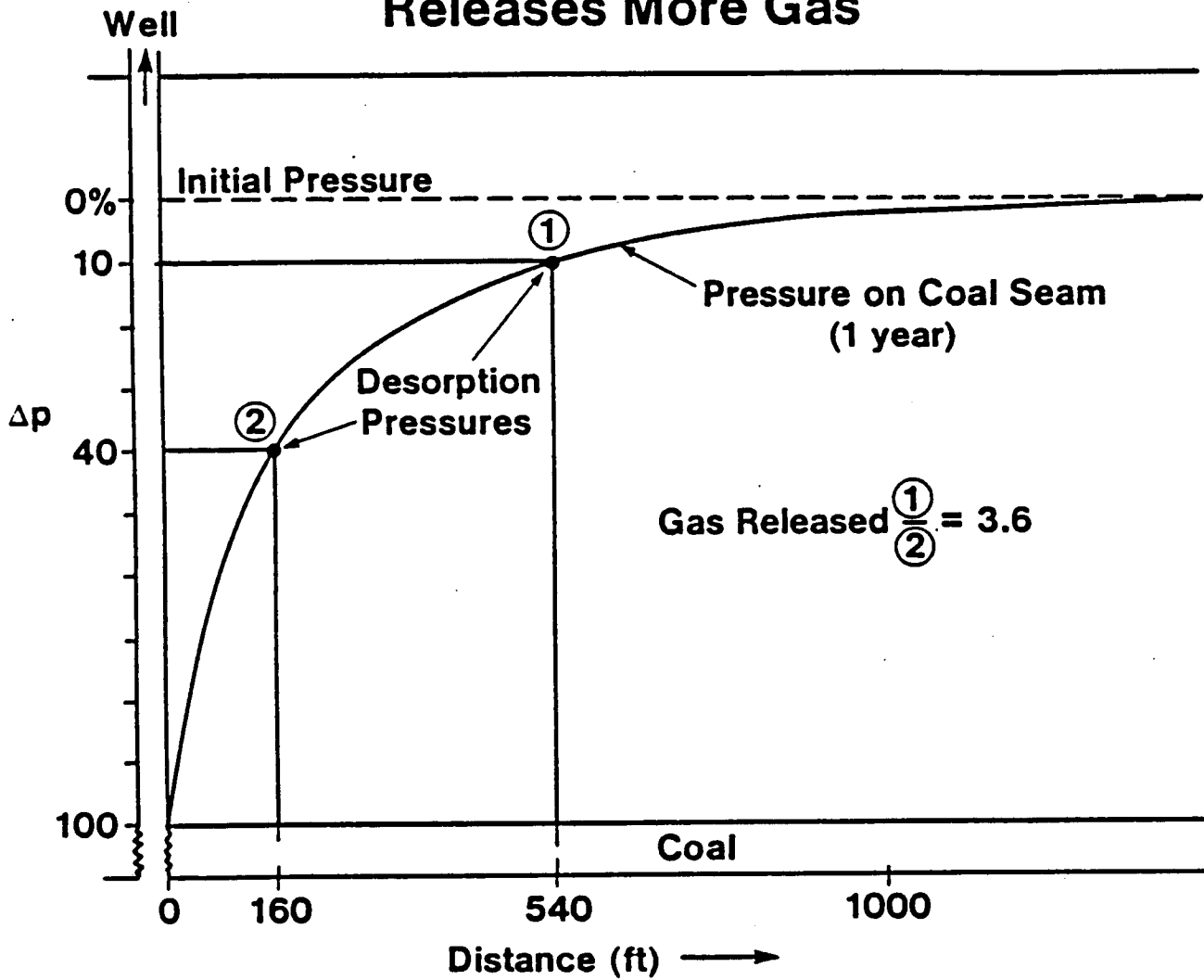

# PROCESSES IN THE TRANSPORT OF COALBED METHANE GAS

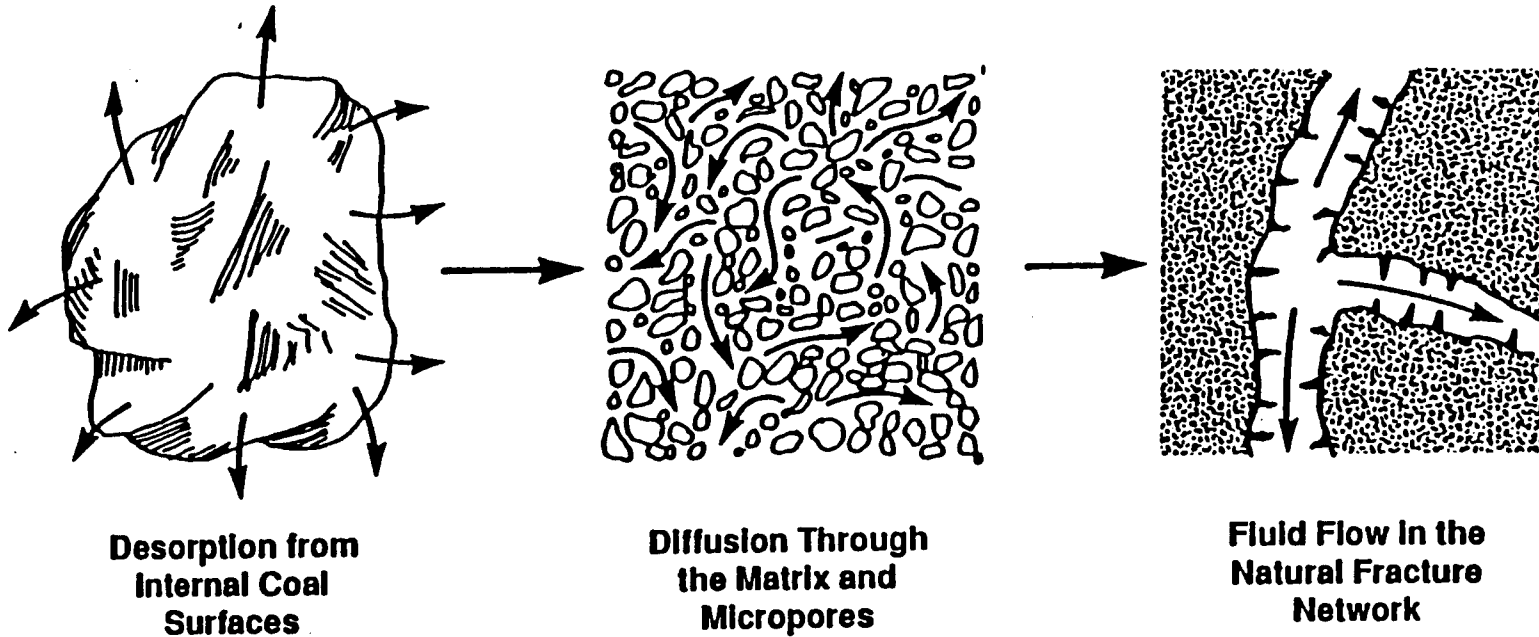

Increasing Size →

# INTERNAL SURFACE AREA OF COAL

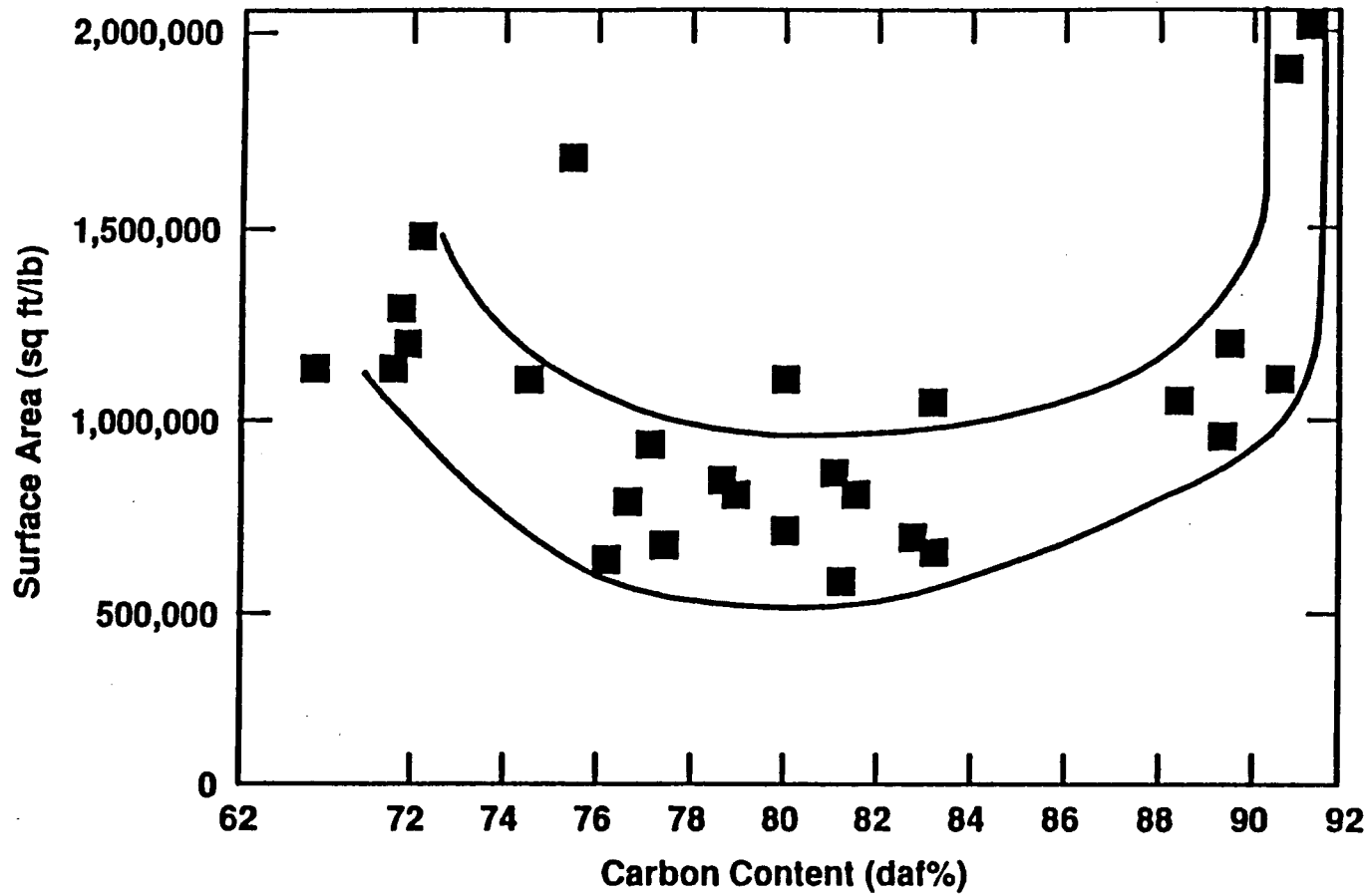

# PRODUCTION RATE Conventional vs. Coalbed

## Conventional Gas Reservoir

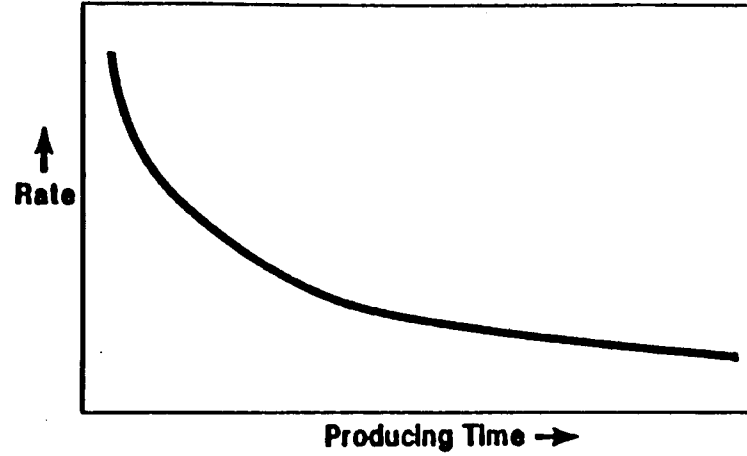
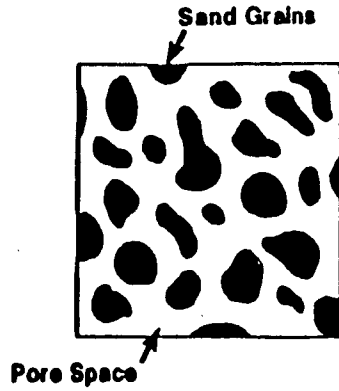

## Coalbed Methane

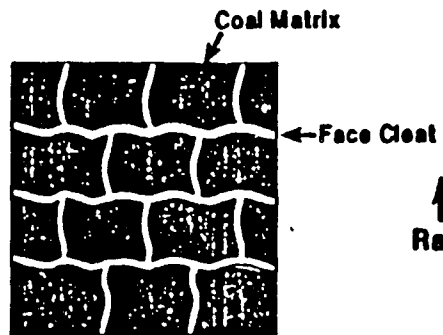

Cleats typically filled with water initially

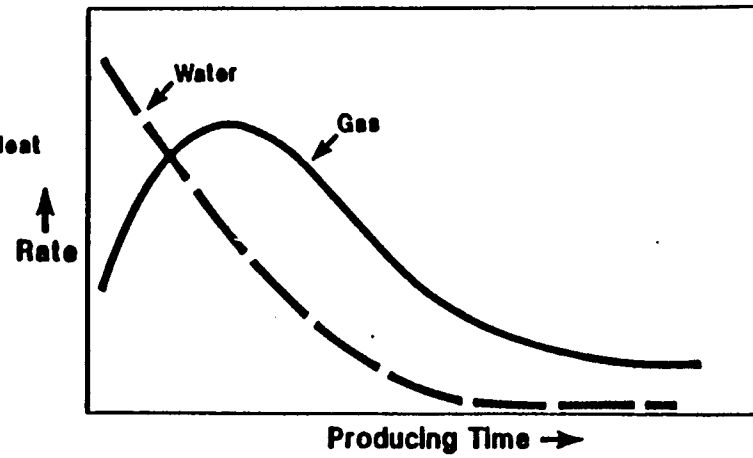

# Illustration of Major Cleat Providing Flow Path to Wellbore

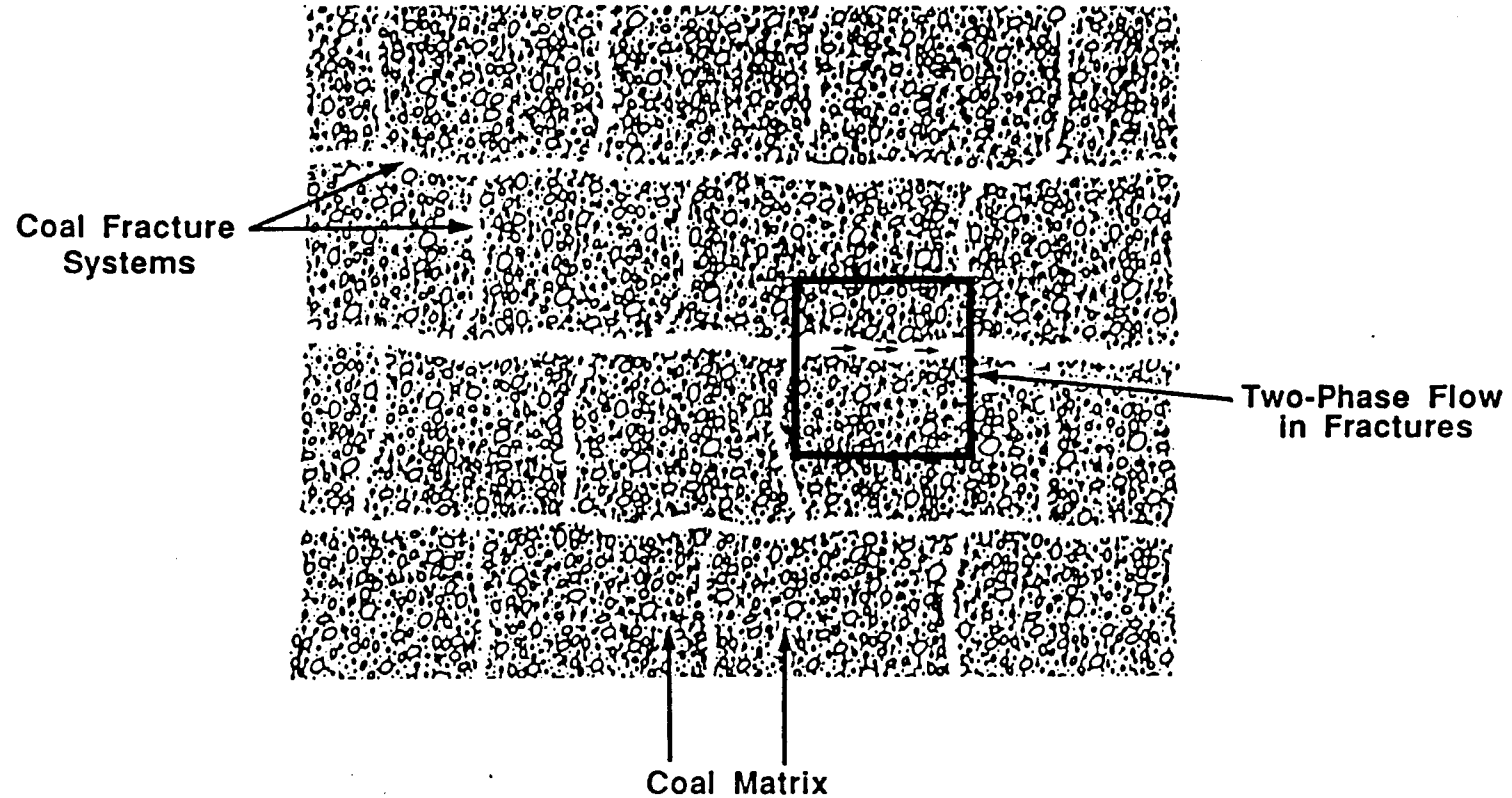

# DUAL POROSITY CHARACTERISTICS OF COAL SEAMS

## COAL MATRIX PROPERTIES

- The coal matrix contains a very fine micropore structure.
- The coal matrix provides a very high storage capacity for methane gas.
- 51%  $\phi$  (100% saturation) @ 400 psi.
- 13%  $\phi$  (100% saturation) @ 1,600 psi.
- Methane molecules are physically attached (i.e., adsorbed) to the micropore walls of the coal matrix.



# Three Stages of Coalbed Methane Production

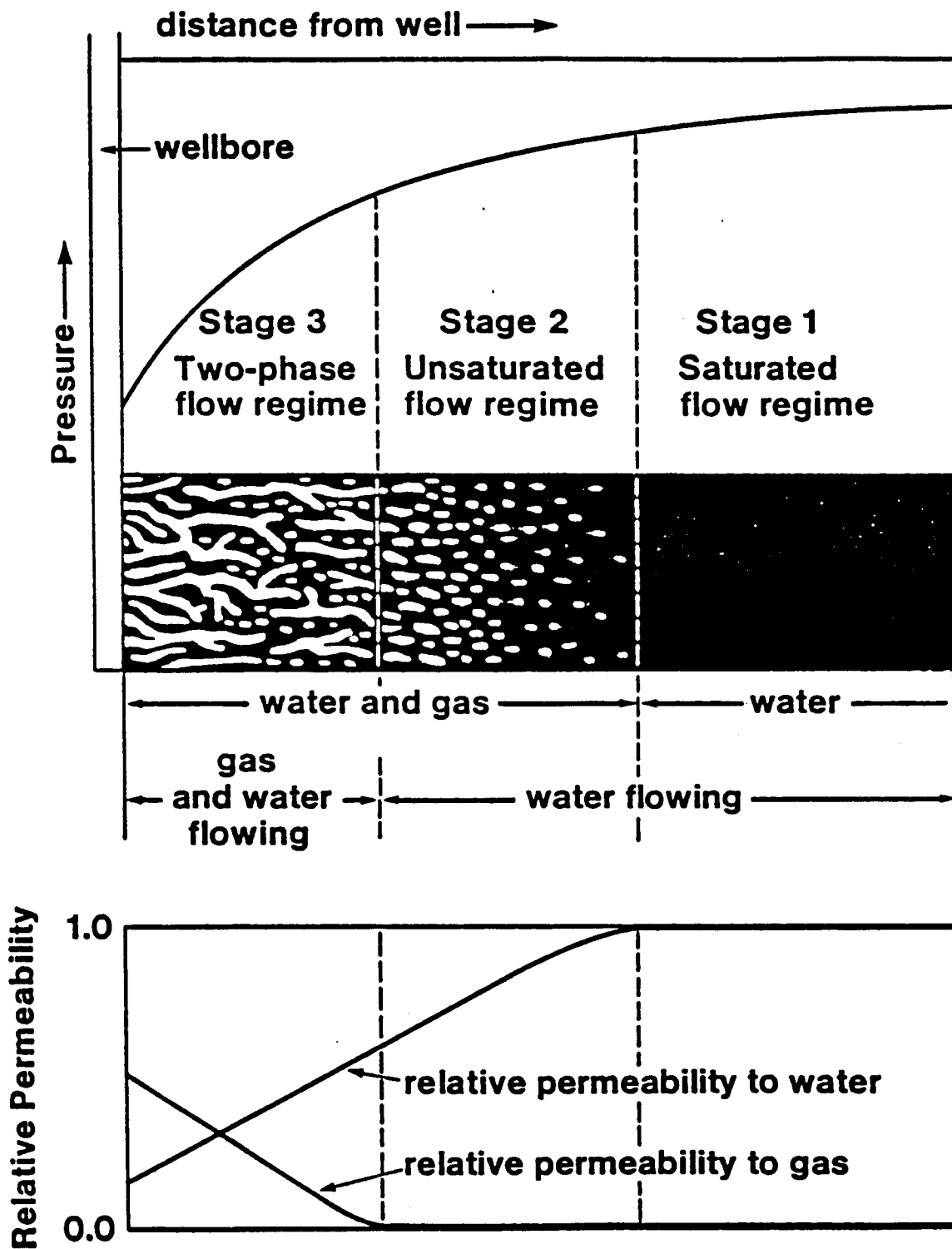

# METHANE DEPLETION OCCURS UNDER TWO-PHASE FLOW CONDITIONS

Absolute Permeability  
(single-phase flow)

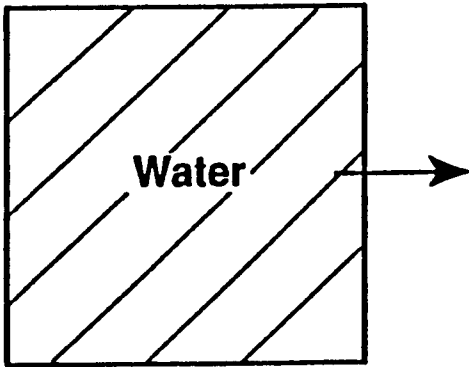

Relative Permeability

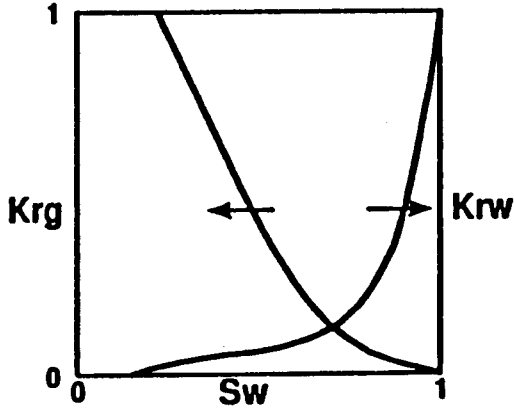

Effective Permeability to  
Gas and Water

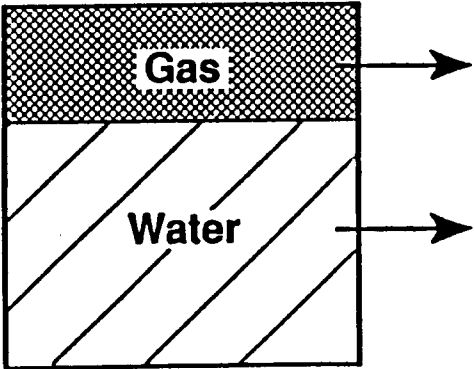

# Illustration of Matrix Gas Transport

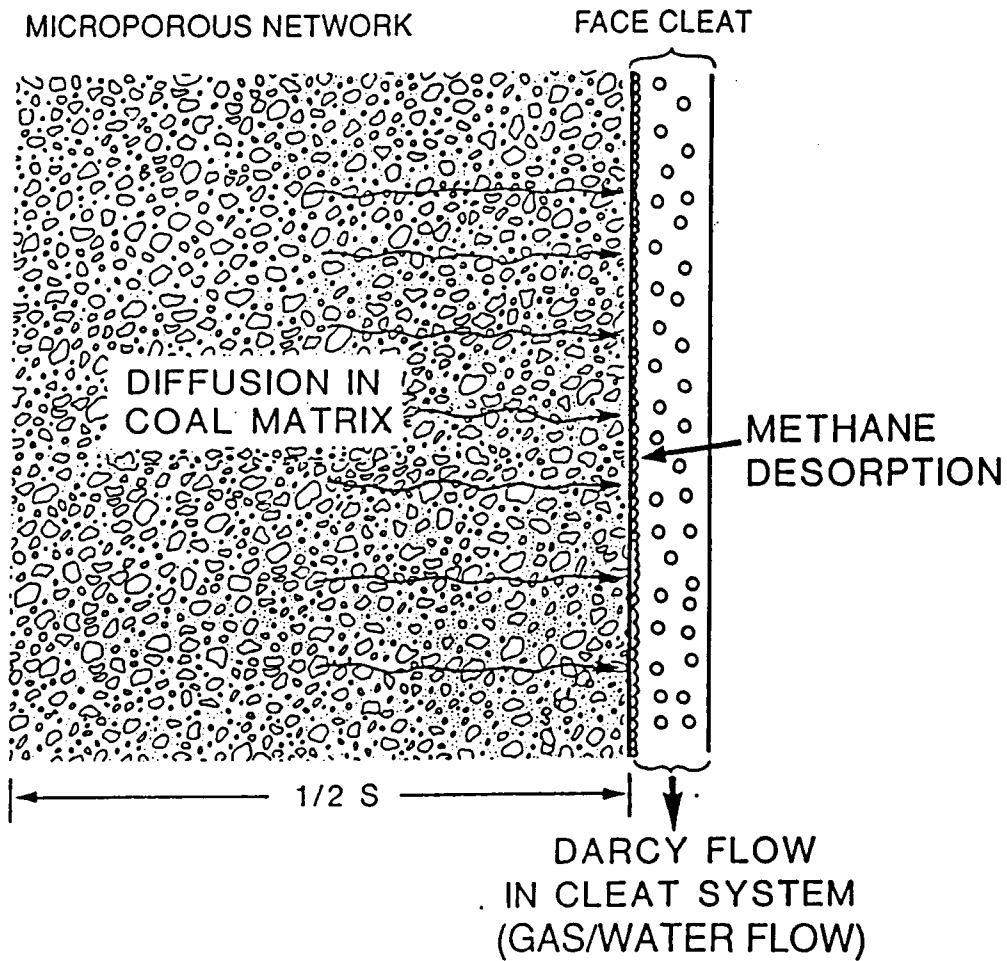

Sorption Time

$$\tau = \frac{S^2}{8 \pi D}$$

Boundary Condition at Cleat-Matrix Interface:

$$C = C(P_i)$$

# Illustration of Molecular Diffusion in Coal Matrix

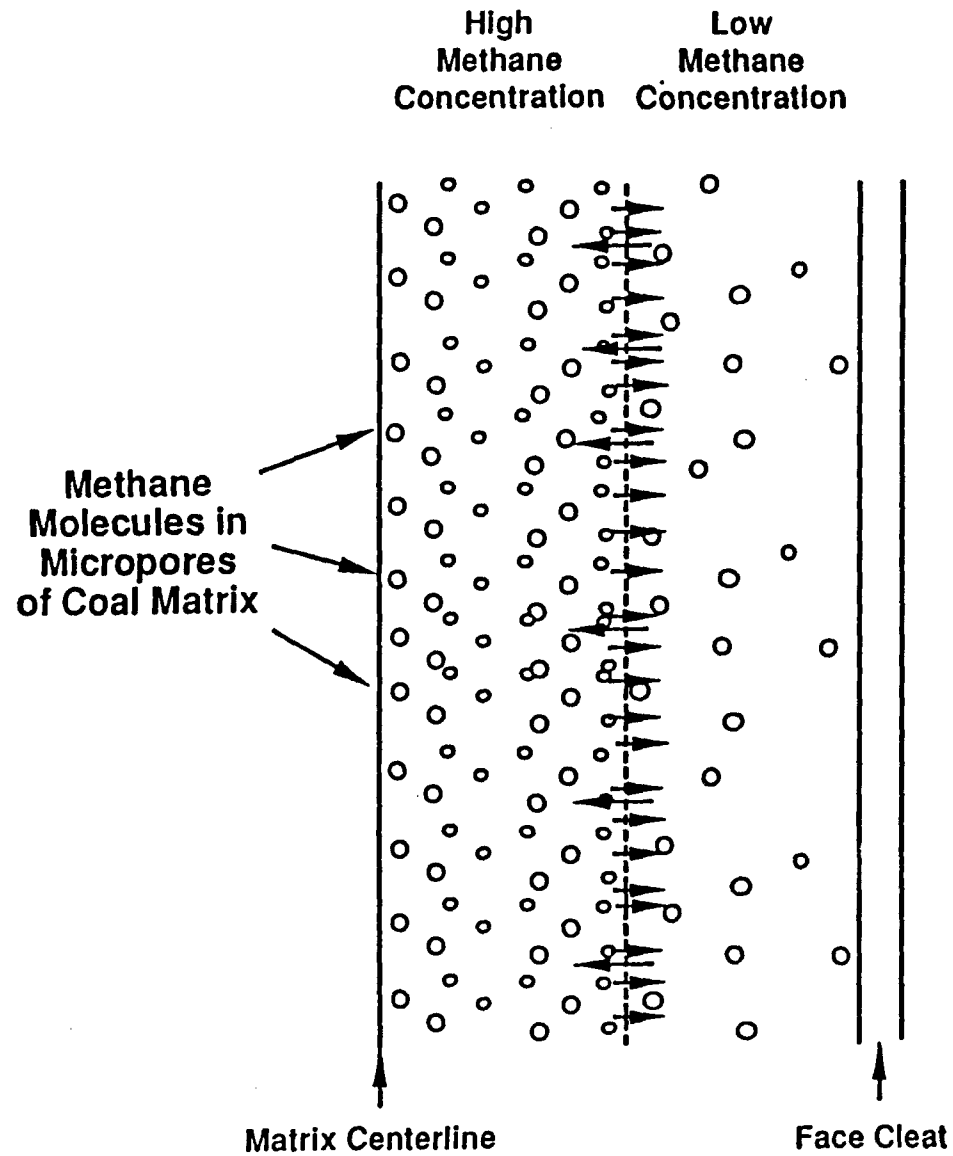

# Dual Porosity Characteristics of Coalbeds

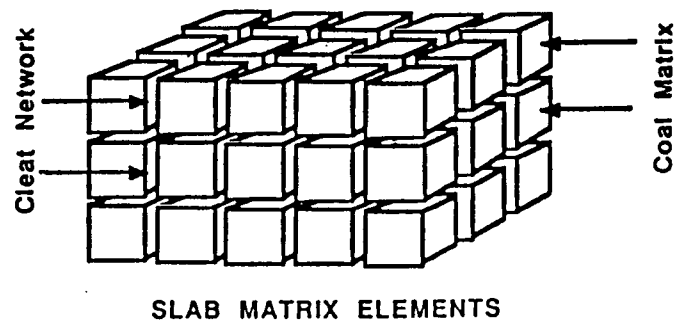
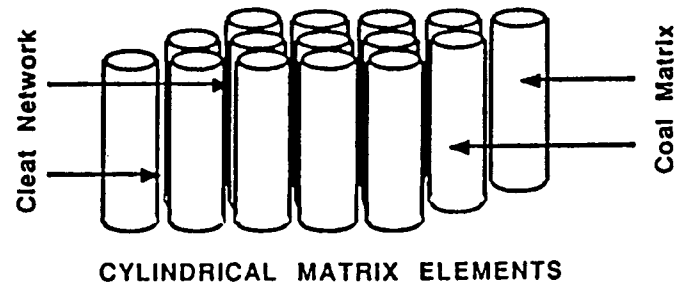
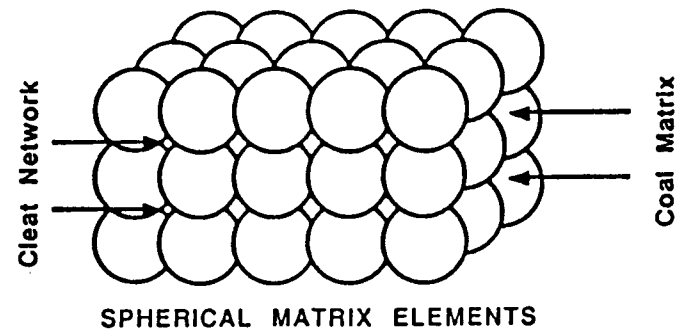
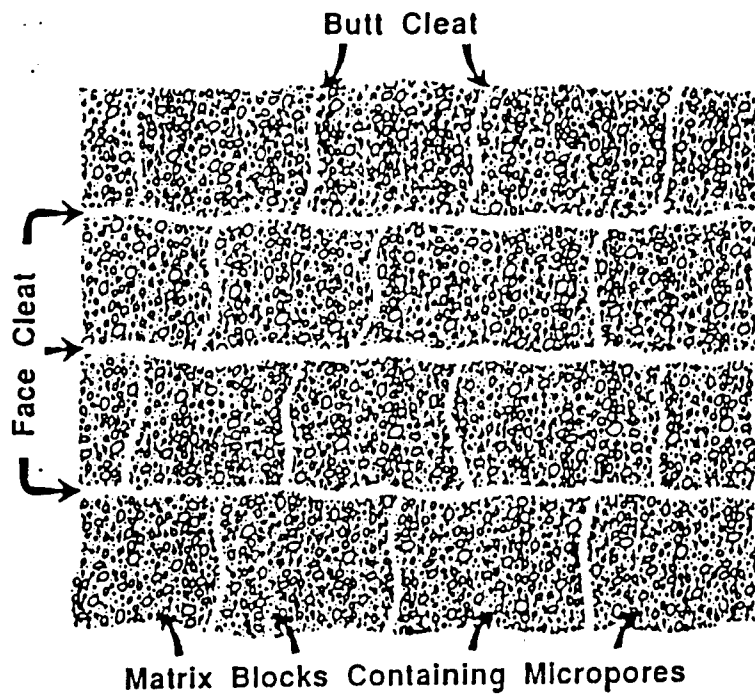

Source: Kolesar and Ertekin, SPE 15233, Louisville, Ky, 1986.

Exhibit 25

# Illustration of Gas and Water Flow in Coal Cleats

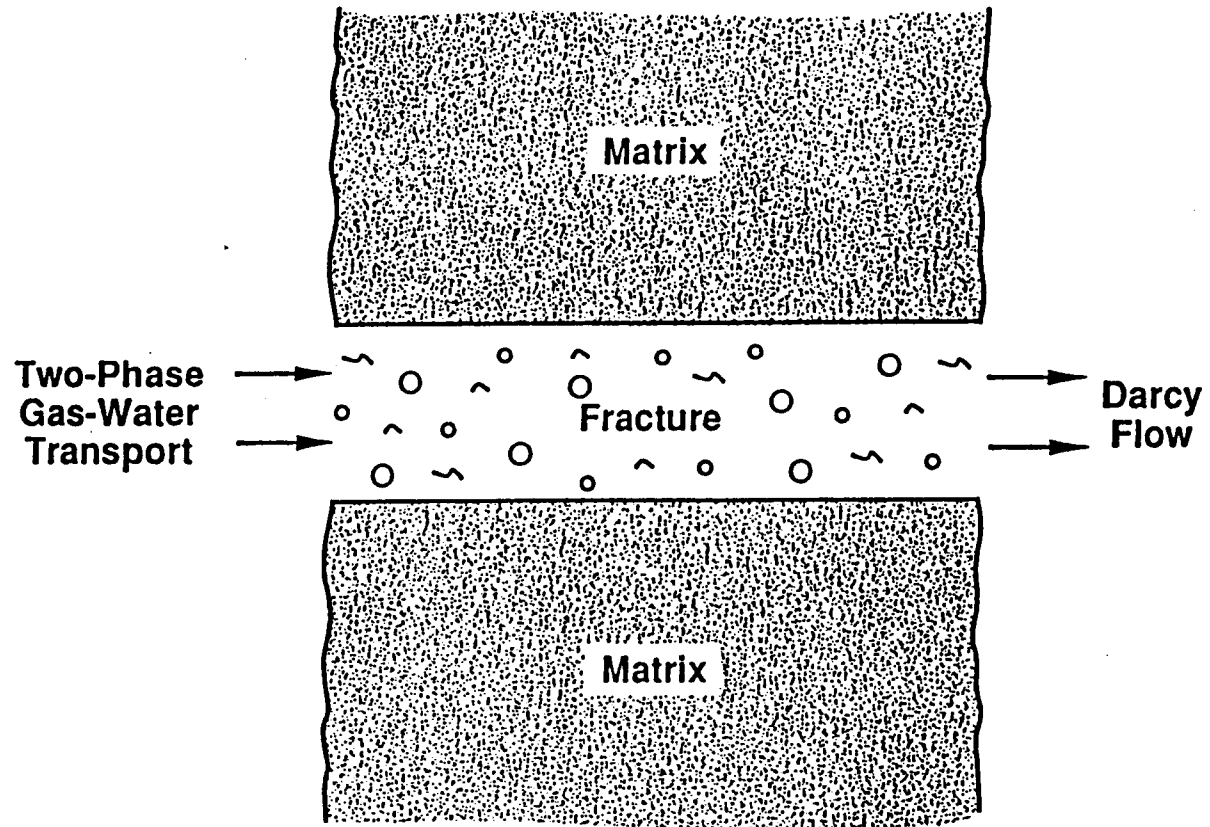

# ILLUSTRATION OF MOLECULAR DIFFUSION IN COAL MATRIX

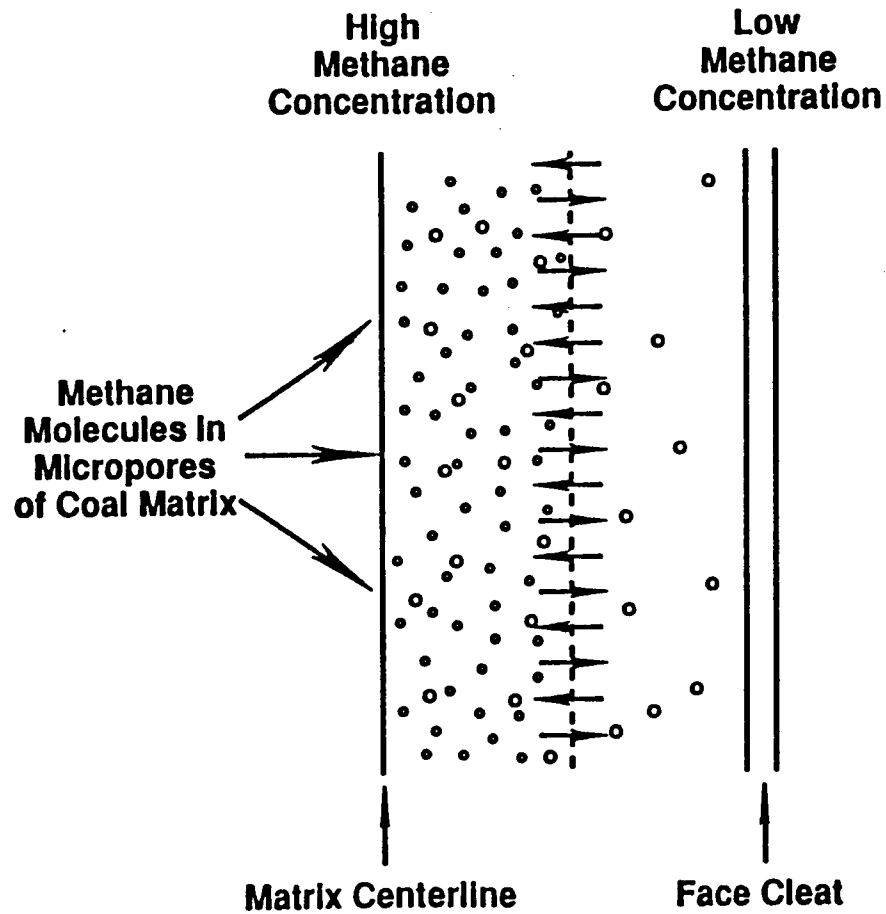

# **TYPES OF COMPLETION**

## **1. VERTICAL WELL**

**A. OPEN HOLE**

**B. CASED HOLE**

**C. CASED/OPEN HOLE**

## **2. GOB WELL**

## **3. HORIZONTAL BOREHOLE**



Total Well Costs

#402,000

#431,000

EARLY OPENHOLE

OPENHOLE CAVITY

CASED HOLE  
FRACTURE STIMULATED

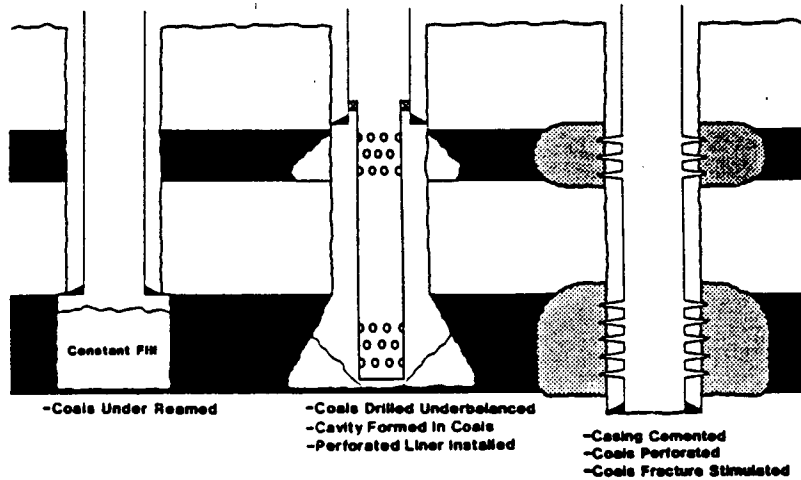

Figure 2 - Completion Diagram

Fruitland Coal  
Northeast Bianco Unit #403

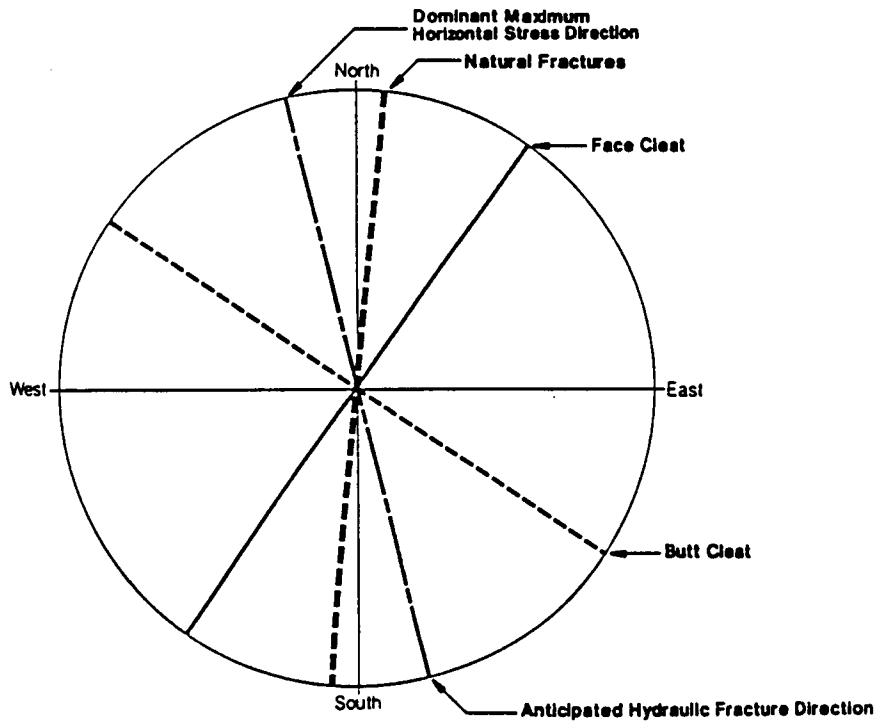
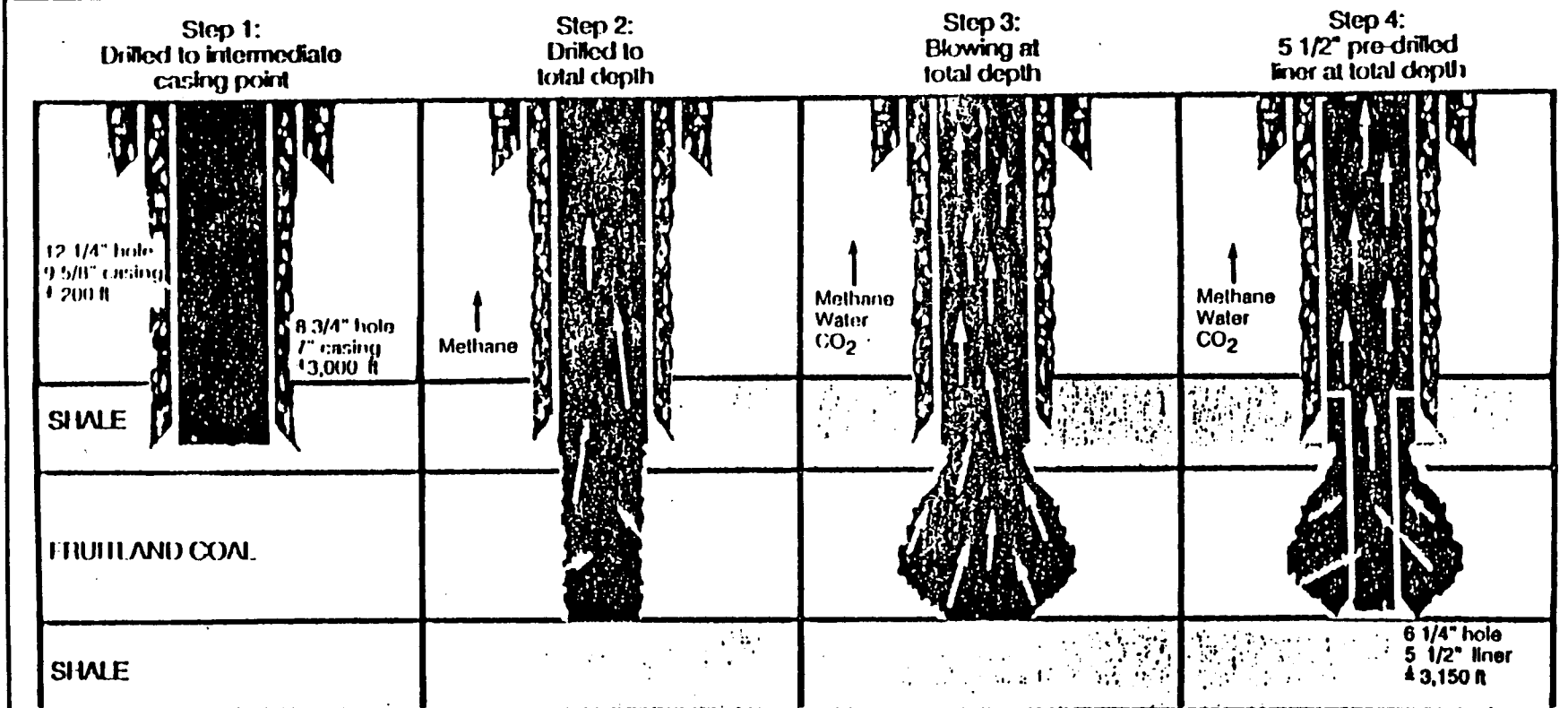

Figure 3 - Orientation Rose Diagram

# Drilling a high potential well

FIGURE 3



(Drilling Contractor, 12/88-1/89)

**TYPICAL WELL COSTS**  
(\$1000)

\* Thick Coal Seams

\* Well Depth 3000 feet

<u>Intangibles</u>	<u>OPENHOLE CAVITY</u>	<u>CASED HOLE</u>
Location	15	10
Drilling	53	55
Stimulation	0	120
Completion	163	61
<u>Tangibles</u>		
Tubulars	80	63
Wellhead	12	12
Production Equipment	<u>80</u>	<u>110</u>
<b>TOTAL</b>	<b>\$403</b>	<b>\$431</b>

## CASED HOLE

**Purpose: Selective Zone Stimulations. Maintain Hole Stability,  
Fracture Stimulate Through Formation Damage**

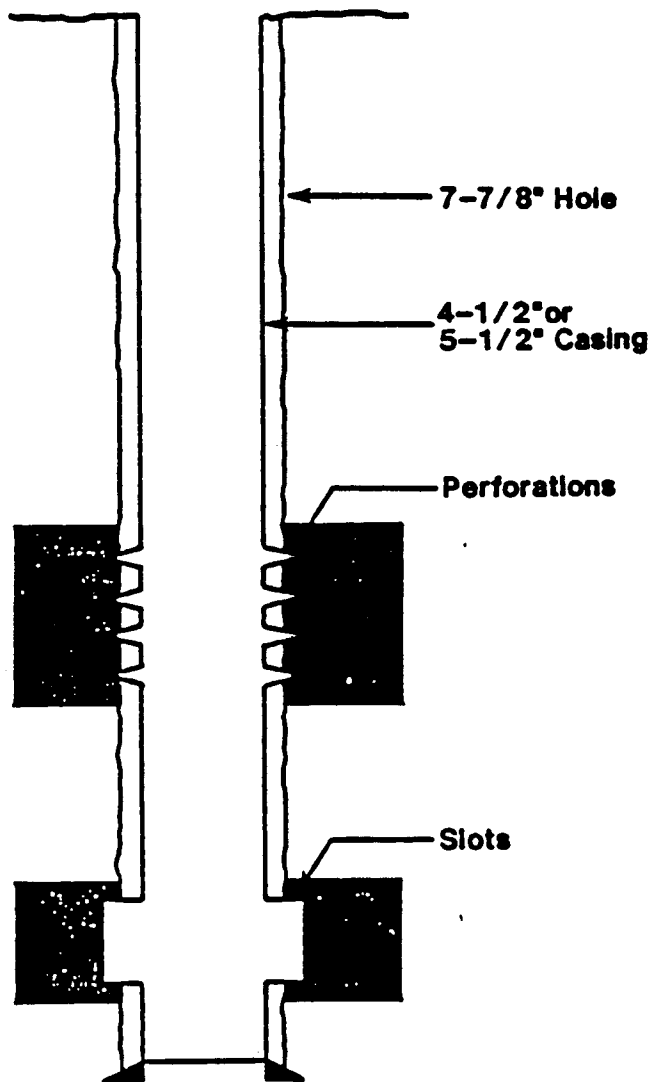

**Drill Through Coals**

**Cement Casing Across Coals**

**Access Coals**

**Fracture Stimulate Through Damage**

# OPENHOLE TECHNIQUES

Purpose: Prevent Formation Damage

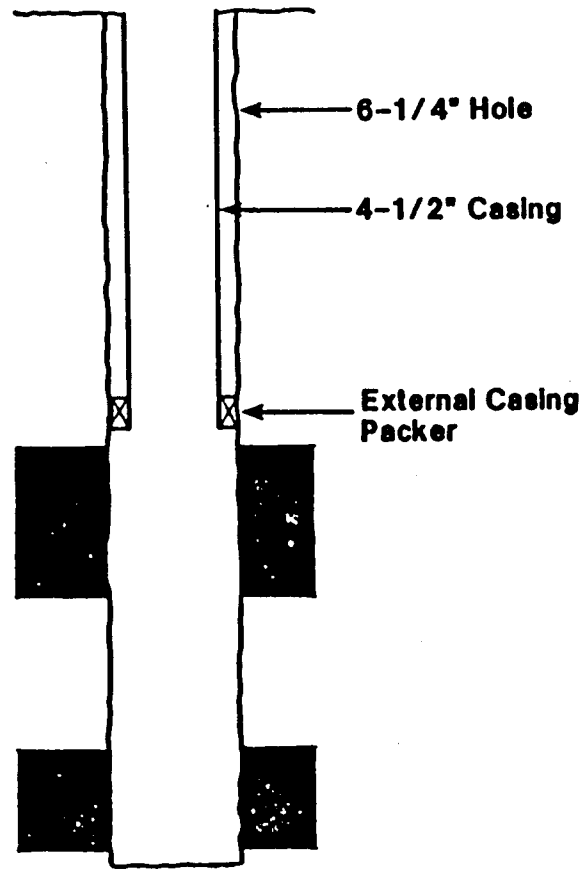

Drill Through Coal  
Set Casing Above Coal Using External  
Casing Packer

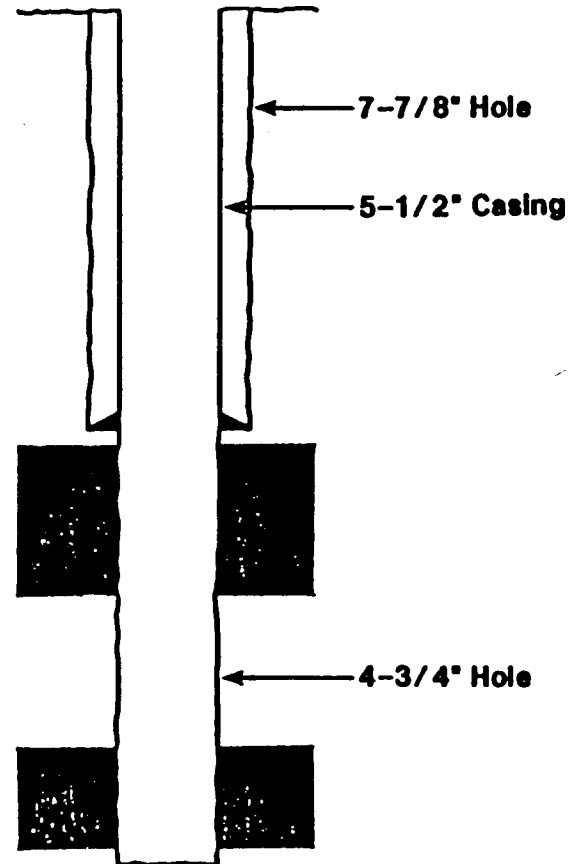

Stop Drilling Before Penetrating Coal  
Set Casing  
Drill Into Coal Seams

## OPENHOLE CAVITY

**Purpose: Prevent Formation Damage and Increase Permeability**

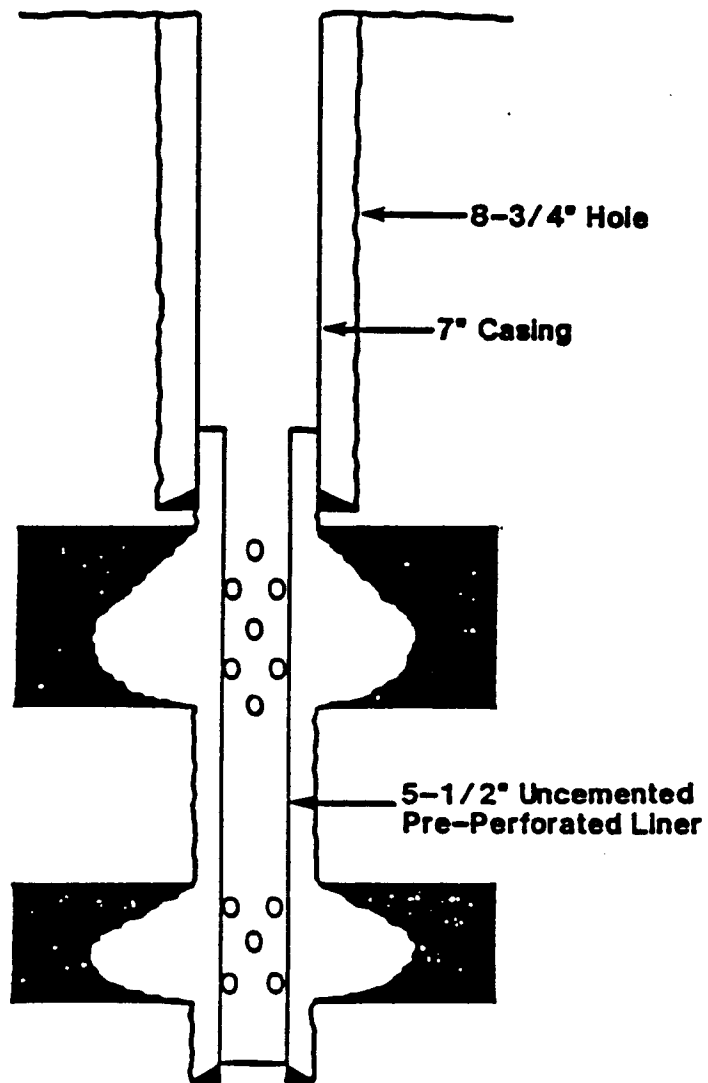

**Place Cemented Casing Above Coals  
Drill Through Coals "Underbalanced"  
Create Cavity  
Place Uncemented Pre-Perforated Liner**

# COMPARISON OF A HYDRAULIC FRACTURE AND DRAINHOLE

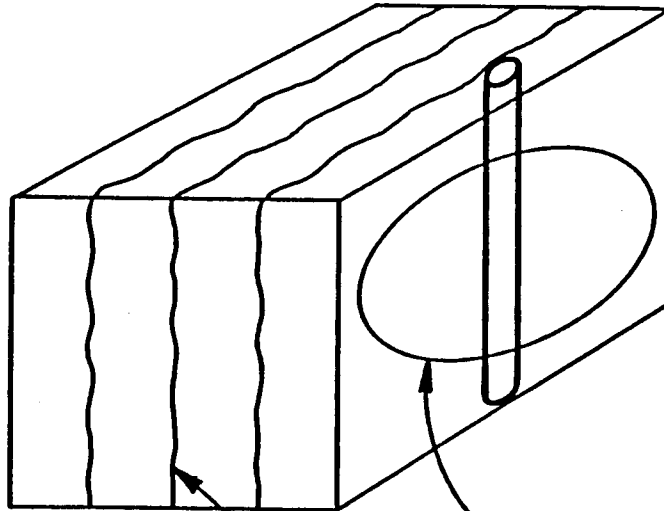

**FACE CLEAT**

**Hydraulic Fracture**

**Hydraulic Fracture Parallel to Face Cleat**

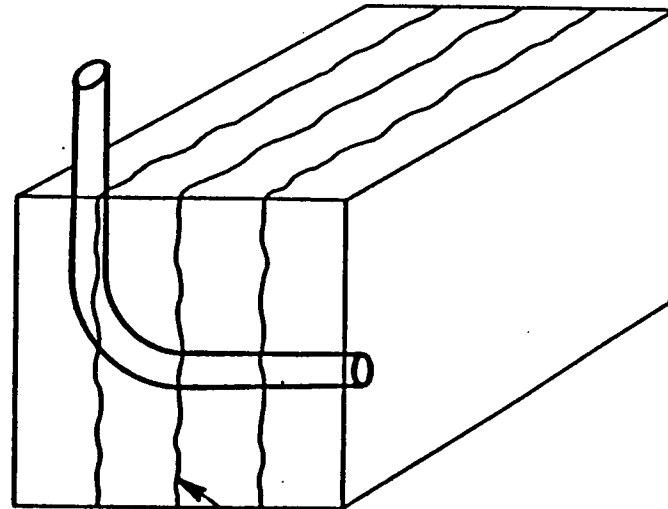

**FACE CLEAT**

**Horizontal Drainhole Perpendicular to Face Cleats**

# COALBED METHANE RESOURCES OF THE U.S.

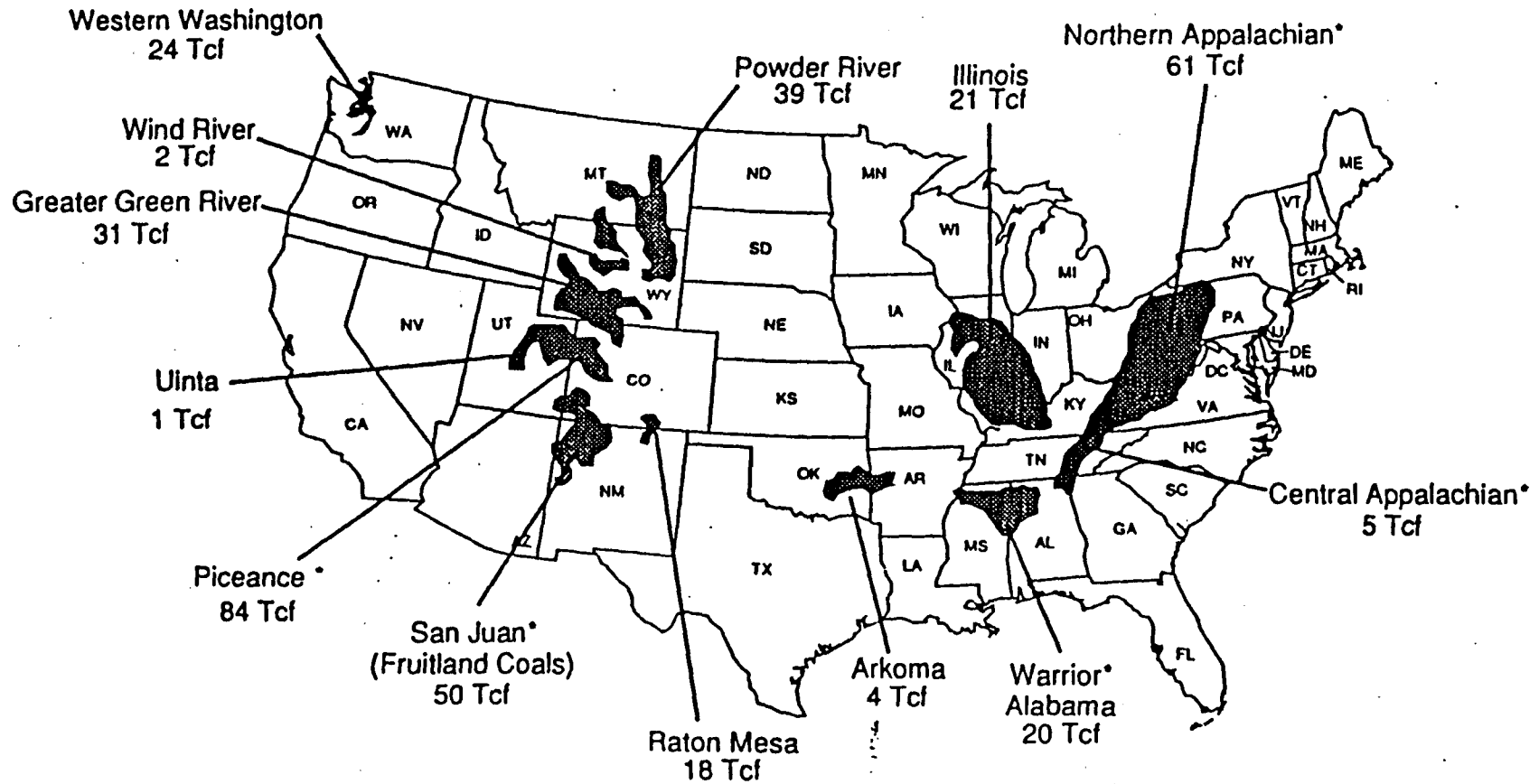

\*Detailed Geologic Appraisals Completed by GRI/ICF-Lewin



**Table 14. Estimated coalbed methane resources, selected basins in conterminous United States.**

PGC Region	Basin	PGC Province No.	State(s) included in evaluation	Estimated total methane in place (Tcf)	Estimated most likely recoverable resource, all resource categories (Tcf)
Eastern	Appalachian central*	P-120	KY, MD, TN, WV, VA	10.0 to 48.0 (1) 5 (2)	25 (2)
	Appalachian northern*	P-120	KY, MD, OH, PA, WV	61.0 (1)	
	Warrior (Black Warrior)*	P-150	AL, MS	5.0 to 10.0 (1) 19.8 (2) 39.0 (3)	8.0 (2) 15.0 (3)
	Illinois	P-220	IL, IN, KY	5.2 to 21.1 (1)	0.4 (4)
	Arkoma	P-410	AR, OK	1.6 to 3.6 (1)	(not estimated)
Western	Powder River	P-510	MT, WY	5.9 to 39.4 (1)	(not estimated)
	Wind River	P-520	WY	0.5 to 2.2 (1)	(not estimated)
	Greater Green River	P-530	CO, WY	0.2 to 30.9 (1)	(not estimated)
	Piceance*	P-540	CO	30.0 to 110.0 (1) 83.9 (2)	29.7 (2)
	Uinta/Wasatch Plateau	P-540	CO, UT	0.2 to 0.8 (1)	(not estimated)
	Raton Mesa (Raton)	P-545	CO, NM	8.0 to 18.4 (1)	(not estimated)
	San Juan*	P-555	CO, NM	1.8 to 31.0 (1) 50 (Fruitland coals only) (2)	27 (2)
	Western Washington	P-600	WA	3.6 to 24.0 (1)	(not estimated)
<b>TOTAL ESTIMATED METHANE IN PLACE FOR ASSESSED BASINS</b>				133 to 448	
<b>TOTAL ESTIMATED RECOVERABLE METHANE (most likely estimate) FOR ASSESSED BASINS ONLY</b>					90.1 to 97.1

\*Coalbed methane production known to be established

- (1) DOE MRCP (TRW)
- (2) GRI/ICF-Lewin Energy
- (3) University of Alabama
- (4) Potential Gas Committee

## Comparison of Gas Storage for Coal and Sandstone vs. Depth

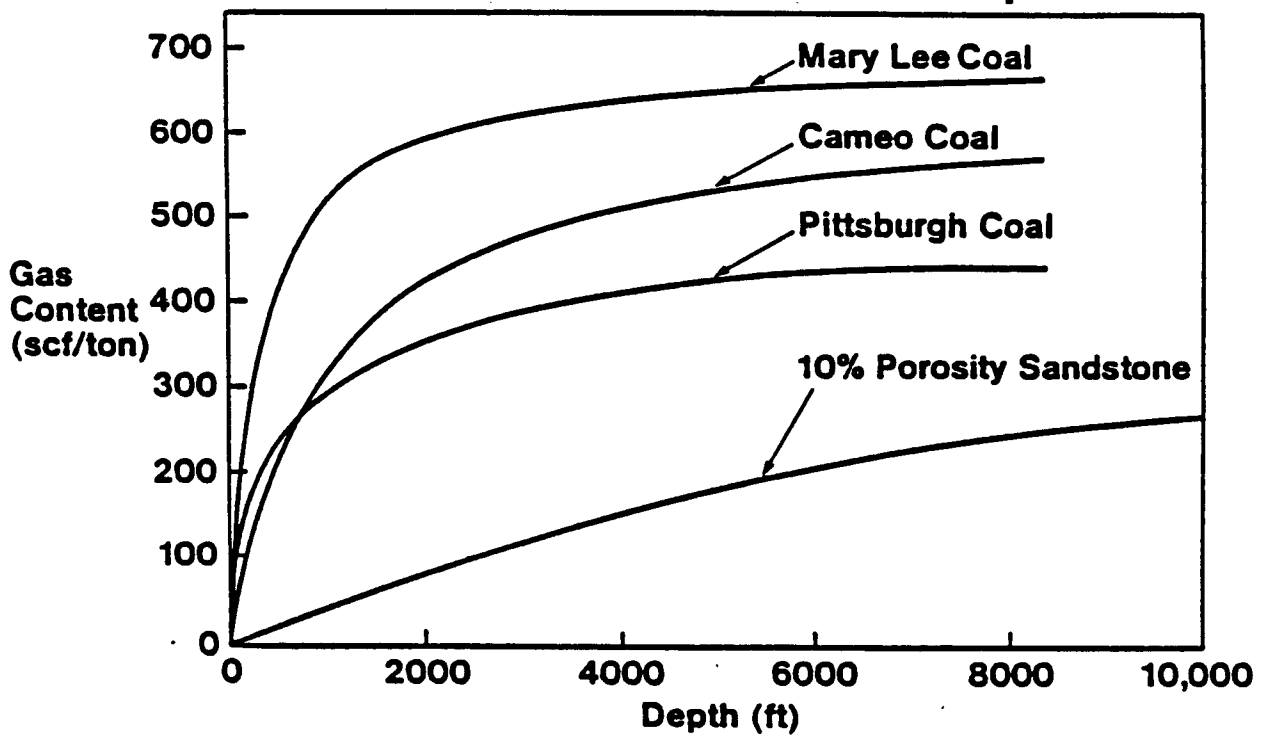

## Coal Has A High Gas Storage Capacity

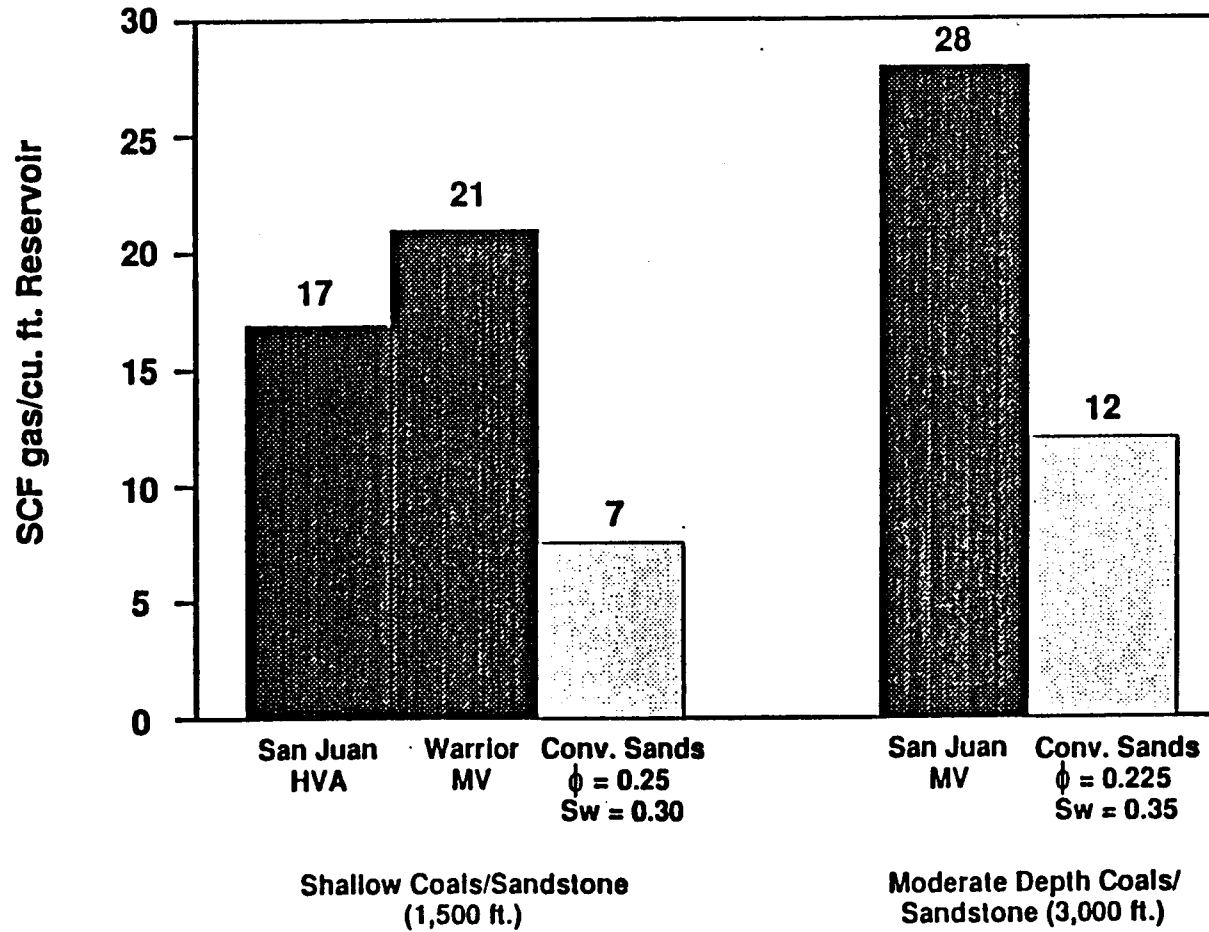

# STRUCTURAL COMPARISON

## Conventional Gas Sand

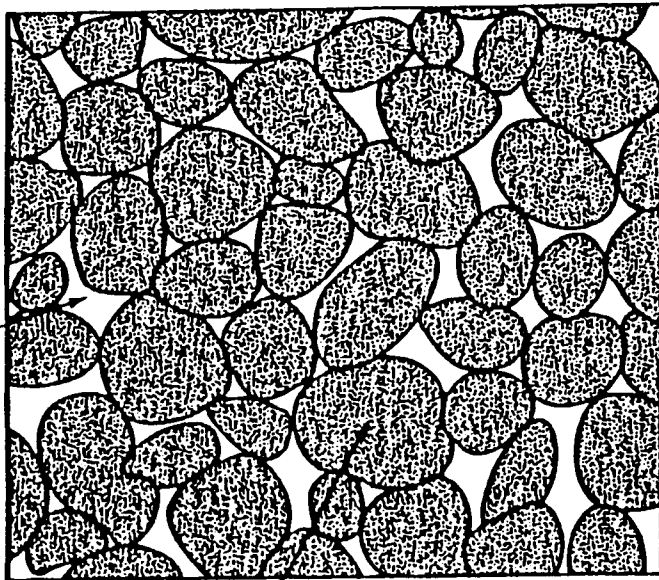

Gas filled porosity

Sand grain

## Coalbed

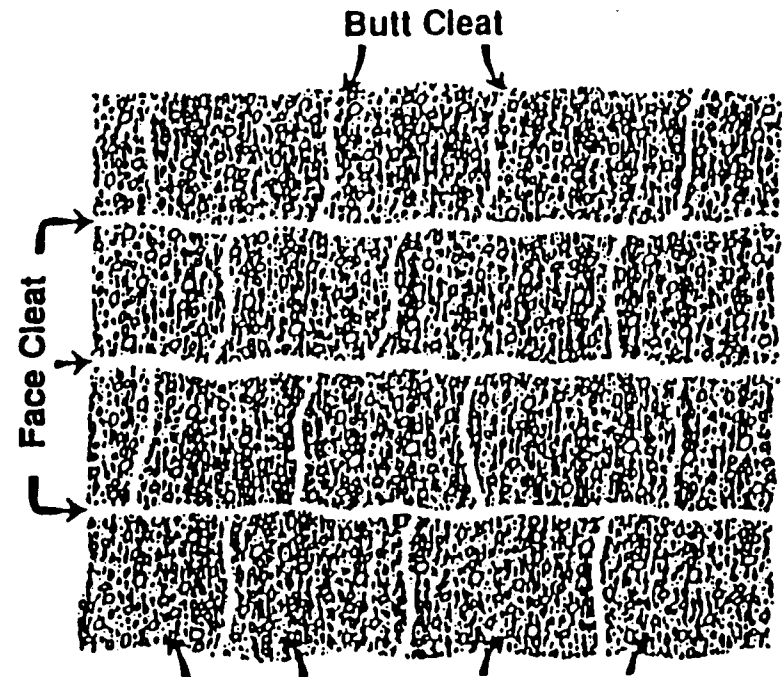

Butt Cleat

Face Cleat

Matrix Blocks Containing Micropores

# PERMEABILITY CONVENTIONAL VS. COALBED

## Conventional

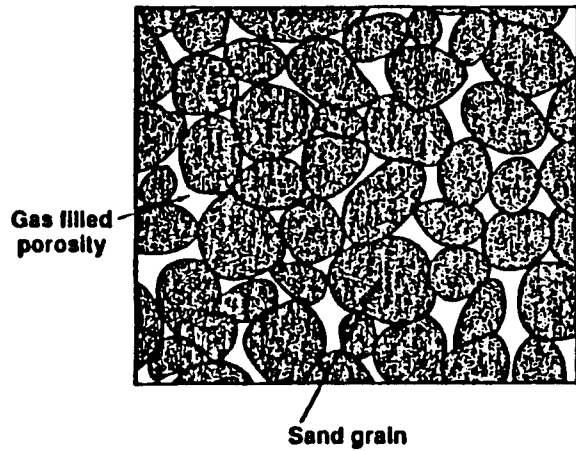

Absolute Permeability  
Generally  $< 0.1$  md for tight gas sands

Relative Permeability  
n/a

## Coalbed

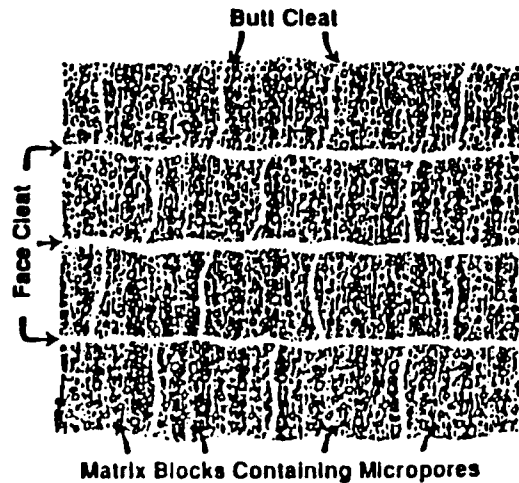

Absolute Permeability  
Varies from micro to  $> 100$  md

Relative Permeability

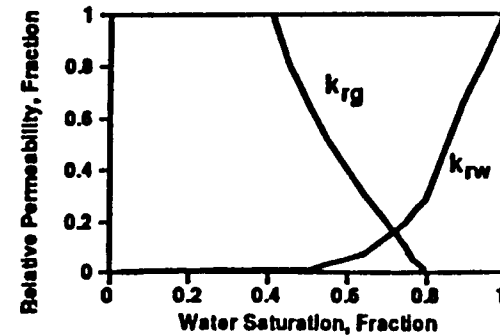

# GAS RECOVERY CONVENTIONAL VS. COALBED

**Conventional**

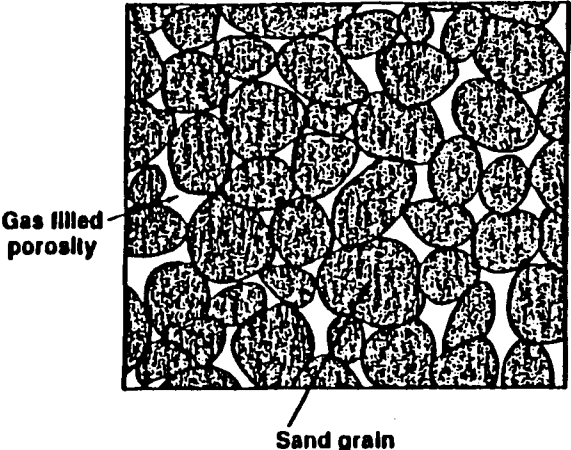

**Conventional**

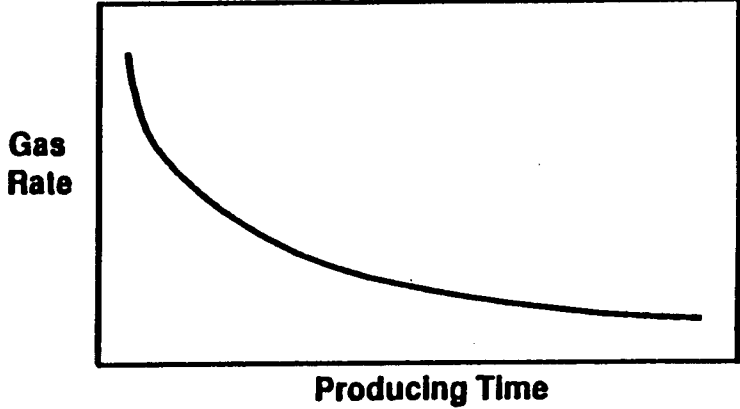

**Coalbed**

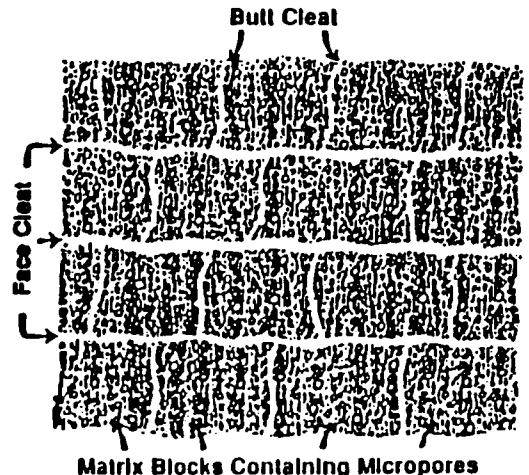

**Coalbed**

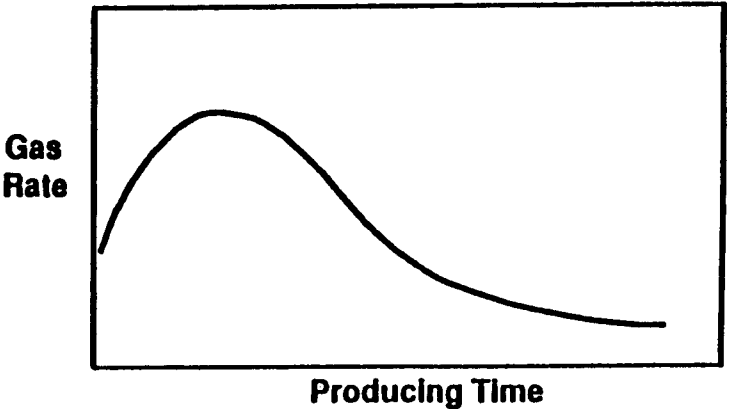

# GAS IN PLACE CONVENTIONAL VS. COALBED

## Conventional

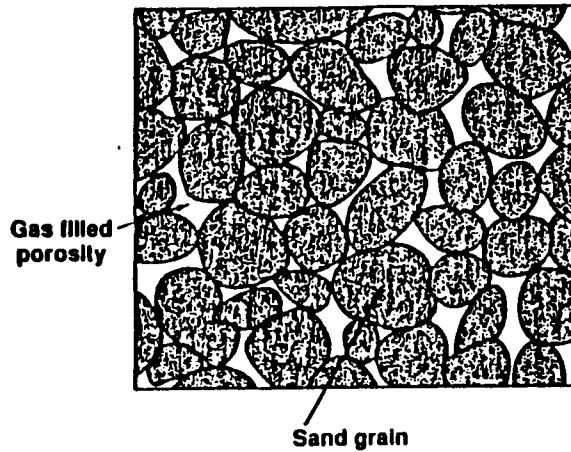

## Gas In Place

Function of P, T,  
Porosity, Gas  
Properties

\* 100% free gas

## Coalbed

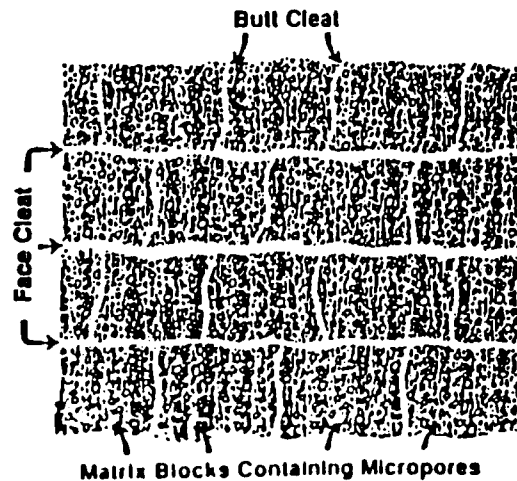

## Gas In Place

Adsorbed on Coal  
micropores; function  
of coal adsorptive  
capacity, P, T

\* No free gas

# WATER IN PLACE CONVENTIONAL VS. COALBED

## Conventional

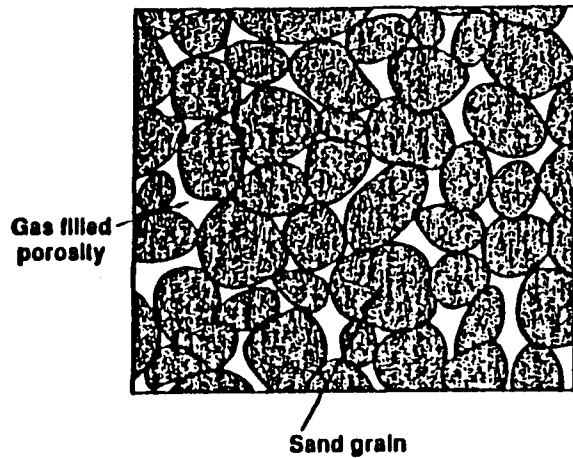

## Water In Place

None or not mobile

## Coalbed

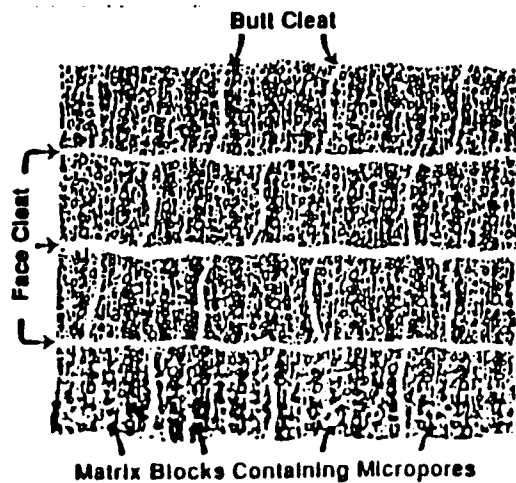

## Water In Place

Contained in cleat network. Cleats are generally 100% saturated at virgin conditions



## **CACULATION OF GAS IN-PLACE**

$$\text{GIP} = \text{GC} * \text{h} * \text{DA} * \text{p}$$

**Where:**

**GIP = Gas in-place/(cubic feet)**

**GC = Gas content/(cubic feet/ton)**

**h = Net coal thickness/(feet)**

**DA = Drillable area/(acres)**

**p = Coal density/(tons/acre-foot)**

## COALBED METHANE DATA CALENDAR YEAR 1980-1988

YEAR	PRODUCING WELLS	GAS PRODUCTION (MCF)	% OF WARRIOR BASIN PRODUCTION	% OF TOTAL STATE PRODUCTION
1980	3	4,613	0.02	0.004
1981	26	48,526	0.1	0.04
1982	73	1,623,575	3.8	1.2
1983	100	3,405,791	9.4	2.7
1984	184	6,428,950	14.5	4.7
1985	251	8,650,891	16.7	6.0
1986	324	13,065,868	24.0	8.9
1987	413	17,017,556	26.0	11.0
1988	512	19,867,725	28.4	11.2
	TOTAL	70,113,495		

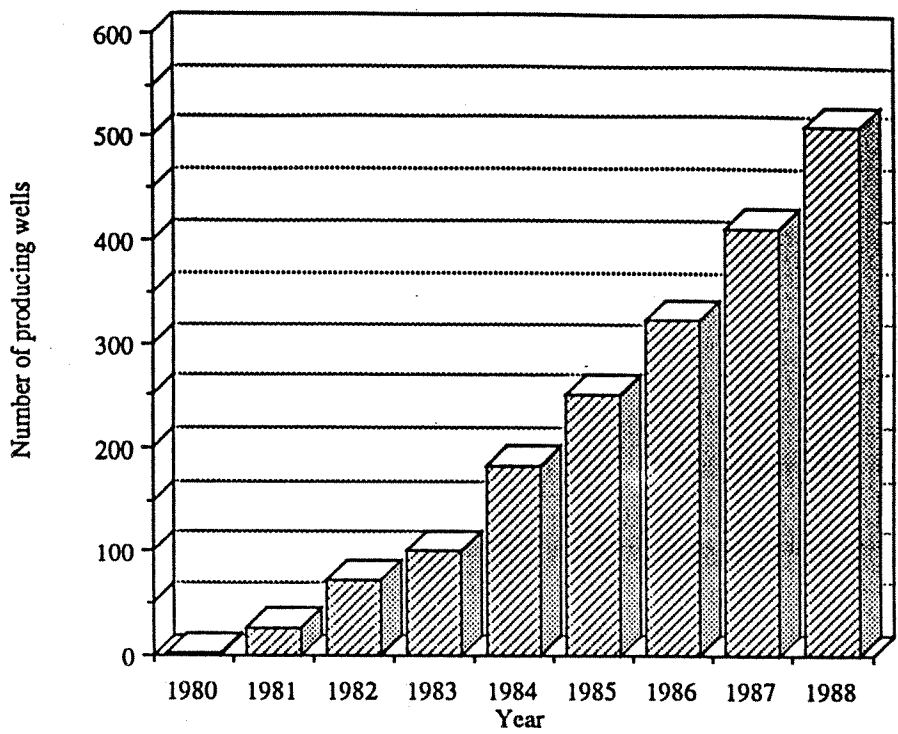

Figure 10. Producing coalbed methane wells in the Black Warrior basin, Alabama. (data courtesy of State Oil & Gas Board of Alabama)

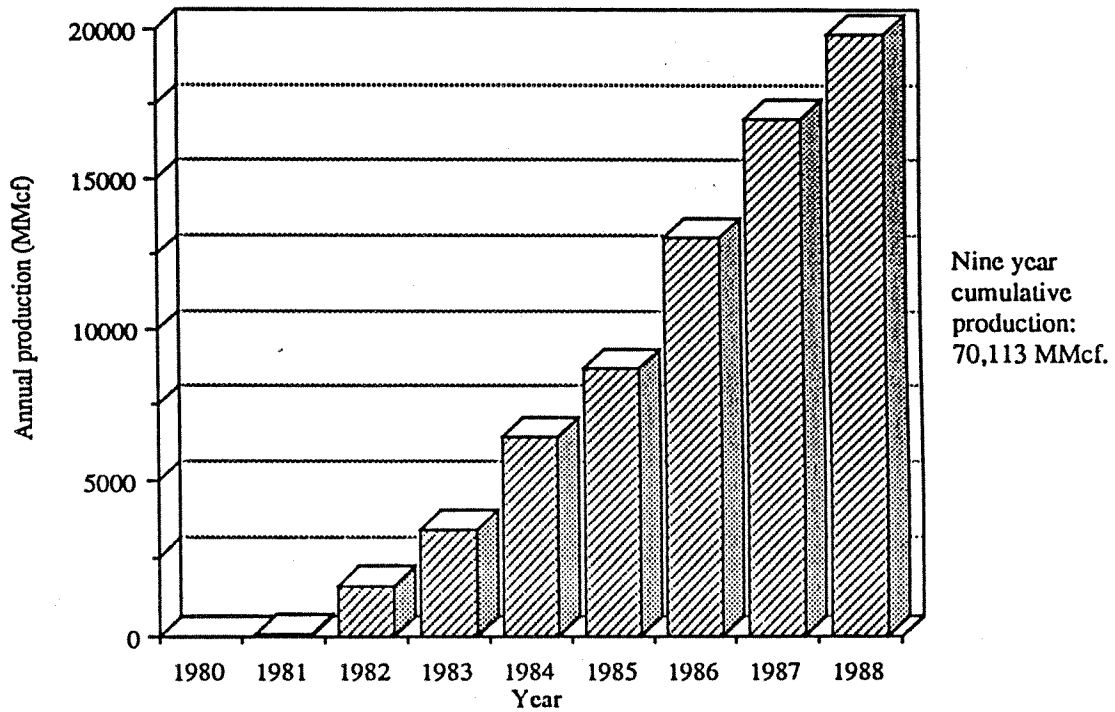
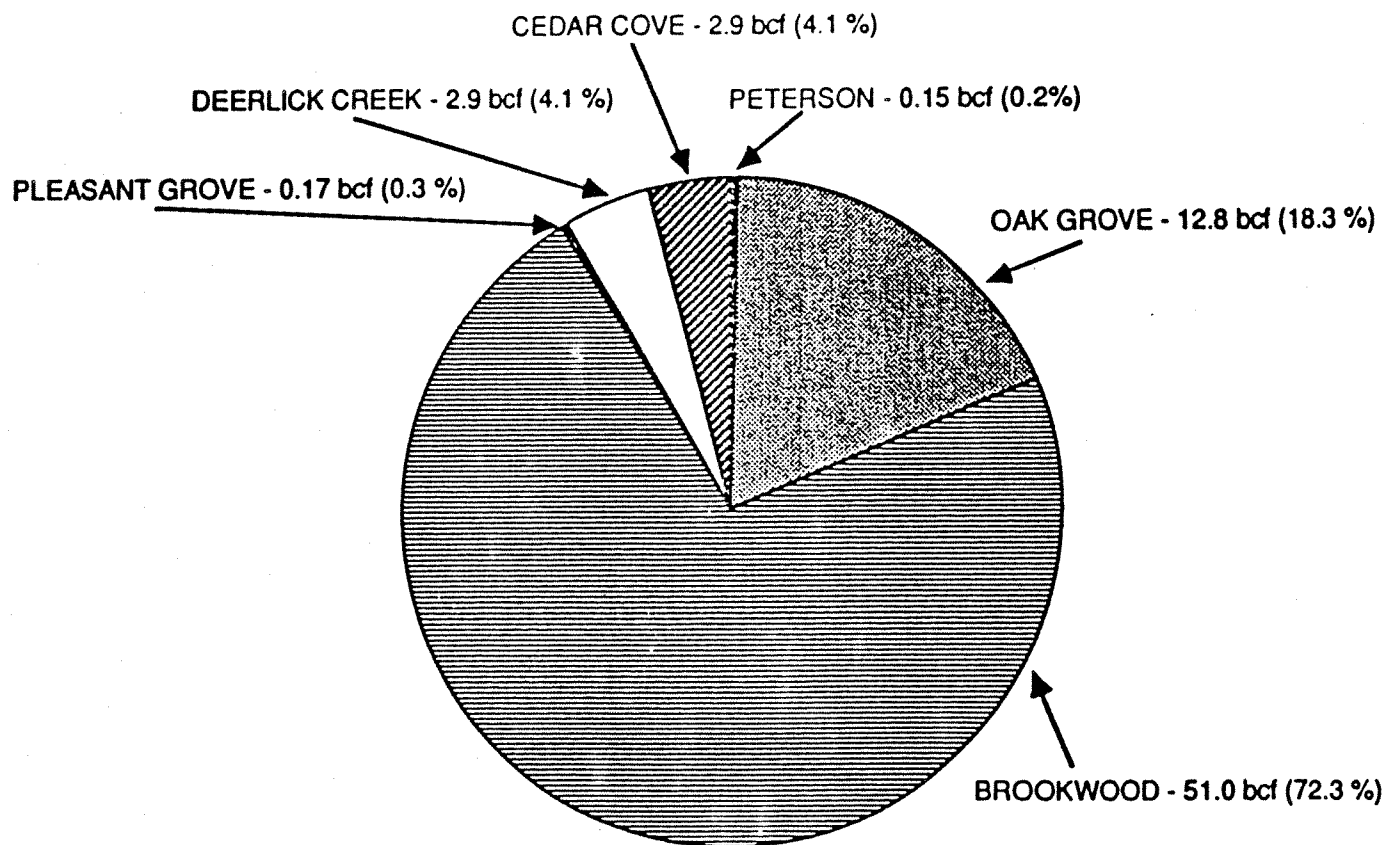

Figure 11. Annual production of coalbed methane in the Black Warrior basin, Alabama. (data courtesy of State Oil & Gas Board of Alabama)

# CUMULATIVE PRODUCTION BY FIELD



TOTAL CUMULATIVE PRODUCTION = 70.1 bcf

# Gas Recovery From Single Versus Multiple Seam Completion

**Current Technology**

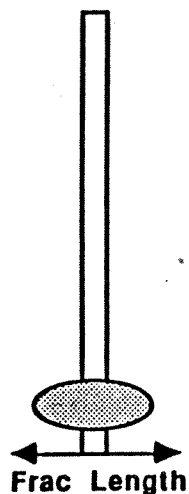

**Target Coal Groups**

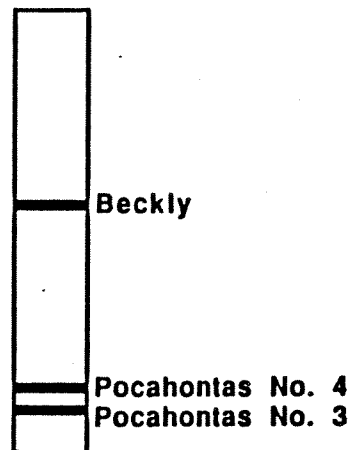

**Advanced Technology**

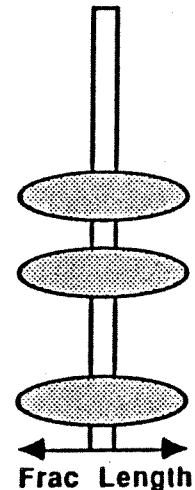

**Recovery per 640 Acre Section**

<u>Coal Group</u>	<u>Resource (Bcf)</u>	<u>Current Technology Gas Recovery (Bcf)</u>	<u>Advanced Technology Gas Recovery (Bcf)</u>
Beckly	1.4	-	0.7
Pocahontas No. 4	2.2	-	1.4
Pocahontas No. 3	<u>3.7</u>	<u>1.5</u>	<u>2.4</u>
<b>Total</b>	<b>7.3</b>	<b>1.5</b>	<b>4.5</b>

# Example of Negative Gas Production Decline Due to Dewatering - Warrior Basin

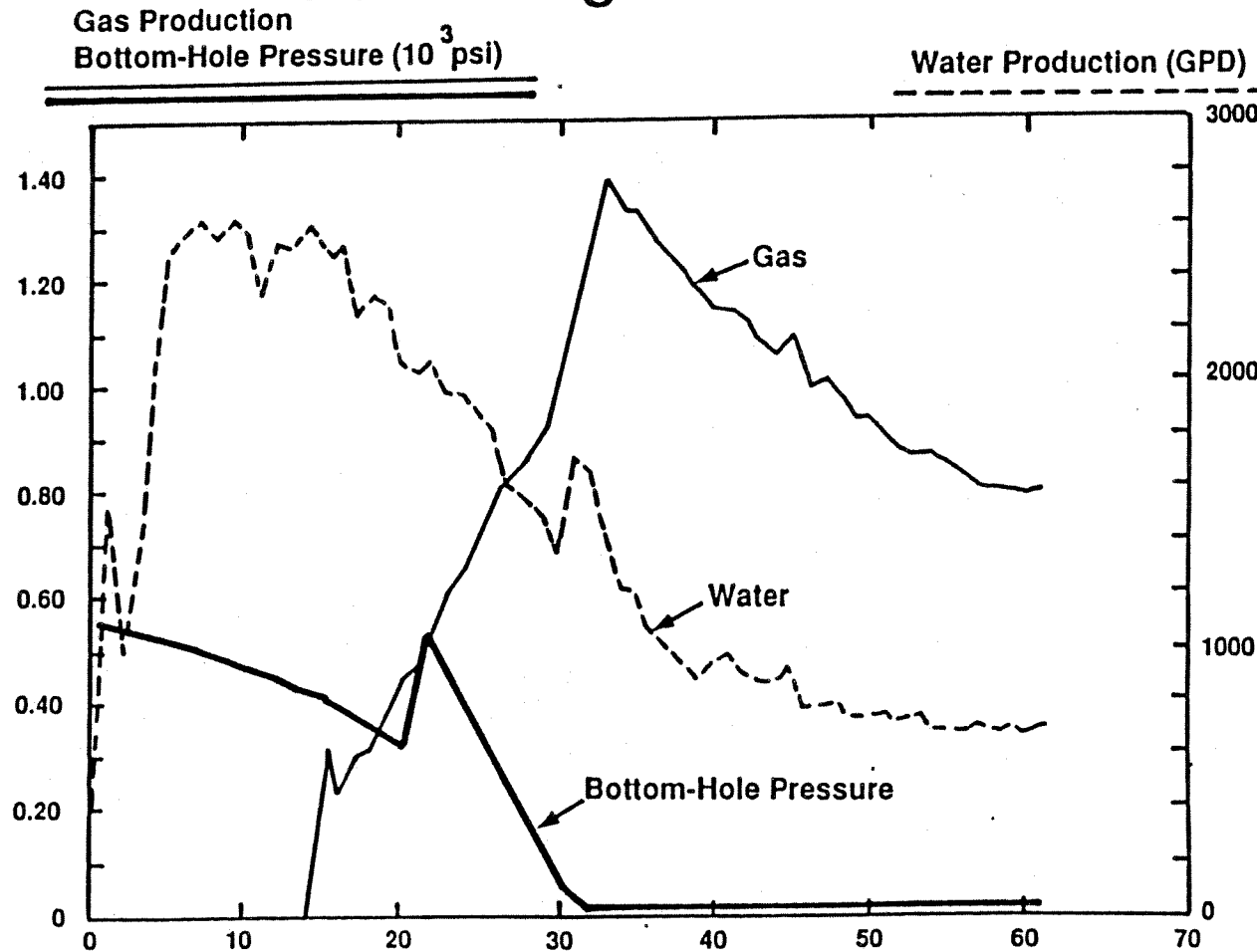

Daily gas and water production rates and bottom-hole pressure for production well P1C.

# LONG-TERM RECOVERY PREDICTION IS USED FOR RESERVE ESTIMATE

## OAK GROVE 23-WELL PATTERN

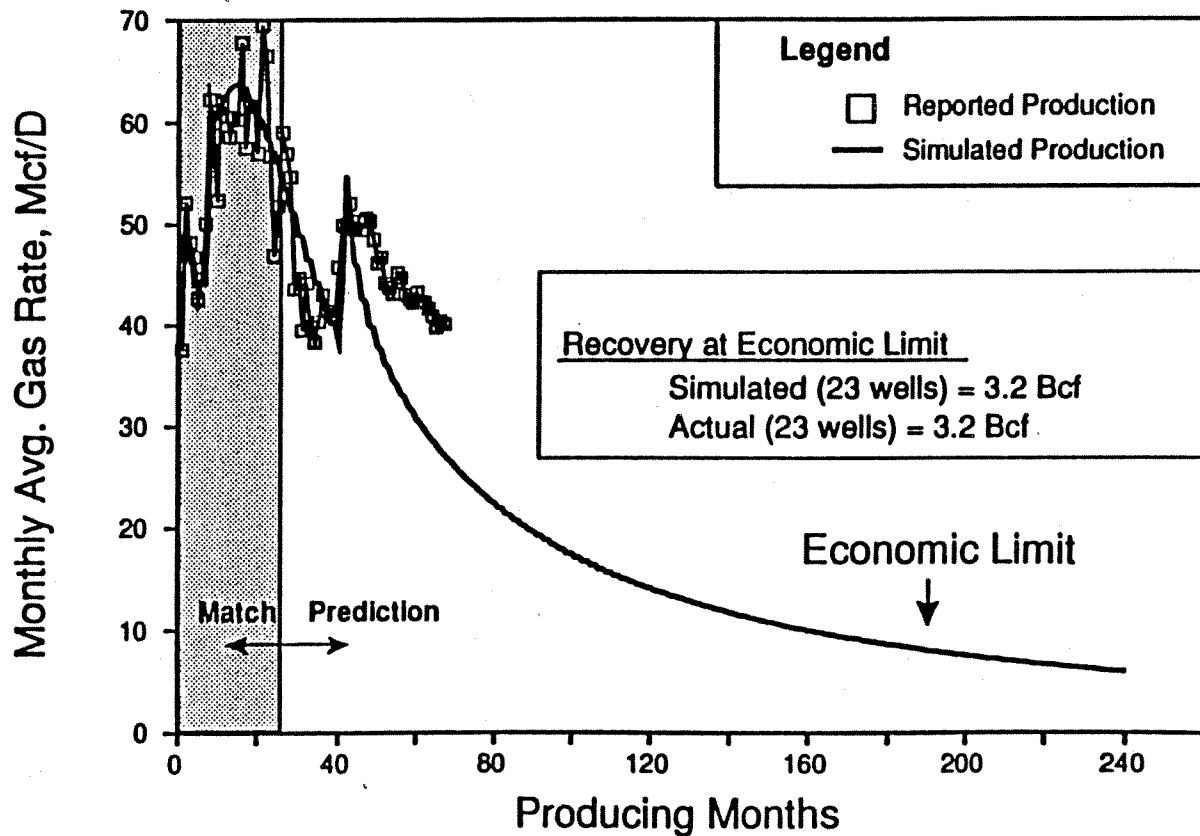

# PENNSYLVANIA ANTHRACITE FIELDS

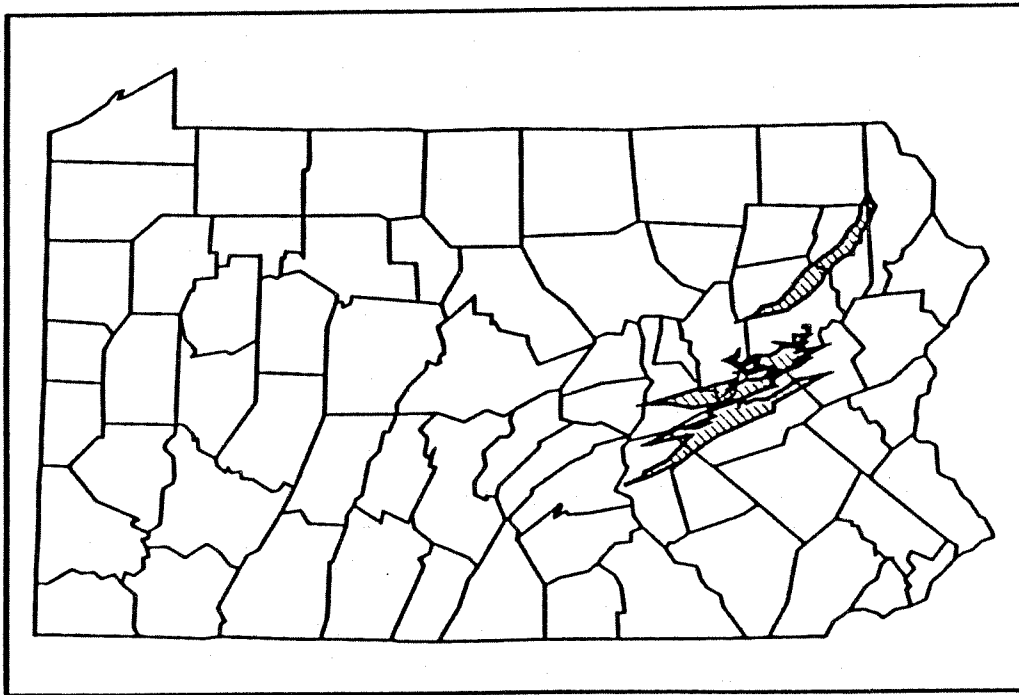

- Gas Content Up to 690 cf/t
- Structurally Complex
- Multiple, Thick Coal Seams



# NORTHERN APPALACHIAN BASIN

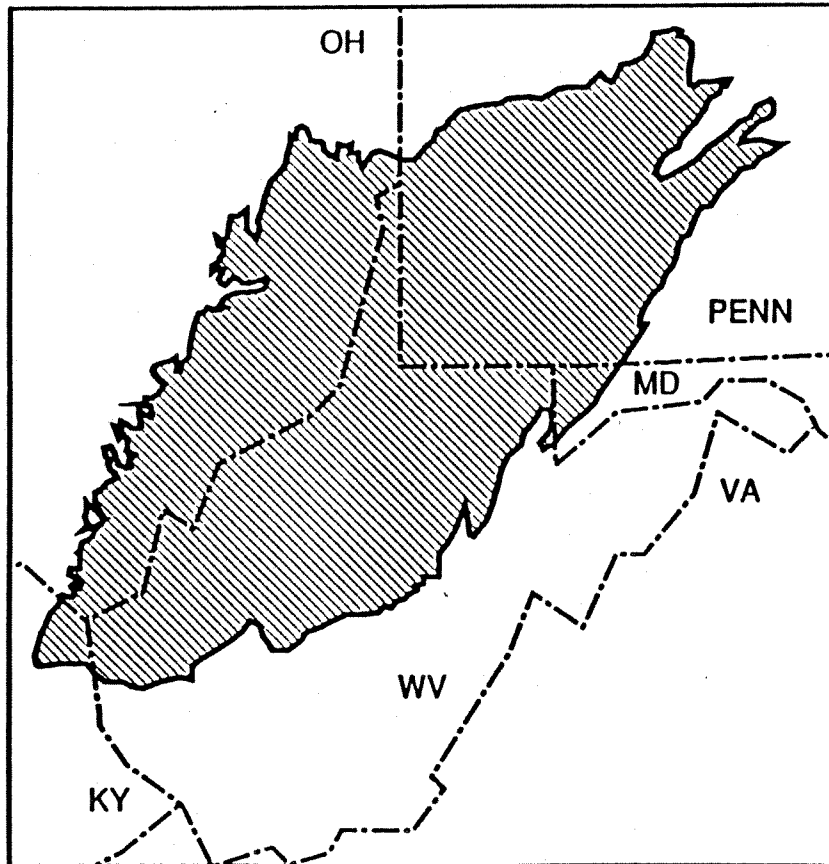

- 61 Tcf of Coalbed Methane Resource
- Six Principal Target Seams
- Potential for Multiple Completions
- Area of Highest Methane Concentration in SW PA and NW WV

# CENTRAL APPLACHIAN BASIN

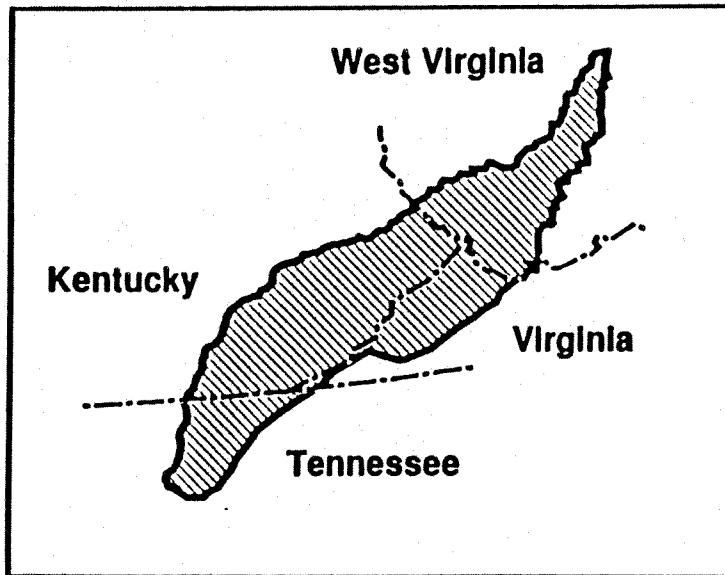

- **5 Tcf of Coalbed Methane Resource**
- **Six Principal Target Seams**
- **Potential for Multiple Completions**
- **High Quality, Concentrated Resource In SW VA and SE WV**

# ARKOMA BASIN

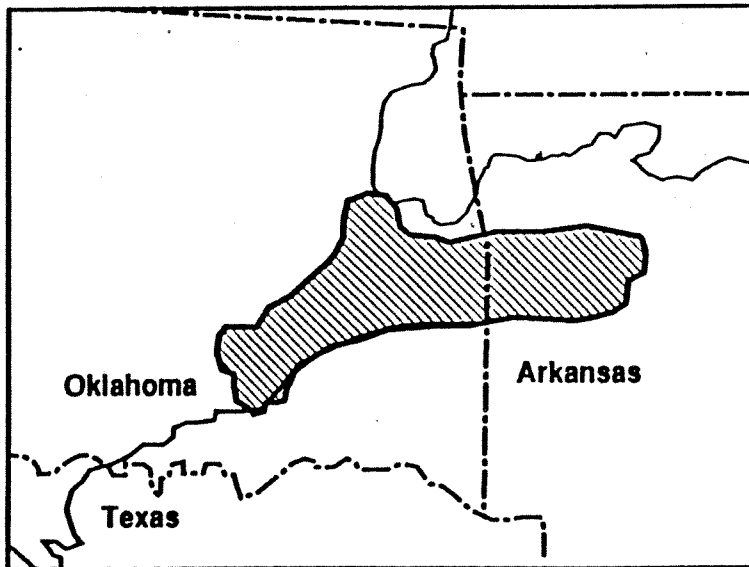

- DOE Estimates 4 Tcf of Coalbed Methane Resource
- Hartshorne Coal has High Gas Contents (Up to 700 cf/t)
- Established Oil and Gas Infrastructure
- Permeability and Other Reservoir Parameters Unknown

# GREATER GREEN RIVER AREA

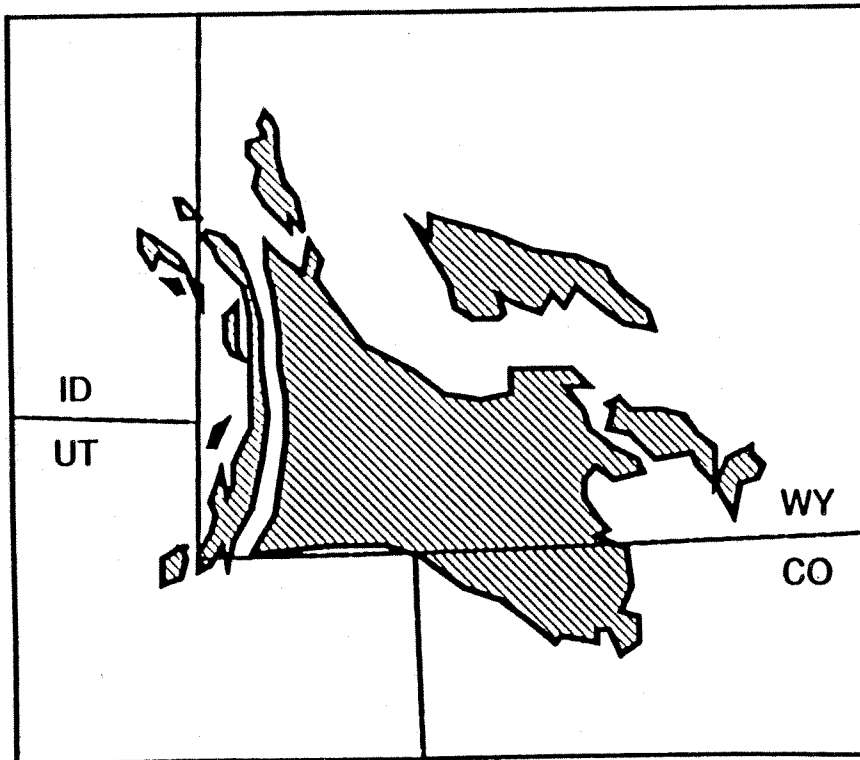

- DOE estimates between 0.2 and 30 Tcf of gas in place
- Numerous seams averaging 5-10 feet thick
- Gas contents of over 500 cf/ton
- Area of active exploration

# RATON BASIN

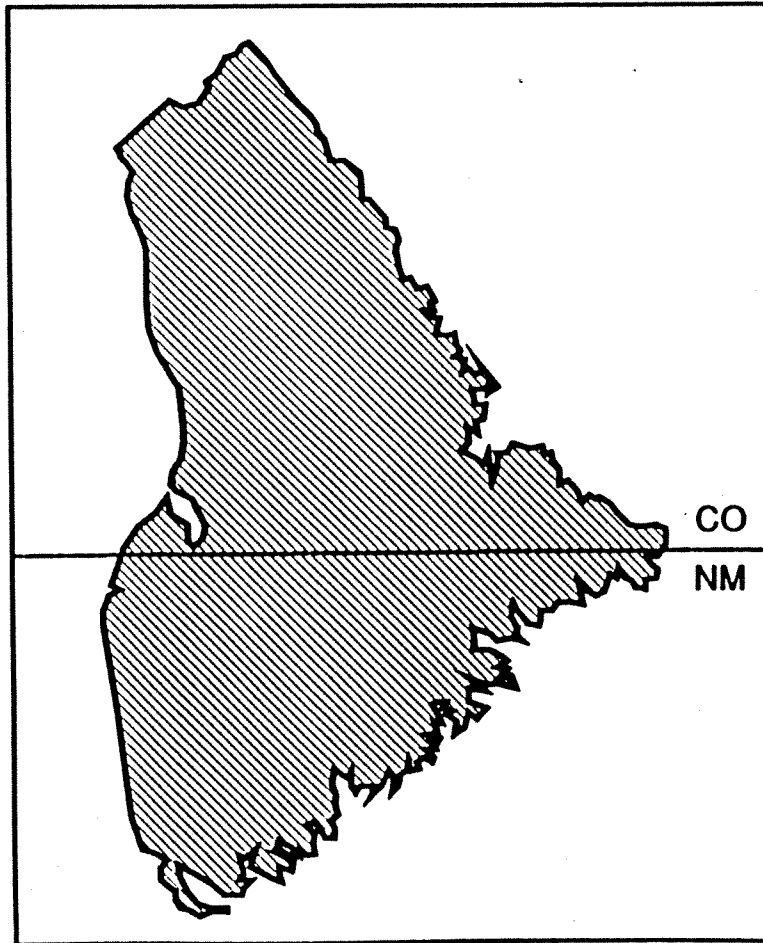

- DOE estimates between 8.0 to 18.4 Tcf of coalbed methane in place
- Gas contents in excess of 500 cf/ton
- Higher rank coal is associated with local igneous intrusions

# UINTA BASIN

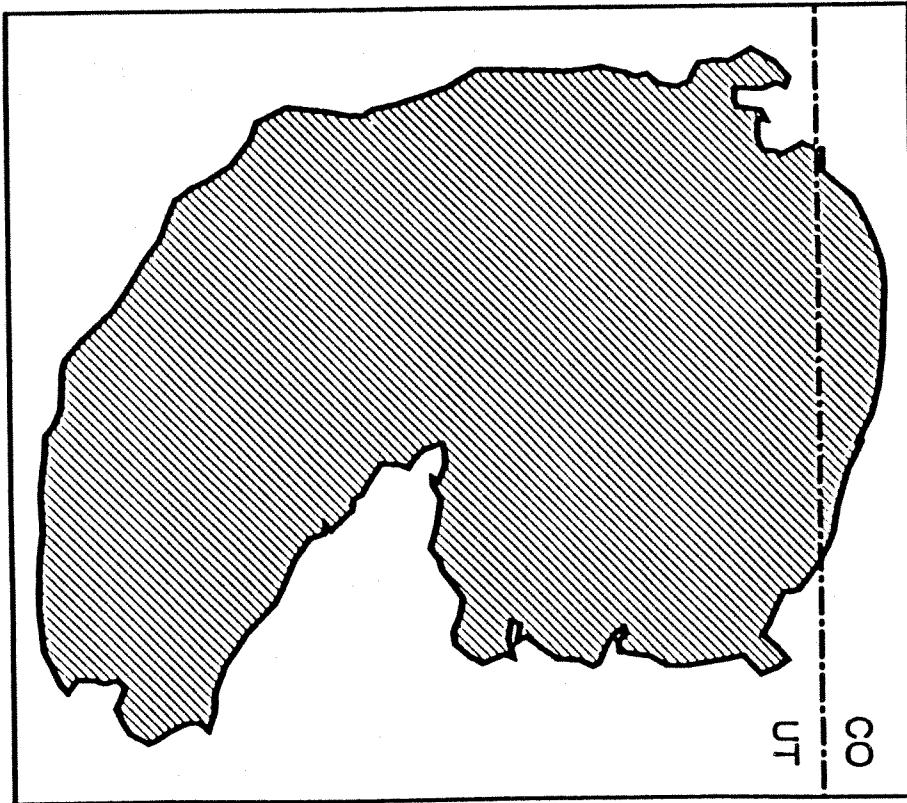

- 0.8 to 4.6 Tcf of gas in place
- Two primary coal zones; individual seams 1-20 feet thick
- Gas contents up to 350 cf/ton

# PICEANCE BASIN

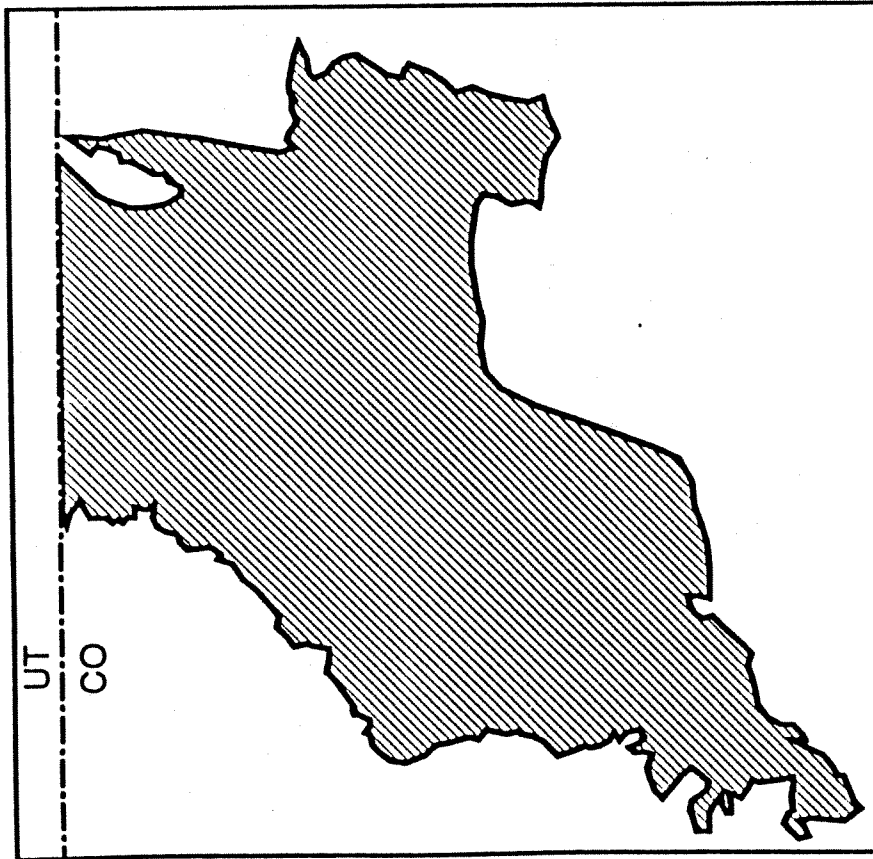

- 84 Tcf of gas in place
- Three major coal groups
- Gas contents over 400 cf/ton
- Higher rank coal beds in the east-central portion of the basin have the most potential

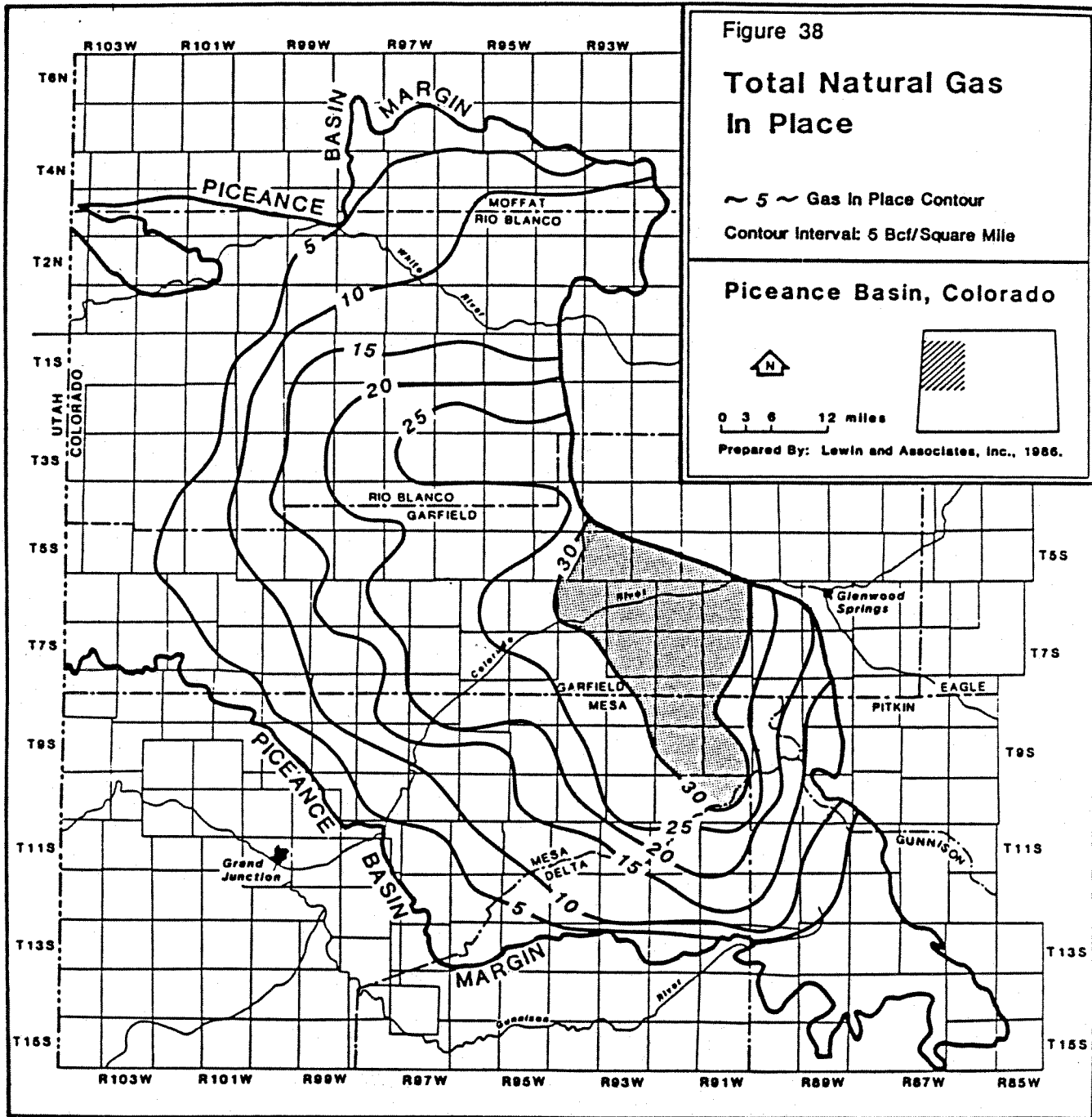







Lewin & Assoc, 1987





Figure 25

### Coal Rank Map— Cameo Group

-  Semi-Anthracite
-  Low Volatile Bituminous
-  Medium Volatile Bituminous
-  High Volatile A Bituminous
-  High Volatile B Bituminous
-  High Volatile C Bituminous

### Piceance Basin, Colorado

 N



Prepared By: Lewin and Associates, Inc., 1986.  
Modified from Nuccio & Johnson, 1983.

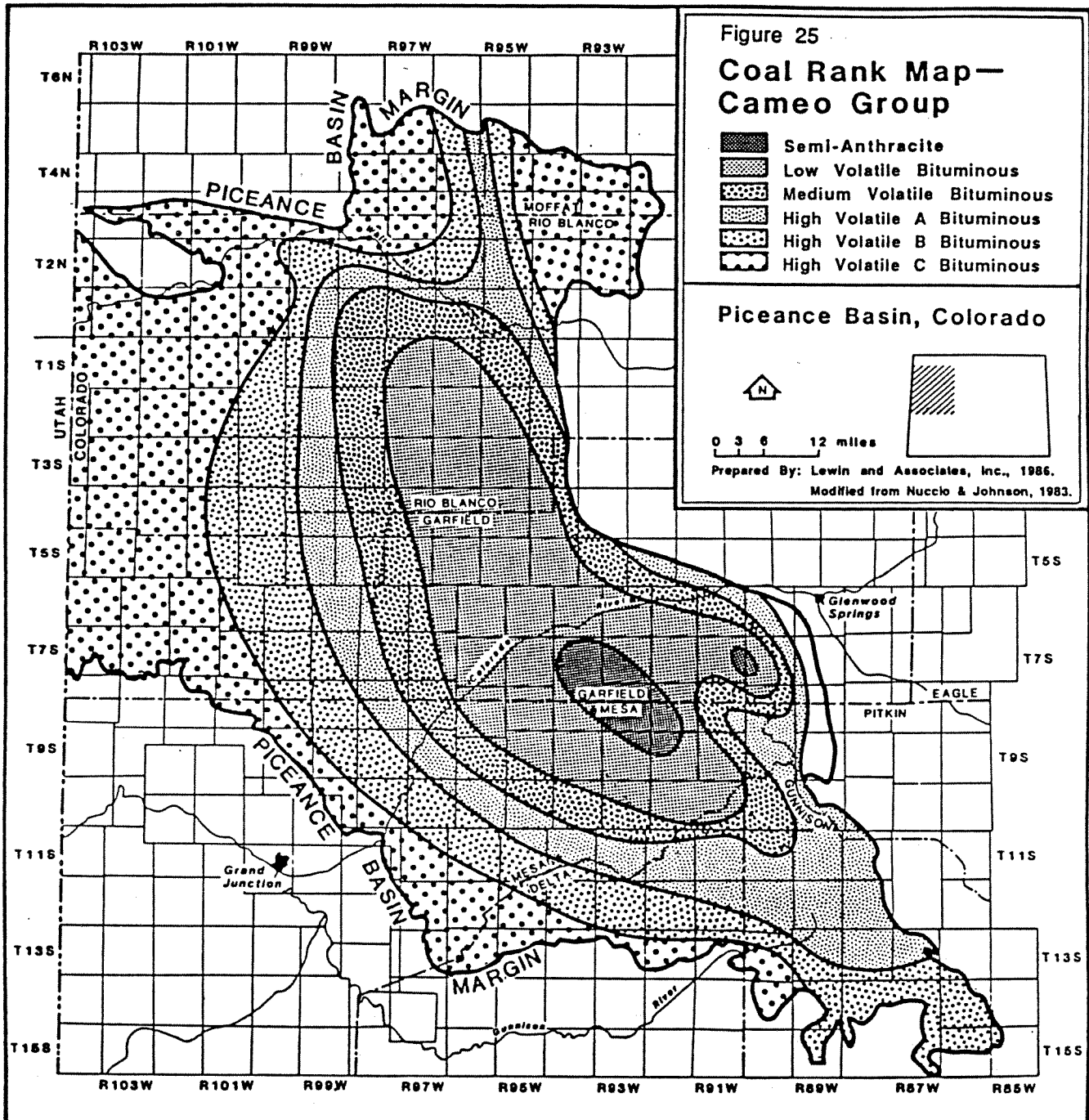

Lewin & Assoc, 1987

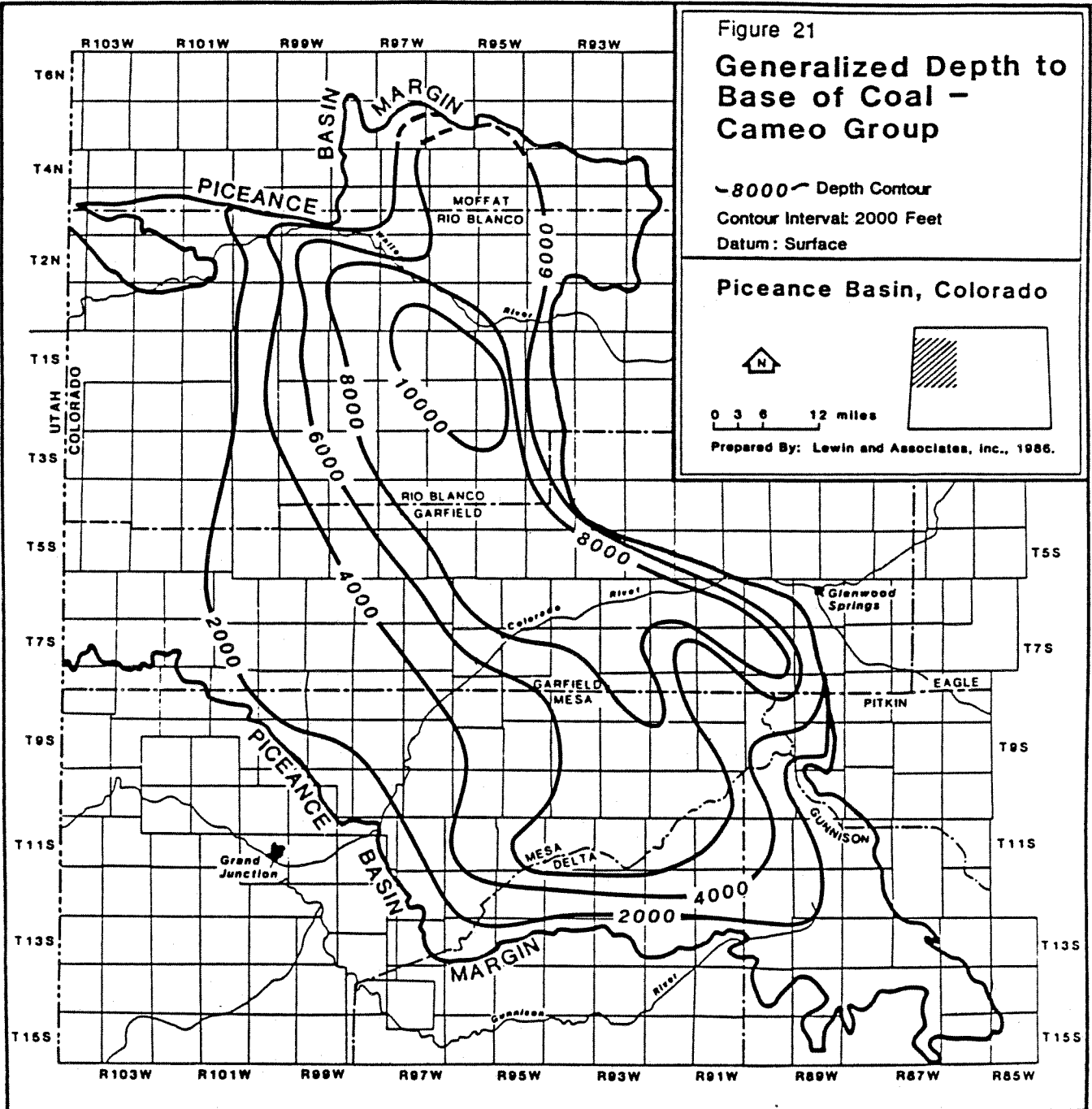

Lewin & Assoc., 1987

# WESTERN WASHINGTON COAL REGION

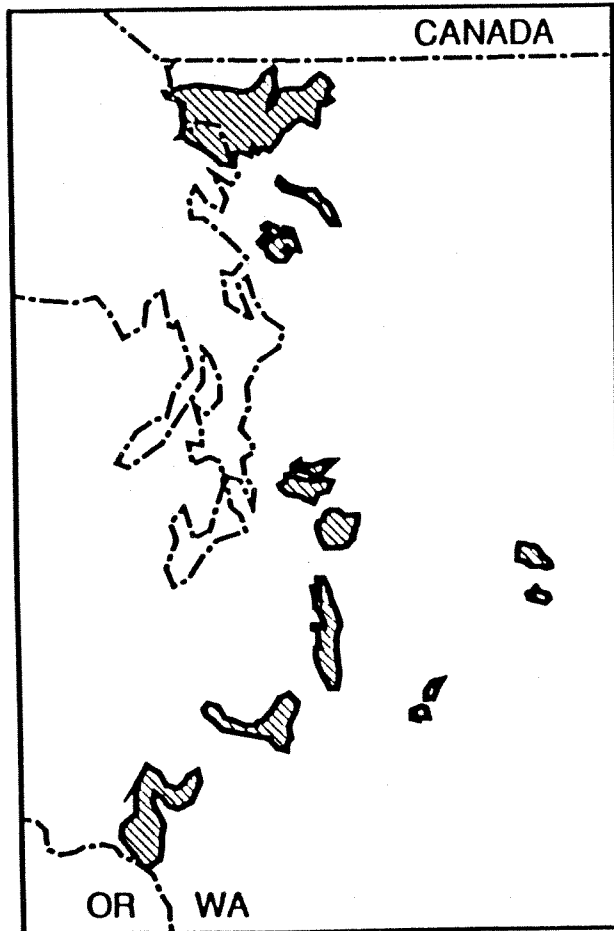

- DOE estimates 0.3 to 24 Tcf of gas in place
- Several thick seams, up to 15 feet; average 2-5 feet
- Potential for multiple completions
- Area of highest potential in NW part of state

# TERTIARY COAL BASINS of the PACIFIC NORTHWEST

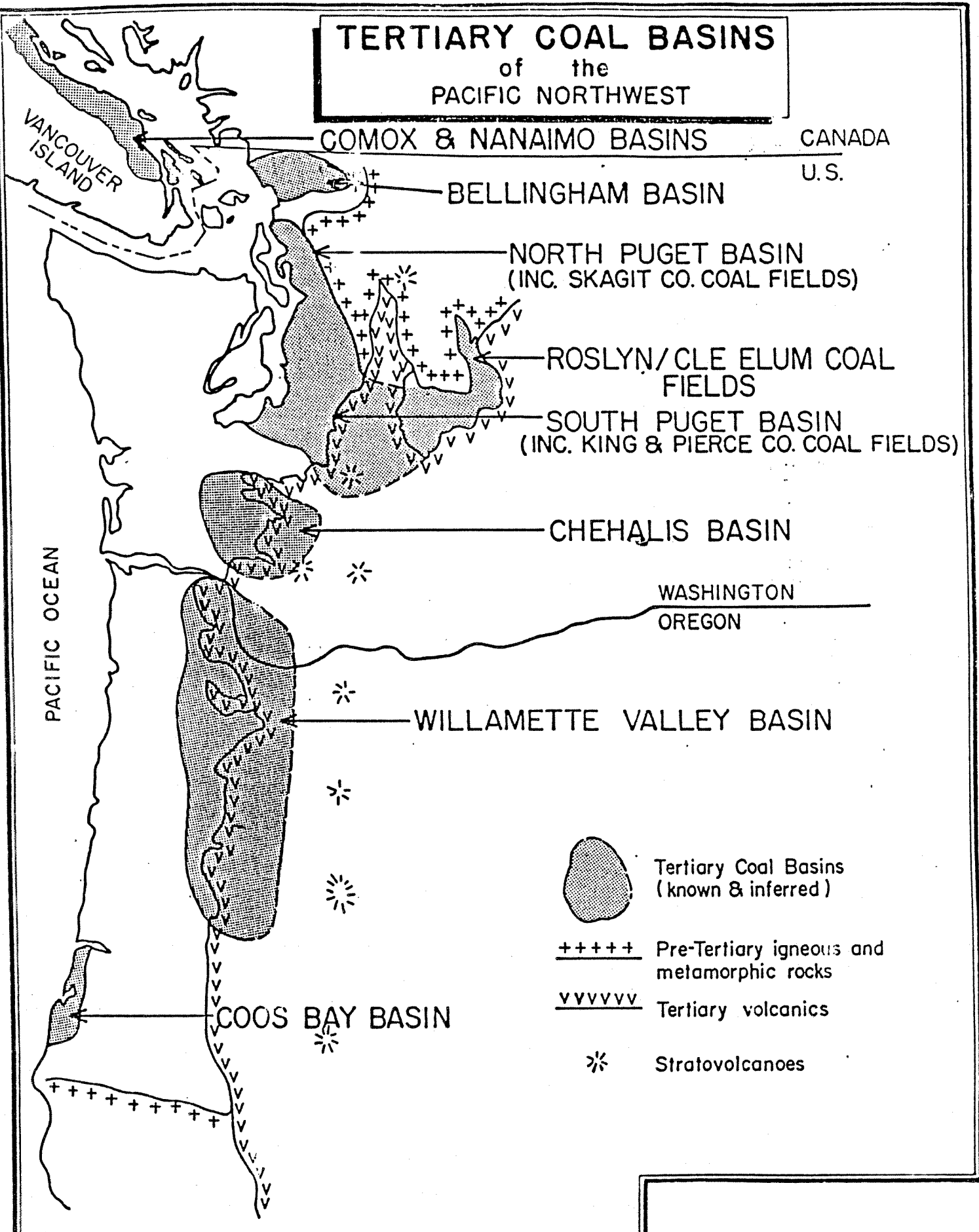

COMOX & NANAIMO BASINS

CANADA

U.S.

BELLINGHAM BASIN

NORTH PUGET BASIN  
(INC. SKAGIT CO. COAL FIELDS)

ROSLYN/CLE ELUM COAL FIELDS

SOUTH PUGET BASIN  
(INC. KING & PIERCE CO. COAL FIELDS)

CHEHALIS BASIN

WASHINGTON  
OREGON

WILLAMETTE VALLEY BASIN

COOS BAY BASIN

 Tertiary Coal Basins  
(known & inferred)

+++++ Pre-Tertiary igneous and  
metamorphic rocks

vvvvvv Tertiary volcanics

 Stratovolcanoes

SCALE : 1 inch = 62.5 miles

STAN GRAVES

DEVELOPMENT IN THE WARRIOR BASIN OF ALABAMA

A

SLIDE PRESENTATION

# Development of the Black Warrior Coal Basin in Alabama

## U.S. Basins With Coalbed Methane

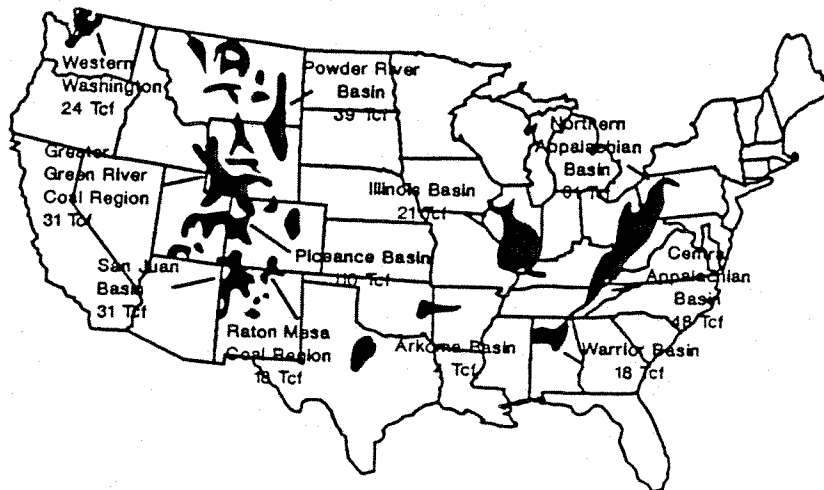

SOURCE: Journal of Petroleum Technology, February 1989

# Alabama's Black Warrior Basin

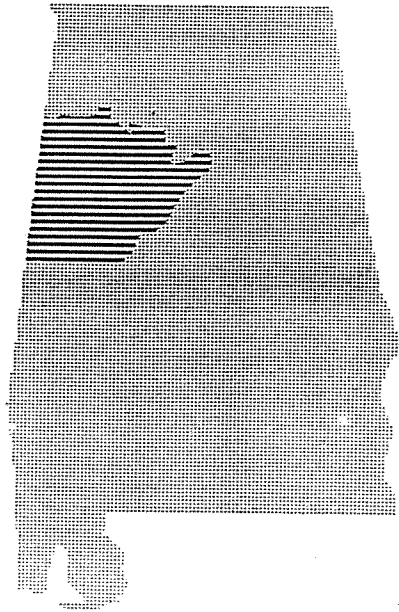

# Degasification Fields

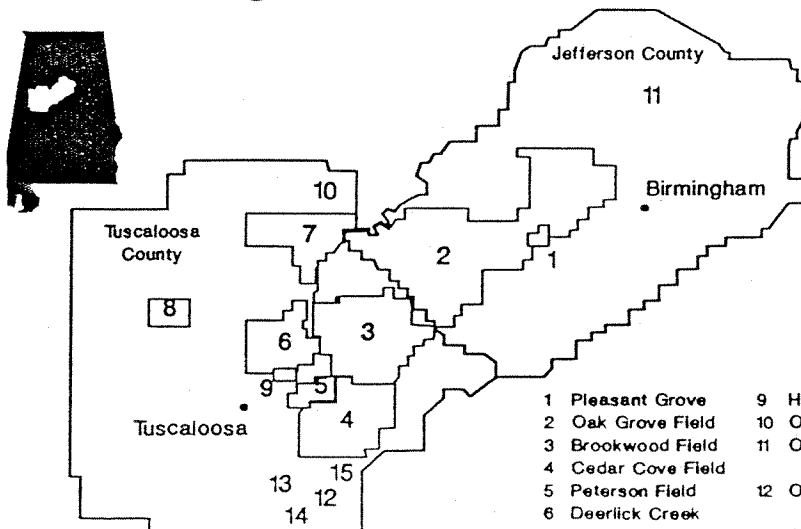

- |                    |  |
|--------------------|--|
| 1 Pleasant Grove   | 9 Holt                                     |
| 2 Oak Grove Field  | 10 Op: Amoco Production                    |
| 3 Brookwood Field  | 11 Op: Guernsey Petroleum/<br>Lasseter Op. |
| 4 Cedar Cove Field | 12 Op: Pruet Production/<br>Lasseter Op.   |
| 5 Peterson Field   | 13 Op: McKenzie Methane                    |
| 6 Deerlick Creek   | 14 Op: Marsh Operating Co.                 |
| 7 Blue Creek       | 15 Op: McCormick Resources                 |
| 8 Carrolls Creek   |  |

# **Degasification in Advance of Mining**



Center Well



Stimulated





## **1971**

- Bureau of Mines and U.S. Steel
- 5-well pilot program
- Degasification successful

## **1975**

- Expanded pilot program
- 20 wells
- Consistent results from stimulation
- No roof damage

## 1978

- AMPCO
- Abandoned

## 1979

- National Exploration and Intercomp
- 2 wells
- Multiple-seam completion
- Abandoned

## **1979**

- Jim Walter Corp. and Intercomp
- Gob, horizontal and vertical
- Degasification necessary

## **1980-83**

- AMPCO
- 5 wells
- Multiple-seam completion  
successful

## 1980

- APPA and DOE
- Municipal gas supply
- Pleasant Grove
- Marginally successful

## 1980

- Tuscoal Project
  - Intercomp
  - Texas Energy Service
  - Texas Eastern
  - Sun Gas
- Abandoned

**1981**

- **APGA and Cullman-Jefferson Gas District project**
- **Abandoned**

**1981**

- **University of Alabama and AGPA**
- **Faulting and water problems**
- **Low production**
- **Abandoned 1987**

## **1982**

- TRW
- Production in 1982
- Sales in 1984
- 31 wells

## **1982**

- Coaltech
- First commercial sale from multiple seam completion

## **1983**

- Brookwood Oil and Gas
- Drilled 4 wells
- Never produced
- Abandoned

## **1983**

- 4-J Exploration
- Drilled 14 wells
- Developed pipeline
- Not operational

## **1984**

- Gas Research Institute
- Research project
- Multiple-seam completion
- Develop methods to measure gas content, permeability and producibility
- Technology transfer

## **1985**

- Methane Drainage Ventures and USX
- Horizontal wells



## 1986

- Taurus Exploration
- Aggressive drilling program

## 1987

- TXO and U.S. Steel Mining
- Gob wells

## **1986 - 89**

- Extensive growth
- 1986 = 5 operators
- 1989 = 22 developers

**Current Status  
of  
Development in  
Black Warrior Coal Basin**

## **New Operators**

American Methane	Marsh Operating
ARCO	McKenzie Methane
Chevron	Meridian Oil
GLG Energy	MetFuel
Guernsey Petroleum	Phillips
Hurricane Creek Operating	Pruet Production
IP Petroleum	Torch Energy
Jenco	Victory Resources
Lasseter Operating	

## **1989 Consolidations**

- Amoco Production
  - Alabama Methane
  - Black Warrior Methane
  - DeGas
  - City of Pleasant Grove
  - River Gas
  - USS Mining
  - Taurus Exploration
- 

## Annual Wells Permitted

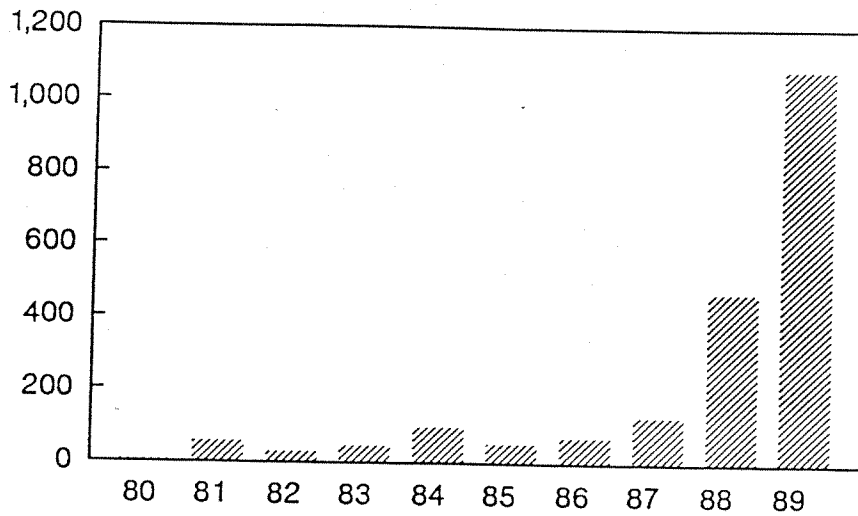

## Cumulative Production (MMcf)

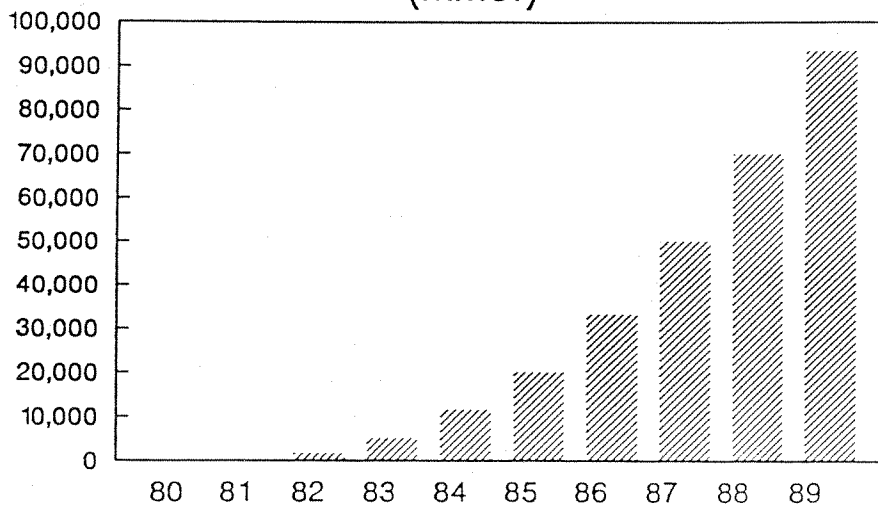

## April 1990

- River Gas: 350 wells in 1990
- Taurus: new project with Chevron and TECO
- Torch Energy: 300 wells/\$100 MM
- Magnolia Pipeline

## Alabama's Coal Basins

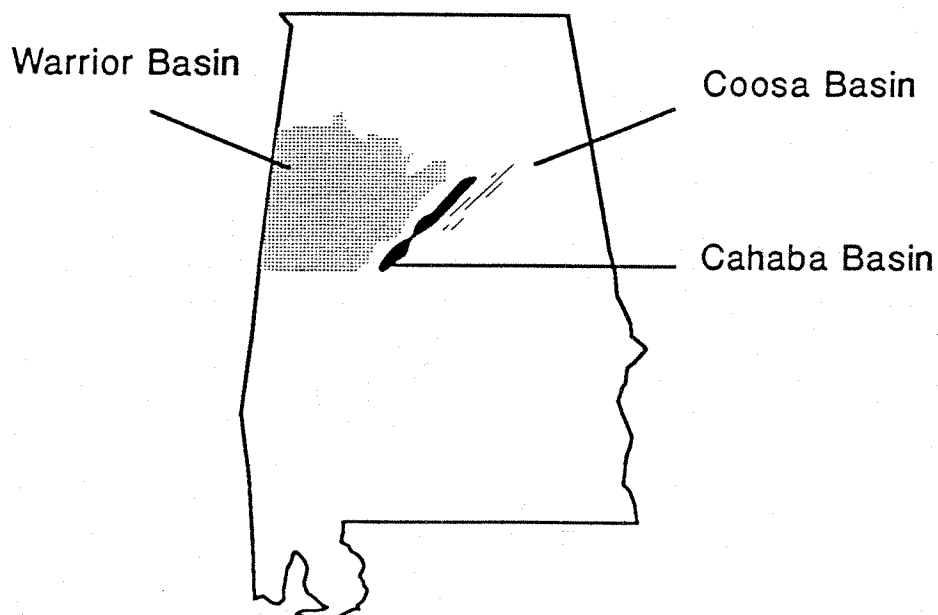

- Acreage acquisition
- Environmental opposition
- Regulatory pressure

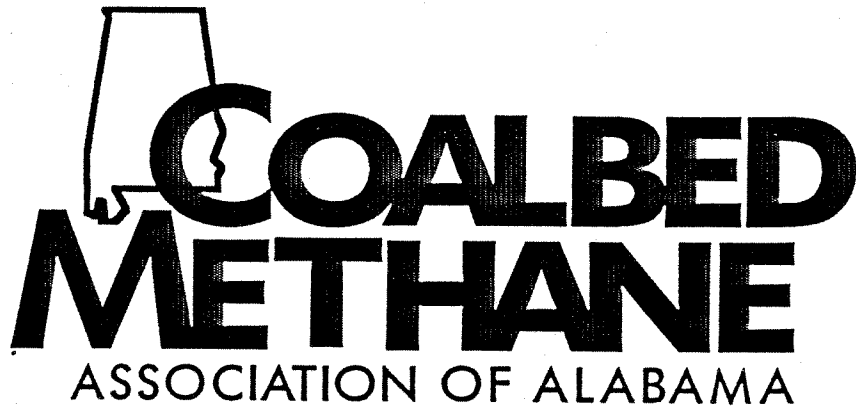

**Negative Publicity**  
**Misinformation**



# Public Relations Committee

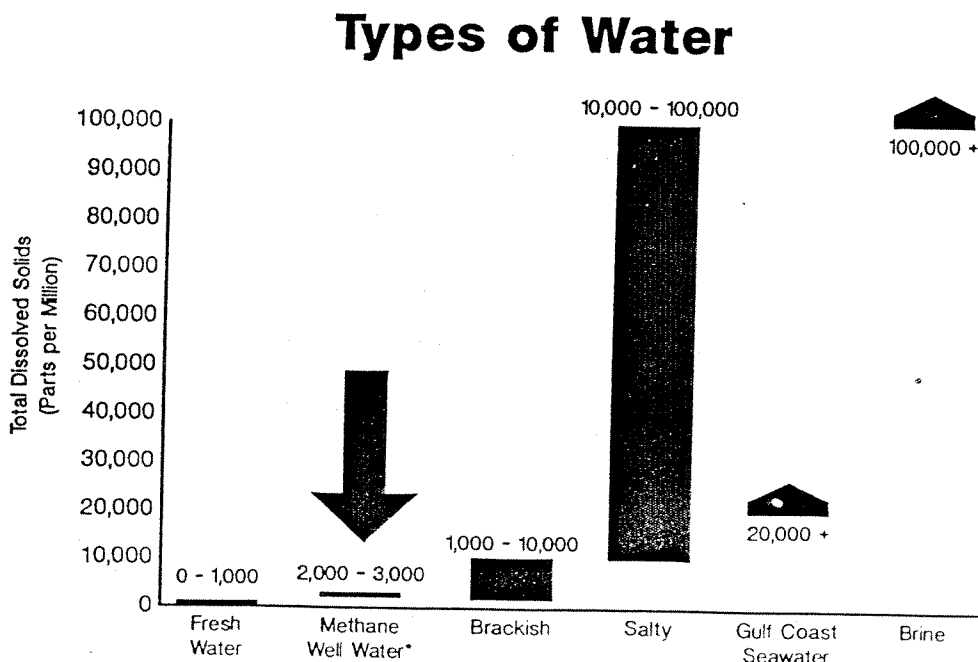

\* Typical produced water from methane well in Black Warrior coal field

# **Focus**

- **Media**
- **Business**
- **Environmentalists**
- **Government**

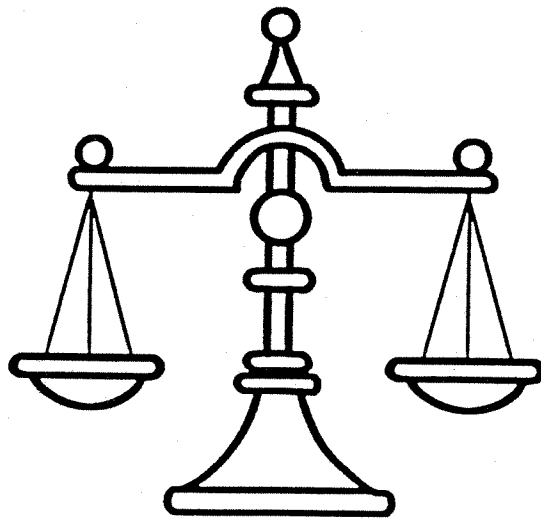

**LEAF vs. River Gas**

## **EPA Position**

- **40CFR435 excludes coalbed methane**
- **Comparable to underground mining**
- **Consistent discharge limits**

## **CMAA Position**

- **Critical to development**
- **"Friend of Court"**

## **CMAA Modifications**

- Dues structure revised
- Board of directors enlarged
- Executive director hired

## **Ruling**

- **Dismissed: Lacked legal standing**
- Adequate remedies exist
- LEAF appealed
- LEAF filed suit regarding frac fluids

## **Reevaluation of Permitting Strategy**

- **Restricts growth**
- **1988 instream chloride criteria**
- **Maximum 230 m/l**
- **More than adequate protection**
- **Acute < 1,500 m/l**  
**Chronic 565 m/l range**



- **Assist ADEM in developing new strategy**
- **Develop real-time instream monitoring system**

## **Phase I**

- **Preliminary feasibility study**
- **\$35,000**
- **CMAA funded**
- **ADEM involved**
- **Completed September 1989**

## **Phase II**

- **Engineering design**
- **\$35,000**
- **Funded by ADECA and industry**
- **Completed October 1989**

## **Phase III**

- **Installation of equipment and operations**
- **\$200,000**
- **Funded by industry**
- **Operations begin June 1990**

# January 1990

Members agreed to form and fund

- Corporate structure
- 2-year commitment
- Prorate cost
- New members added and cost reduced for existing members

## 10 Charter Members

- Amoco
- Atlas
- Chevron
- Lassiter
- McKinsey
- Meridian
- Pruitt
- River Gas
- Taurus
- Torch



# Modifications

- Retain original discharge position
- Establish subordination for future permits

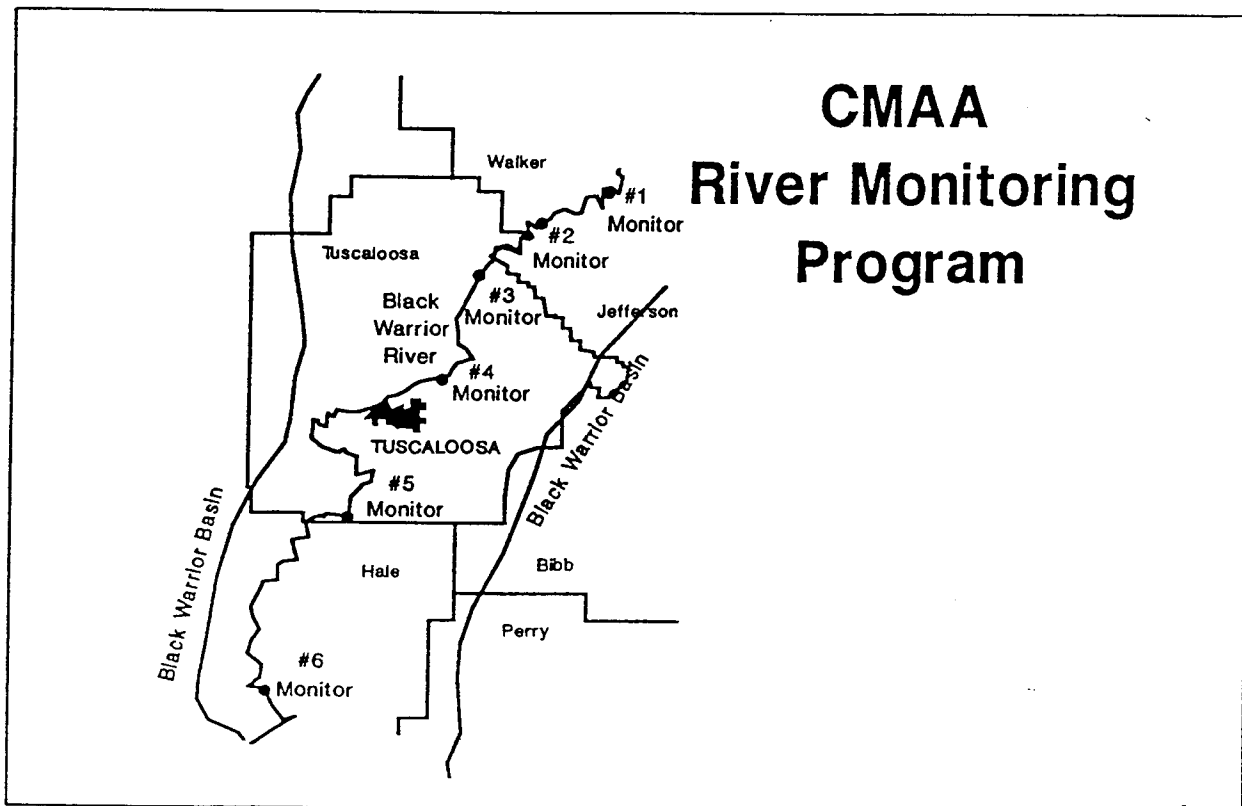

## **Teir II**

When instream concentration reaches

- 190 MG/L: Alert sent to Teir II permittees
- 210 MG/L: Stop discharge until decreases to 190 MG/L

## **CMAA's Future**

- Legislation
  - Shelby County permit fees
  - Fire district fees
  - Well bonds
  - Extension of Section 29 Tax Credit
  - BMP for nonpoint source runoff
- Instream monitoring program
- New bioassay study
- Vital to future development

# **What's Needed for Development of a New Basin?**

- 1. Define resource**

## 2. Establish regulatory protocol

### **OGB Regulations**

- Well construction
- Spacing
- Field rules
- Pit construction
- Operating practices
- Operating reports

# **OGB Regulations**

- Bonded: \$5,000 each or \$100,000 blanket
- Plat
- Notification before
  - Spudding
  - Logging
  - Cementing
  - Stimulating
  - Producing
  - Perforating

# **ADEM**

- Land application
- Instream discharge
- Rule making authority questioned by LEAF

# **Cahaba River Society**

Outstanding Natural  
Resource Water  
rulemaking petition

**3. Educate financial/  
investment community**

## Coalbed Methane Econometric Model

San Juan: Plain Vanilla

	10%	15%	Promoted 15%
Reserves (MMcf) (320-acre unit)	3,236	2,573	2,573
Well cost (000)	\$629	\$629	\$723
Cost/Mcf	\$0.19	\$0.24	\$0.28
Economic life years	25+	23	23

SOURCE: Ammonite Resources

## Coalbed Methane Econometric Model

San Juan: Sweet Spot

	6.5%	15%
Reserves (MMcf) (320-acre unit)	9,049	5,568
Well cost (000)	\$729	\$729
Cost/Mcf	\$0.08	\$0.13
Economic life years	25+	25+

SOURCE: Ammonite Resources

## Internal Rate of Return

After Tax With Section 29 Tax Credit

San Juan	<u>%</u>
Sweet Spot (6.5%)	99
Sweet Spot (15%)	98
Plain Vanilla (10%)	53
Plain Vanilla (15%)	52
Plain Vanilla (15% promoted)	43

SOURCE: Ammonite Resources



# **Coalbed Methane Econometric Model**

Black Warrior: Average Well

	<u>15%</u>	<u>Promoted 15%</u>
Reserves (MMcf) (80-acre unit)	515	515
Well cost (000)	\$325	\$374
Cost/Mcf	\$0.63	\$0.73
Economic life years	24	24

SOURCE: Ammonite Resources

## Coalbed Methane Econometric Model

Black Warrior: Good Well

	6.5%	15%	Promoted 15%
Reserves (MMcf) (80-acre unit)	1,155	755	755
Well cost (000)	\$325	\$325	\$374
Cost/Mcf	\$0.28	\$0.43	\$0.49
Economic life years	25	16	24

SOURCE: Ammonite Resources

## Internal Rate of Return

After Tax With Section 29 Tax Credit

Black Warrior	%
Good Well (6.5%)	50
Good Well (15%)	50
Good Well (15% promoted)	34
Average Well (15%)	40
Average Well (15% promoted)	28

SOURCE: Ammonite Resources

**4. Communicate**

**5. Establish cooperative  
effort**

COALBED METHANE PRODUCTION - AN OPERATOR'S PERSPECTIVE  
PART I

JOHN A. WALLACE  
VICE PRESIDENT-METHANE OPERATIONS

Good morning! It is a pleasure to be here, although for an Alabamian who doesn't snow ski, a seminar in June would have been a more appropriate time for a trip to Calgary.

When Dennis Nicols telephoned and asked me to speak at this meeting, he indicated it was his hope to provide a seminar that would address coalbed methane development from the standpoints of basic geology, the research efforts that have been carried out in the United States, the involvement of regulatory agencies in methane development, current developments within the USA, and a producers viewpoint. During the morning sessions yesterday you heard Keith Murray describe the basic geology of coalbed methane and what currently is happening throughout the USA in regard to coalbed methane development. Yesterday afternoon Stan Graves shared the history of methane development in Alabama, what was required from industry and academia in regard to research, how a set of regulatory protocols had to be established with the appropriate agencies to set the stage for methane development, and the current status of development in Alabama. This morning I will attempt to focus on methane development from a producer's standpoint. To do so I'd like to tell you just a bit about Taurus, look at the reservoir mechanics of coalbed methane production, turn to implications those mechanics have on a producer's evaluation of a potential project, and finish with what Taurus looks for in the structure of a deal. I expect to complete my description of Taurus and reservoir mechanics before the break and turn to the implications and deal structure afterwards.

To me, use of the word producer in regard to coalbed methane implies both the owner/investor or the operator of a project.

Taurus fulfills both those roles. We are a wholly owned subsidiary of Energen Corporation, an energy centered diversified holding company headquartered in Birmingham, Alabama and listed on the New York Stock Exchange. Energen has two major lines of business. The first is natural gas sales and distribution through Alabama Gas Corporation, its utility subsidiary, while the second is oil and gas exploration and production through Taurus Exploration. In addition Energen is involved in intrastate transportation of gas through Basin Pipeline Corp. and high temperature combustion products through American Heattech.

Taurus has been involved in conventional oil and gas production since 1971 as both an investor and operator. Currently it owns interests in about 215 non coalbed methane wells throughout the United States with ongoing activities in Alabama, Louisiana,

Montana, Texas, and West Virginia. Production from traditional reservoirs during our fiscal 1989 amounted to two BCF equivalent while year end conventional reserves were 14 BCF equivalent.

Taurus first entered the coalbed methane business in January 1986. It had watched the early development of the technology in Alabama by organizations such as the United States Bureau of Mines, the US Department of Energy, the University of Alabama, and the Gas Research Institute. As the technology progressed during the early 1980s Taurus made the decision to obtain a land position and secured a 125,000 acre lease from United States Steel in late 1985. Drilling operations began with a combination corehole and well in February 1986 with actual development drilling for a thirty well program beginning in April. Gas sales from the project began in July of that year. The first thirty wells were followed by 120 more over the two year period ending in June of 1988. Together these 150 wells came to be known as the TEAM (Taurus Energen Alabama Methane) Project.

In May of 1986 as our TEAM Project was getting well underway, Taurus became a contract operator of a 31 well coalbed methane project owned by TRW Corp at the Deerlick Creek Degasification Field located some 30 miles southwest of our Team site. TRW had developed this field during the early 1980s with some of the first multiple zone methane wells in the state. A strategic decision to focus upon their core businesses led TRW to seek a contract operator and Taurus was pleased to accept this role which we continue in today.

In January of 1987 Taurus became on site manager of the Gas Research Institute's Methane from Multiple Coal Seams Project at Rock Creek, Alabama only a few miles away from our TEAM Project site. This GRI project is directed toward further advancing the technology of coalbed methane production and particularly towards the better definition of reservoir mechanics and appropriate hydraulic fracturing techniques for multiple coal seams. This project is continuing today and is serving as a field laboratory for technology development for all of GRI's coalbed methane research contractors.

In July of 1988 as the result of the success of the TEAM Project and our involvement with GRI, Taurus was able to enter and begin a Joint Venture with Amoco Production Company for the continued development of the USSteel leasehold. Under the terms of the venture Amoco is drilling and operating half of the additional wells while Taurus is drilling and operating the other half. As of the end of 1989, a total of 325 wells have been drilled as part of this venture. Taurus had drilled 162 of them and was selling gas from 103 with the remainder in some stage of development between spud and start of gas sales.

Last spring Taurus acquired the assets of a privately held methane production company in Tuscaloosa, Alabama. Those assets included 18 producing wells and an 80 percent working interest in 15,000 acres

of potentially developable coalbed methane properties. In July we announced the establishment of a joint venture to develop these properties with TECO Coalbed Methane, a subsidiary of TECO Energy of Tampa, Florida, and Gulf States Paper, the owner of the land who had retained the remaining 20 percent working interest. Taurus serves as operator of this project. Since July we have drilled 53 development wells on a proven portion of the acreage and installed two five well pilots on other parts of the property where little is known about the productive potential of the coal seam reservoir. Gas sales from the development area are expected to begin late next month with the completion of a lateral pipeline which is being installed by Southern Natural Gas who will be the customer for our production from this project. Reservoir and initial production testing of the two five well pilots is proceeding well and we are expecting to begin development drilling in one of these two areas by the end of February. If the results continue to be positive, we expect to drill another 150 wells by year end.

Just last week we announced a third joint venture for development of a property block immediately north of our Gulf States/TECO Project. TECO will again be one of our partners in this venture with Chevron U.S.A. being the other. Development drilling in this area is well underway with 25 wells drilled to date. Subject to successful negotiations for additional leases we anticipate this project may drill another 175 wells by year end.

Thus by the end of this year Taurus expects to be operating as many as 700 methane wells in projects we have already defined and have well underway. It would be correct to say that Taurus is committed to coalbed methane and believes the coalbed reservoir is one worth developing. But it is equally correct to say that we do not believe the mechanics of the coalbed reservoir are the same as those found in traditional reservoir rocks and as such believe coalbed methane development must couple many of the techniques of the oil and gas industry with coal geology and science. I want to take the remainder of this first session and talk about how coalbeds and gas production from them differ from traditional reservoir rocks.

To begin I must set the stage by discussing how gas is stored in coal, a process called adsorption, and about the ability of coal to permit gas and coproduced water to flow through it. Each of these subjects could take several days of seminars so I will apologize beforehand by saying that my explanations may be too simple for the reservoir engineers here this morning and too long for those of you who are not required to deal with reservoir mechanics. As I indicated earlier I am trying to define some basic concepts and then show you how they apply.

First let us consider the difference in gas storage capacity of coalbeds and traditional reservoir rocks. Because the specific gravity of coal is considerably less than rocks such as sandstone or limestone we will look at gas storage capacity in terms of gas volume per unit of rock volume rather than per unit of rock weight.

This slide depicts the gas volume which can be held by 25 cubic feet of rock at increasing pressures. The orange colored line represents what a sandstone of 20 percent effective porosity can hold while the green zone represents what a medium volatile coal can hold. As you see the sandstone's capacity is linear with pressure while the coal shows a exponential relationship which ultimately approaches an asymptote. Thus at relatively low to moderate pressures, coalbeds can hold more gas per cubic foot of rock than can traditional reservoir rocks. This phenomenon is the result of the extremely large internal surface area of the coal matrix and the sorptive storage of methane on the carbon rich matrix present within coal. It is this sorptive capacity that makes coals a different kind of reservoir than the traditional clastic and carbonate rocks.

If we consider that not all coals are of equivalent age or maturity, we can further examine this sorptive relationship. This slide depicts the storage capacity of coals of various levels of maturity. This time the units are expressed in cubic feet of gas per ton of coal. With an in place density of 80 pounds per cubic foot one ton of coal occupies the 25 cubic feet of volume we used on the last slide. For the non coal geologists present let me say that maturity in coals is measured in terms of rank with lignite being the least mature, semi-bituminous the next, bituminous the third, and anthracite being the most. Within the bituminous category, three subcategories exist which are designated as high volatile, medium volatile, and low volatile. The lower the volatility the more mature the coal. As the slide shows the lower the volatility the more gas coal can store at the same pressure. Recognize that these curves, which are called isotherms, represent laboratory conditions and may not be what is encountered in-situ. Within the earth coals may exist at underpressured, normal pressured, or overpressured conditions. If the coal is underpressured, the amount of gas held will be less than that which can be sorbed in the laboratory. Under normal pressured conditions the insitu storage will closely approximate the isotherm. And at over pressured conditions some free gas will be present within the macroporosity once the sorptive capacity of the micropores is exceeded.

Let us now look at the impact of insitu pressure conditions on the potential producibility of coalbed reservoirs. If we first consider overpressured conditions, we are confronted with a combination reservoir where some significant quantity of gas exists in the macroporosity of the coal matrix and additional gas is stored by adsorption within the microporosity. During the early life of a coalbed methane well drilled into an overpressured reservoir well performance will be similar to a conventional volumetric drive gas reservoir. Flush production rates will be quite high and may last for significant periods of time. It is not until the pressure has been reduced to the level of the isotherm that desorption will begin and production characteristics more similar to most coalbed reservoirs will be observed.

After this flush production, the performance of a well drilled into an overpressured coalbed will resemble that of a well drilled into a normal pressured coalbed. In this case desorption must occur for gas to be produced. Such desorption can be achieved by lowering the pressure in the reservoir by removing the water which is present. At this point two phase flow is instituted and both gas and water production can be achieved. The ratio of gas to liquid will change with time subject to the relative permeability relationship of the two fluids. I will be discussing the importance of the relative permeability relationship in just a few minutes. But before I do I want to point out the significance of the non linearity of the isotherm in regard to the amount of gas which can be produced for a given pressure reduction. At the top of the curve where the slope is relatively flat and the concentration of methane per unit of coal is highest, a reduction of 100 psi will allow only a minor portion of the gas to desorb. However, as pressure is further reduced and desorption continues, the steeper portion of the isotherm will come into play. At this point an equivalent 100 psi reduction in pressure will significantly increase the amount of methane which desorbs. Thus the greatest production per unit of coal can be achieved as reservoir pressure is lowered further. This phenomenon is not unlimited because at some point the pressure drop which the desorbed gas must overcome to reach a wellbore exceeds the remaining sorption pressure.

The need to reduce pressure to isotherm levels in order for gas to be desorbed and produced makes underpressured coalbeds a test of an operator's patience. Remembering that the isotherm is a laboratory derived measure of sorption capacity, it does not imply that the concentration in situ will be at isotherm levels. When underpressured conditions exist the pressure must be reduced to the level of pressure corresponding with the concentration before desorption can begin. Thus considerable time may be spent producing only water from a well drilled into an underpressured reservoir before desorption and accompanying gas production begins. In the Warrior Coal Basin of Alabama most of the coal is in fact underpressured and some dewatering time is required before gas production is obtained. We normally think of 30 days of dewatering being normal but have seen instances of six months to a year in some occasions.

I am not a physical chemist and as such am not prepared to discuss the rates at which desorption occurs but I am an engineer who can say that in the Warrior Basin to date the problems we have faced have not been the result of slow rates of desorption. What has caused us problems is limited flow capacity within the coal after desorption occurs. For those nonengineers who are here this morning let me say that the capacity of a rock to permit fluid flow through itself is called permeability. The unit of measurement of permeability is the darcy or some fraction of it. In simple terms the darcy unit represents that flow capacity required for one milliliter of water to flow through a specimen having a surface



area of 1 square centimeter for a distance of 1 centimeter when one atmosphere of pressure is applied.

Having now defined the term let me say a few things about permeability in coal seams.

1. It is relatively low compared to many reservoir rocks normally occurring in a range of 1 to 60 millidarcies
2. It can vary significantly from one coal seam to another within the same wellbore again ranging from 1 to 60 millidarcies
3. It varies within a given coal seam from area to area at distances of less than a mile in a range of 2 to 20 millidarcies.
4. In a given well it is not necessarily radially uniform and may exhibit anisotropic ratios of 4 to 1.
5. Because coalbed methane production almost always includes coproduced water, the absolute permeability must be shared by the gas and water phases.
6. The sharing of permeability is not equal and varies with the ratio of gas to water present.
7. Sharing of the absolute permeability introduces the concept of relative permeability whereby as the gas to water ratio increases across a limited range so does the portion of the absolute permeability available for gas flow.
8. However outside that limited range, changes in the gas to water ratio will not result in changes to relative permeability.
9. Measurements of absolute permeability obtained in the laboratory from coal core specimens are not representative of what is found insitu.
10. Measuring permeability via wellbore testing requires extremely careful experimental techniques and complicated analytical procedures.
11. Normally permeability measurements are made early in the life of the well so that the complexity of two phase gas and water analytical techniques can be avoided and liquid phase three dimensional reservoir models can be used in the analysis.
12. After determination of absolute permeability using single phase analysis, the relative permeability can be reasonably estimated from testing of coal cores.

13. Permeability is one of the most significant parameters effecting the rates at which gas can be produced from coal seams and the ultimate reserves of any coalbed methane well.

Given the significance of permeability relative to producibility of coalbed reservoirs and the great difficulties associated with determining what it is, verification of values determined from wellbore testing is normally required. Such verification is obtained using history matching of gas and water production together with sophisticated reservoir models. Thus, development of a coalbed methane project generally requires installation of several pilot wells followed by reservoir testing to determine coal maturity, gas content, reservoir pressure, and both absolute and relative permeability followed by a period of test production to develop data for history matching and verification of measured permeability values.

Having now completed the basics of gas storage by adsorption and permeability let us now turn to their impacts on gas production from a coal seam. This slide represents what happens within the coal when a well is drilled into it and a dewatering pump installed to remove the coproduced water. Note the steep angle of the pressure trace leading away from the well bore. The degree of steepness is the result of the generally low permeability of the coal. This particular slide is based on data from the Blue Creek seam in the Warrior Basin of Alabama in an area where the absolute permeability is in the range of 10 to 20 millidarcies. You can see that within about 500 feet of the wellbore there has been little reduction in pressure. If you remember my discussion of the non linearity of the isotherm, you will recognize that in this case the amount of coal exposed to the low pressures required for significant desorption is relatively small. That being the case, after a short period of time the rate of gas production would fall significantly. As a developer of coalbed methane the economics of this situation would not be very encouraging. So the question becomes what can we do about it?

An examination of this slide begins to answer the question. This time we are looking at pressure traces at two different times in two wells separated by a distance of 2,500 feet. The xxxxx line represents the pressure traces at an early point in time and are duplicates of those you saw on the single well slide. The xxxx line represents the pressure traces at a later point in time and show several significant differences. Look first at the traces between the wells as compared to those outside each well. With time the influence of one well on the other to reduce the overall reservoir pressure will allow more desorption to take place and improve the economics. However an examination of the outside traces indicates that they are mirror images of each other and again duplicate those seen in the single well slide. Thus two wells may not impact enough of the reservoir to provide adequate gas flows. If however even more wells were drilled along a line, a greater and greater percentage of the reservoir could have its

pressure lowered to permit increases in gas production. The only problem is, this is not a two dimensional world. A single line of wells must contend with an infinite reservoir in the other direction.

This slide is not scaled but is a graphical representation of the pressure profiles which can be obtained when multiple lines of wells are drilled. Note the orange and green geometric planes representing the pressure profiles between wells. In the five spot represented by the slide, the center well has the greatest of all pressure reductions and would be expected to produce the most gas in the shortest time.

The implications of this phenomenon are profound to coalbed methane development. Unlike conventional reservoirs where operators attempt to avoid one well interfering or draining another, in coal seams you can achieve the highest production rates and greatest recovery of gas by spacing wells in such a manner that the pressure throughout the reservoir can be reduced by the interference of multiple wells upon each other. Thus the question for a coalbed methane developer becomes how to space the wells to achieve that interference within a reasonable period of time so that the discounted value of revenues received will provide an adequate return on the investment required to install the wells at the spacing chosen. It is at this point that the worlds of engineering and economics meet, or in the words of an United States tire manufacturer "where the rubber meets the road."

I mentioned earlier that the GRI research project has as one of its primary goals the definition of the most appropriate hydraulic fracture designs for coalbed methane production. This focus results from the fact that with the exception of a few overpressured areas of the San Juan Basin in Colorado and New Mexico, coalbed methane developers have never been able to produce significant quantities of gas without hydraulically fracturing the wells. Given the low pressure production regime of coalbed methane production and the generally low permeabilities of the coalbeds being produced, the energy available to cause the gas to flow is insufficient to provide economically attractive rates without application of hydraulic fracturing to extend the low pressure area created by the wellbore.

The impact of hydraulic fracturing is graphically displayed on the next few slides. The low pressure surface area created by a well of 8 inch diameter which has not been hydraulically fractured amounts to about 2.1 square feet per foot of coalbed height. That is not sufficient to permit adequate production rates to be obtained. A hydraulically fractured well on the other hand can create a low pressure surface area of at least 1200 square feet per foot of coalbed height. This surface area is created by the wing like extensions of hydraulic fractures with lengths of 300 feet per wing. The potential to create wings of this length has been demonstrated by a number of mine backs of hydraulically fractured wells in the Warrior Basin. A graphical representation of the

impact of this 600 fold increase in low pressure surface area on a multiple well project laid out on 80 acre spacing can be seen on the next two slides.

In a field without hydraulic fractures low pressure would exist at each well bore but some of the coal between wells would be as much as thirteen hundred feet away from the low pressure sink provided by the well bore. In a hydraulically fractured field the low pressure will be extended out from the well bores some 300 feet in each of two directions and most of the coal would be within 1000 feet of the low pressure sink. Furthermore the low pressure area will be much larger and thereby result in a much larger pressure differential for more of the coal between wells. The geometry alone does not do justice to the impact of hydraulic fracturing on coalbed methane production. It can be truly said for most coal basins in the United States, without hydraulic fracturing there can be no economical gas production.

Now lets conclude this first session by summarizing a few of the key points I've discussed this morning. After the break we will turn to the implications of this session on the manner in which a producer can develop a coalbed methane project. The significant points to remember are:

1. The more mature a coal is the more methane it has the capacity to hold.
2. Coal seams are usually low pressure reservoirs.
3. Coal seams can hold significantly more gas at low pressures than traditional reservoir rocks.
4. Coalbed methane production requires that the pressure in the reservoir be lowered significantly to produce gas.
5. The best production rates and highest reserve recovery can be obtained in coalbeds by positioning the wells to interfere with each other.
6. The permeability or flow capacity of coal is relatively low.
7. Coalbed methane production is accompanied by coproduction of water so the absolute permeability of the coal must be shared by the gas and water.
8. The permeability of coal is difficult to measure and must be verified by production history matching.
9. The key question for coalbed methane developers is how to space their wells in this low permeability reservoir to acheive the required pressure interference between wells without investing more capital than the recoverable reserves can support.

10. Almost all coalbed methane wells will require hydraulic fracturing to achieve economic production rates.

**TAURUS**

**EXPLORATION, INC.**

**AN ENERGEN COMPANY**

# Engineering + Economics

- Spacing
- Interference
- Revenues
- Investment

**TAURUS**

## Surface Area of An Unfractured Wellbore

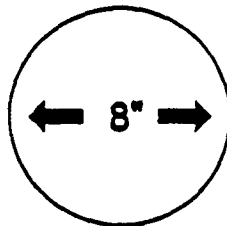

2.1 ft<sup>2</sup> /ft of height

**TAURUS**

**ENERGEN**

**Coalbed Methane  
Production:  
An Operator's Perspective**

**TAURUS**



# TAURUS

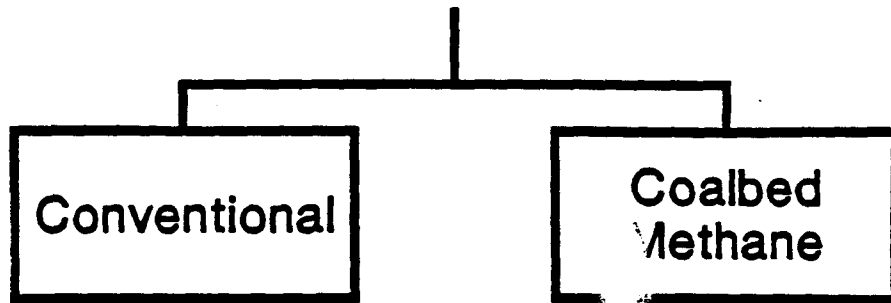

**TAURUS**

## Taurus

- Owner/operator

**TAURUS**

# Taurus

- Owner/operator
- Contract operator for TRW

**TAURUS**

# Taurus

- Owner/operator
- Contract operator for TRW
- Project manager for GRI

**TAURUS**

# Taurus

- Owner/operator
- Contract operator for TRW
- Project manager for GRI
- Joint venture with Amoco

**TAURUS**

# Taurus

- Acquisition of assets

**TAURUS**

# Taurus

- Acquisition of assets
- Joint venture with  
TECO/Gulf States

**TAURUS**

# Taurus

- Acquisition of assets
- Joint venture with  
TECO/Gulf States
- Joint venture with  
Chevron/TECO

**TAURUS**

# **Coalbed Methane Development**

- **Worthwhile**
- **Different from traditional**
- **Combine oil & gas techniques  
with coal geology & science**

**TAURUS**

# **Coalbed Methane**

- **How it's stored**
- **How it moves**

## Gas Storage Capacity vs. Pressure

Coal Adsorption Compared to 20% Effective Porosity Sandstone

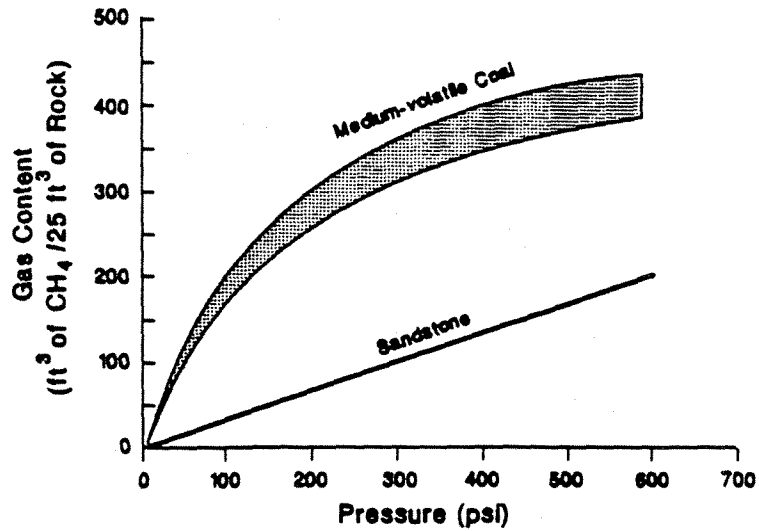

**TAURUS**

## Gas Content vs. Coal Rank -- Idealized Case

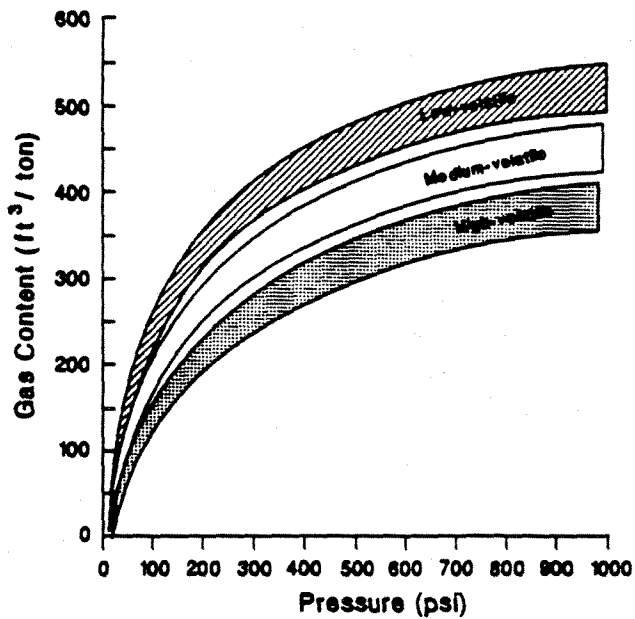

**TAURUS**

# Overpressured Reservoir

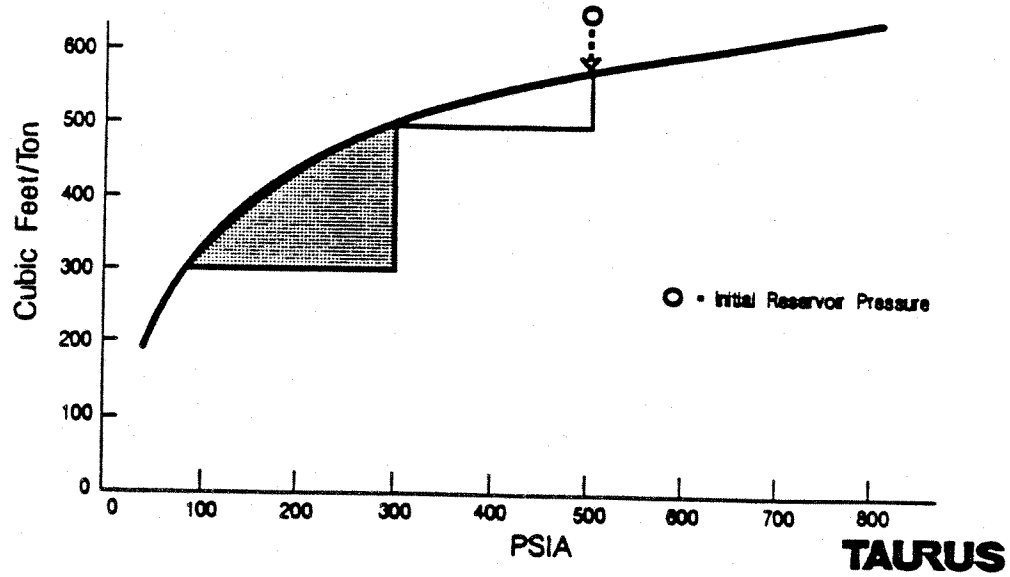

# Underpressured Reservoir

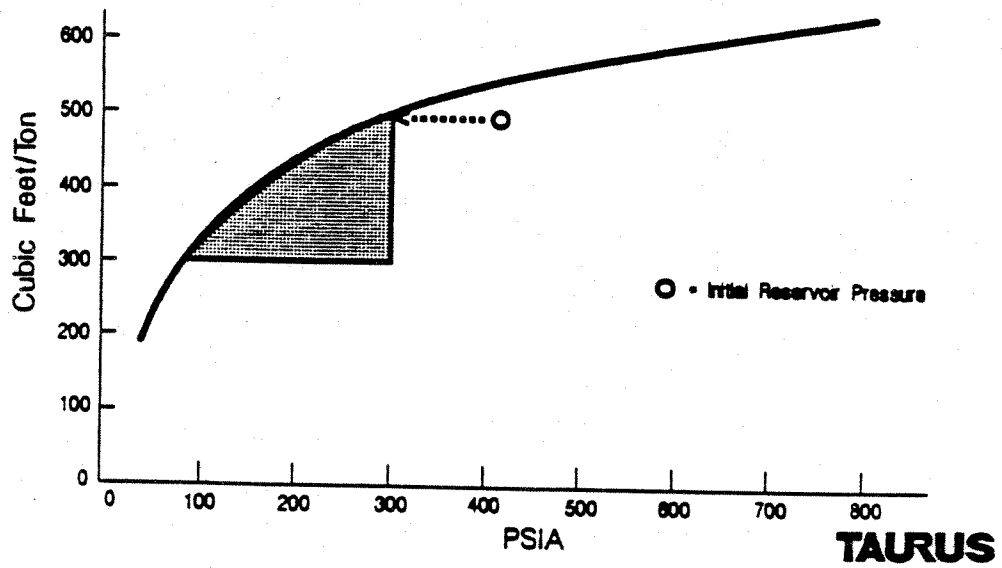

## **Permeability:**

capacity of a rock to permit  
fluid flow through itself

**TAURUS**

Darcy unit represents flow  
capacity required for 1 ml.  
of water to flow through  
1 sq. cm. for distance of  
1 cm. when 1 atmosphere  
of pressure is applied

**TAURUS**



**Varies significantly  
from seam to seam**

**TAURUS**

**Relatively low**

**TAURUS**

**Varies within seams  
geographically**

**TAURUS**

**Potentially anisotropic**

**TAURUS**

**Sharing varies with  
gas-to-water ratio**

**TAURUS**

**Absolute permeability  
shared by gas and  
water**

**TAURUS**

**Sharing defined by  
relative permeability  
curves**

**TAURUS**

**Outside limited range,  
no change in relative  
permeability**

**TAURUS**

**Coal core not  
representative of  
insitu**

**TAURUS**

**Permeability testing  
demands precise  
techniques and  
complicated analysis**

**TAURUS**

# Well Bore Permeability Measurements

- Early life single phase  
three dimensional models

**TAURUS**

# Well Bore Permeability Measurements

- Early life single phase  
three dimensional models
- Relative permeability estimated  
from coal cores

**TAURUS**

## **Permeability Affects:**

- Production rates
- Reserve recovery

**TAURUS**

## **Verification**

- History matching and models
- Pilot wells
- Test production

**TAURUS**

# Single-Well Pressure Drawdown

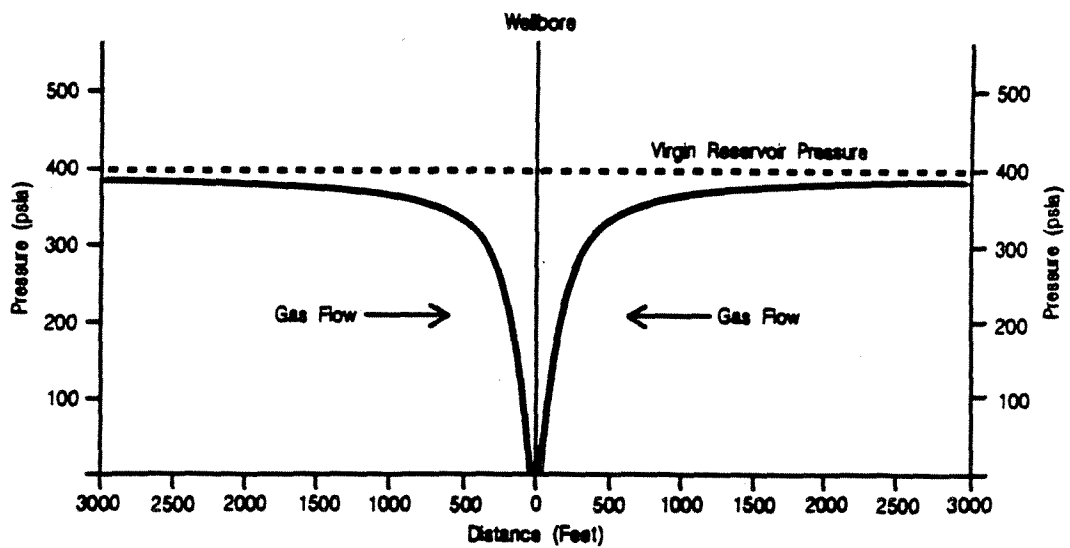

TAURUS

# Two-Well Pressure Drawdown

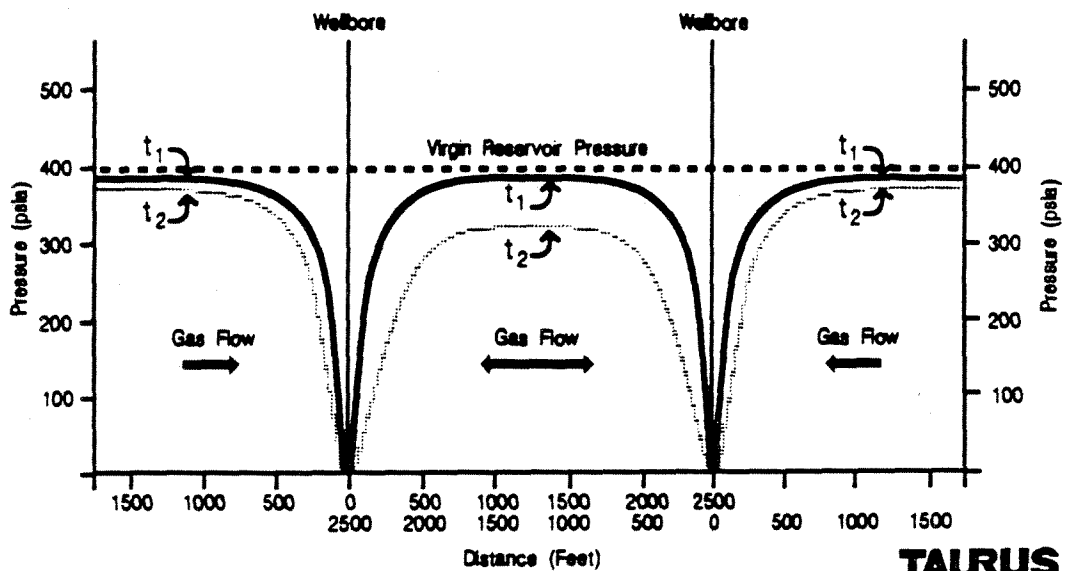

TAURUS



## Multi-Well Pressure Drawdown

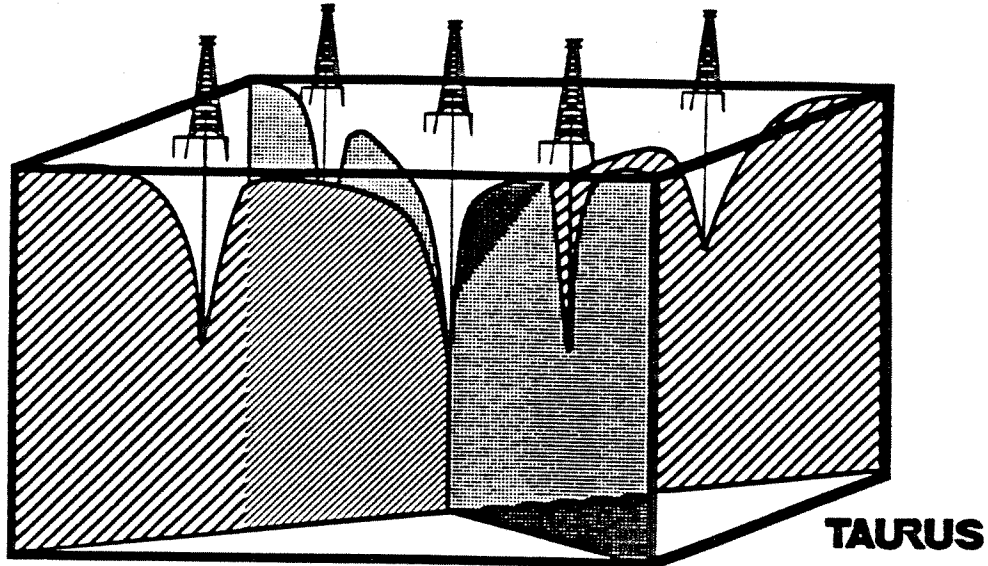

## Well-to-Well Interference Provides:

- Highest production rates
- Greatest reserve recovery

TAURUS

# Engineering + Economics

- Spacing
- Interference
- Revenues
- Investment

**TAURUS**

## Surface Area of An Unfractured Wellbore

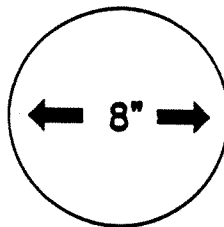

2.1 ft<sup>2</sup> /ft of height

**TAURUS**

## Surface Area of Multiple Unfractured Wellbores

(80-acre spacing)

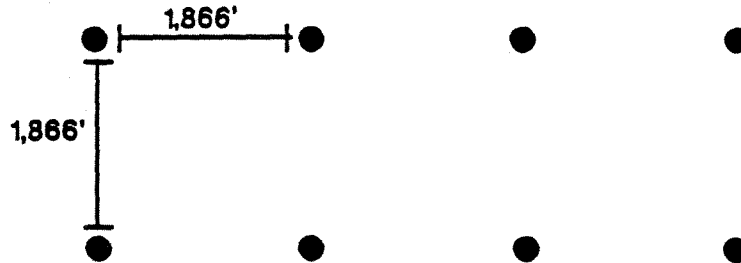

Not to scale

**TAURUS**

## Surface Area of A Fractured Wellbore

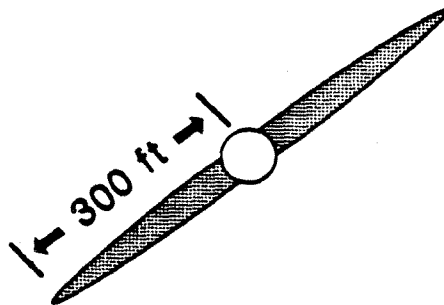

1200 ft<sup>2</sup> /ft of height

Not to scale

**TAURUS**

## Surface Area of Multiple Hydrolically Fractured Wellbores

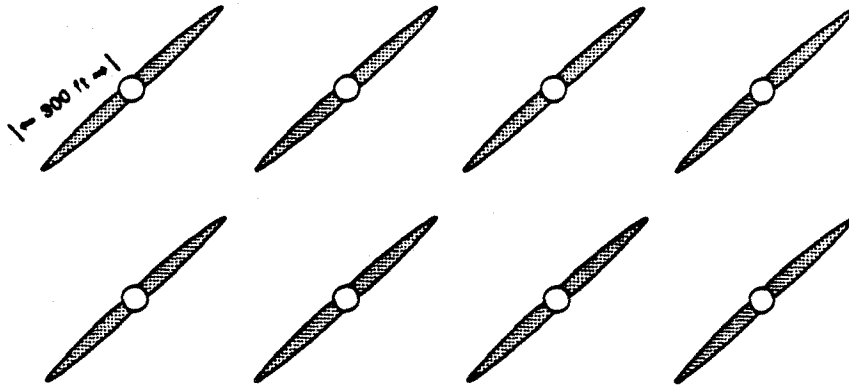

Not to scale

**TAURUS**

1. Capacity proportionate  
to maturity

**TAURUS**

## **2. Low-pressure reservoir**

**TAURUS**

## **3. Higher capacity than traditional reservoir**

**TAURUS**

## 4.Reduced pressure

**TAURUS**

## 5.Interference enhances production and recovery

**TAURUS**

## 6. Low permeability

**TAURUS**

## 7. Shared absolute permeability

**TAURUS**

**8. Permeability verification  
by production history  
matching**

**TAURUS**

**9. Spacing crucial to  
economic production**

**TAURUS**



**10. Hydraulic fracturing  
required for economic  
production**

**TAURUS**

COALBED METHANE PRODUCTION - AN OPERATOR'S PERSPECTIVE  
PART II

JOHN A. WALLACE  
VICE PRESIDENT-METHANE OPERATIONS

Welcome back to part two of a producer's view of coalbed methane production.

When I began this morning I indicated we would use most of the first session to discuss the reservoir mechanics of coalbed methane production to set the stage for discussing the implications of those mechanics on the development of a coalbed methane project. At this point I hope I accomplished that objective because I now want to examine those implications.

During my earlier remarks I showed how the maturity of coal plays a significant role in defining how much methane might be present in any given area and that the potential for economic production is dependent on the ability of the coal to permit gas to flow through itself. On that basis any potential developer will need to conduct a pilot program to determine how much gas is present and what the absolute and relative permeabilities of the coal within the prospect area are. I also pointed out that coalbeds are relatively low pressure reservoirs and that multiple wells with very low wellbore pressures will be required to sufficiently reduce the pressure in large areas of the reservoir in order to obtain high production rates and good reserve recovery. In addition I identified that coalbed methane production is almost always accompanied by coproduced water.

Let's take a few minutes and discuss some of these issues in more depth in order to define their implications on potential development of coalbed methane.

I would be most surprised if there is not a lot more information about the location, thickness, quality, and maturity of the coals here in Alberta than there is about how much gas is present in those coals and what the absolute and relative permeability of those coals are. Therefore, the potential for development of coalbed methane would be significantly enhanced if methods were available to predict gas content and permeability from existing data. Currently this is a good news/bad news situation. The good news is that coal maturity is a good indicator of the potential for significant quantities of methane to be present. The bad news is that until gas contents are determined by core recovery and desorption of gas from that core, using methods developed by the U. S. Bureau of Mines, actual gas content can't be accurately established.

In regard to absolute permeability the good news is that United States experience can be used to suggest that gently folded areas

tend to have better permeability than steeply folded and faulted areas. Furthermore, information relative to the coal's cleat spacing and size are also useful in predicting permeability in relative terms. Generally the larger the cleat size and the higher the cleat density the higher the permeability will be. The bad news is that until actual insitu permeability measurements are obtained and verified using reservoir modeling of pilot production histories, numerical values of absolute permeability will not be available.

In terms of relative permeability the bad news is that it can't be estimated without laboratory testing of coal cores. The good news is that if you've recovered core to obtain gas content information, that core can be used to develop the relative permeability curves.

With these concepts in mind, the good news implication for a potential producer of coalbed methane is that target areas for detailed exploration and pilot wells can be identified from currently available information. The bad news implication is that specific identification of the highest potential areas will require significant investment for the exploration programs.

Coupling this inability to specifically identify the highest potential areas with the low pressure characteristics of coalbed reservoirs and their associated production mechanisms establishes additional implications for potential coalbed methane developers. Given the need for multiple wells to provide the pressure reductions required for high production rates and good reserve recovery, any potential coalbed methane project must include sufficient acreage to develop a large number of wells. Without specific knowledge as to the permeability, which in turn would be used to define the appropriate spacing of wells, it is impossible to predict the minimum acreage required for an economically attractive coalbed methane project. However, if the permeability versus gas content and investment required were such that eighty acres per well were appropriate, the minimum acreage needed for a single project would be 10,000 acres with 20,000 acres being three to four times better. I am not familiar with your Federal and provincial leasing terms or licenses to prospect but it may be necessary to modify them to include larger blocks of acreage for coalbed methane projects.

The need for multiple wells also generates another problem. I am sure that the climatic conditions here in Alberta limit the length of your drilling season each year. I don't know the details but I wonder how many wells could be drilled and put on production within a given year. This problem is intensified by the low pressure production regime of coalbed reservoirs. This low pressure regime requires that the coproduced water be pumped from the wellbore rather than lifted by gas velocities. This in turn requires the availability of a prime mover at each well site and the ability to repair or replace the pumps throughout the year.

In terms of the prime movers it might appear gas fired engines could be used, but as produced, the coalbed methane will be about 50 percent saturated with water vapor and using it for fuel gas will almost undoubtedly result in freeze up. In addition this saturation level will cause significant gas handling problems at the wellhead and throughout the gas gathering and compression facilities. The potential for condensation and probable freezing of the produced water vapor would require all wellhead equipment to be enclosed, insulated, and probably heated throughout the winter months. The gas gathering lines would have to be buried below the freeze line and even then condensation of the water vapor remaining in the gas after it leaves the wellhead would be likely. As an alternative, compressors could be installed at each well together with dehydration facilities, but this alternative would add significantly to the investment required and like the pumps would require an ability to access the wellsite throughout the year for repair and maintenance of the compressors and dehydration equipment.

Handling of the produced water would also be extremely difficult during the winter. As Stan indicated yesterday you can expect some mineralization of the water and disposal of it in an environmentally acceptable manner will be a challenge in itself. But regardless of the technique used for disposal, gathering and treatment of the water will be made extremely difficult by subfreezing temperatures.

Some of you may be thinking that the best way to deal with the problems associated with subfreezing temperatures is to shut down during the winter. That strategy has two problems--one which is readily apparent and the other not as easily recognized. The apparent one is, that in terms of the producer's economics, the price and takes available for the product are seasonal and are most favorable during the winter months. The less apparent problem is reservoir related. Given the low initial pressure of coalbed reservoirs, any production from them significantly reduces the energy available to drive gas to the wellbore. Experience in both the Warrior and San Juan Basins indicates that once production of coalbed methane has been initiated, temporary shutdown for any reason is adverse to well performance, and production rates after a restart will not match those observed before the shutdown.

My comments relative to gas gathering and compression point out another implication of the low pressure production regime of the coalbed methane reservoir. Wellhead pressures for coalbed methane production will be low and the gas will require compression. Normally wells in the Warrior Basin are operated at pressures of less than twenty pounds while wells in the San Juan Basin are operated at less than seventy five pounds. In either case, but particularly in the Warrior, these low wellhead pressures require larger diameter gathering lines than are normally used in conventional gas production and the gas must be compressed before it can be delivered to market. Both of these requirements require significantly more front end investment for gas handling in any

methane development than would be experienced in a conventional gas play. In addition the compressors will impose an ongoing requirement for fuel or power which will impact overall project economics.

Another implication of the low pressure reservoir is that the wells will produce at modest rates over a long period of time. On that basis, normal practice in the US has been to develop the infrastructure required for longterm operation during the development of the project. I'm talking particularly about installing lease roads and rights-of-way, gathering lines, compressor stations, and pipelines in a manner that anticipates long term use. Currently the oldest wells in the Warrior Basin have produced for about twelve years. These wells were installed on 25 acre spacing as part of an experimental program and are now reaching their minimum economic limits. No wells have been produced to depletion on spacings wider than the 25 acres. However, based on experience from this tight spacing, current thinking in the States is that economic production can be obtained from more widely spaced wells for periods of up to 25 years. On that basis, installation of good quality roads and facilities can play a significant part in minimizing long term operating costs.

All of these implications associated with production from the low pressure reservoir and the problems with winter weather add up to the most important implication to potential producers of coalbed methane. This most important implication is that coalbed methane has an extremely high operating cost compared to conventional gas reservoirs. The requirements for pumping, disposing of water, compressing the gas, and maintaining all of the required equipment leads to operating costs between \$.65 and \$.95 per MCF. That being the case, any economic picture of a coalbed methane project will look far different than one of a conventional gas play. Given that the two components of the cost of production are finding costs and lifting or operating costs, the high operating costs associated with coalbed methane production demand an offset in lower finding cost if coalbed methane is to be competitive with traditional gas reservoirs.

Finding cost is another good news/bad news situation. The good news is that because the locations of coal seams are already generally well known and in place gas content of those seams can be established with a modestly priced core drilling and gas desorption program, the exploratory cost associated with finding coalbed methane is quite low. The bad news is that just because the gas is present does not mean it can be produced. Unless the absolute and relative permeabilities of the coal seam are sufficiently high, in place gas content alone is not the basis for calculation of finding cost. It is only that gas which can be recovered at a profit that can be used to divide into the total project investment including exploratory cost to establish the finding cost. Whatsoever this problem is exacerbated for a publicly held company which must publish quarterly and annual income statements that reflect the

amortization of finding cost as an expense or reduction in profit.

Chief Financial Officers of publicly held companies and the Securities and Exchange Commission tend to be conservative in accepting an engineer's definition of how much coalbed methane can be recovered. In addition, development of reservoir models for coalbed methane production is still a relatively young endeavor and no commercially available coalbed methane reservoir models have been sufficiently proven for acceptance by the financial community.

These factors being the case, a conservative bias is usually applied throughout the methane industry in establishing and booking reserves. Ultimately as technology improves and more wells are produced to depletion it may be determined that the recovery actually obtained before depletion is greater than the values now being used but in the meantime, definition of finding cost tends to be conservative. This means that the economic picture for coalbed methane projects which I mentioned earlier tends to be fuzzy. It is only those projects where sufficient gas content exists that, even at low recoveries, calculated finding costs will offset the high operating costs. Thus, at this point in time the economics of coalbed methane direct publicly held companies toward only those projects with large amounts of gas in place and the potential for recoveries greater than what can currently be booked. Obviously the future of the coalbed methane industry can be enhanced by reducing operating expense but the highest potential for making more coalbed methane projects economically attractive is to better define and increase the recovery of the gas in place.

I indicated during my opening remarks at the first session that I would close by speaking about deal structures. I'll do that now and then attempt to answer any questions you might have.

Some of you have probably heard of the Section 29 Nonconventional Fuel Tax Credit now existing in the USA which is supporting the development of coalbed methane. Its purpose is to provide a price floor for development of new energy sources. The credit is applicable against Federal income taxes and is earned on all production before the year 2001 from methane wells or other nonconventional energy sources installed before the end of this year. This credit and some of the esoteric provisions of the Federal Tax Code in the USA has led to some extremely complicated deal structures over the past few years. Those deal structures are not representative of what would exist without the existence of the credit and as such I'm not going to spend time discussing them today. I would like to discuss some underlying principles for building deal structures for a resource such as coalbed methane where the history of the technology is short and opportunities exist to improve economics by continuing to advance the technology.

As is the case in any business venture, the deal structure for coalbed methane projects must appropriately balance the risk versus reward profile for the various participants. In a coalbed methane

deal those participants will usually be the operator/developer, investors, and the mineral owner. Often times the operator will also be the, or one of the, investors. My earlier comments during this session regarding the level of ongoing operating costs suggest that in those cases where other investors are funding all or portions of the project it is important that the operator be incentivized to produce the largest quantities of gas at the lowest possible operating cost. Therefore in projects where the operator has less than a 50 percent working interest one technique which can be applied is to provide some sort of fee based on operating profits. Where the operator is more than a 50 percent working interest partner, he will generally already be incentivized to maximize production while minimizing operating costs so this type of incentivization may not be required.

As an investor and operator, Taurus believes one of the most important elements in the potential success of any coalbed methane project is the knowledge and talents of the operator. I hope that my remarks this morning have indicated to you that production of coalbed methane is different from conventional gas production. While many of the same skills and talents are required for both coalbed and traditional reservoirs there are skills, talents, and knowledge specific to coalbeds that developers of traditional reservoirs do not possess at this time. Therefore, before Taurus would invest in a coalbed methane project to be developed and operated by another company, we would require that company to have a demonstrated history of successful coalbed methane development, preferably using their own money, and we would want the deal structured to provide additional rewards to the operator only when our return was also increased.

The relationship between the operator/investors and the mineral owner is also somewhat different for coalbed methane than for traditional oil and gas projects. Even with the successes to date in the USA, coalbed methane is still a relatively young technology and much remains to be learned about how to exploit it in those coal basins where production has not yet been demonstrated. At this point in time, coalbed methane is a resource at best and converting it to a profitable reserve will require a series of steps that cannot support high bonus payments and royalties until the productive potential of any basin has been demonstrated. One of the ways this can be handled is option type agreements whereby the developer would earn additional acreage at a moderate bonus cost by proving the producibility of an area. Institution of delay rentals could be deferred on all of the acreage until pilot scale development has demonstrated the economic potential of the area.

Royalties can be established on a variable scale that would minimize payments to the owner until the developer has recovered his high risk investment and would then better reward the mineral owner. Another alternative is to recognize that the coalbed methane developer must bear the investment and cost of low pressure gathering systems and compression whereas developers of traditional reservoirs generally do not. On that basis royalties can be

calculated based on a value obtained by subtracting the costs of gathering and compression from sales proceeds.

It is my understanding that the minerals in Canada are owned by the government as opposed to privately held. I do not know how that ownership relates to income and severance taxes versus royalties but if my understanding is correct, it might be possible for the government to use tax policies to reduce the developers risk without causing any loss of what are now nonexistent royalty and tax payments. That is essentially why the Section 29 credit in the US was established.

As a final comment on deals I want to remind you of my statements about the loss of productivity from coalbed methane wells when they are shut in and then restarted. This type of production requirement demands gas sales contracts that provide for continuous takes at or near their maximums throughout the year. Given the seasonality of gas markets, obtaining these kind of takes may well require the developer to sacrifice on sales price. This will significantly effect the project economics.

In closing I wish to extend my thanks for your attention and interest. I've been involved in development of this technology for nearly fifteen years now and I believe it will continue to get better as more and more people become involved. While I mentioned many problems in developing coalbed methane here in Alberta I wish you well as you start the effort to develop this resource. Thank You.



**Coalbed Methane  
Production:  
An Operator's Perspective  
Part II**

**TAURUS**

- Maturity
- Permeability
- Gas in place
- Absolute and relative perm
- Low-pressure
- Spacing
- Coproduced water

**TAURUS**

# Potential for Coalbed Methane Development

- Coal
  - Location
  - Thickness
  - Quality
  - Maturity
- Methane
  - Gas content?
  - Permeability?

**TAURUS**

## Gas Content

- Maturity
- Core recovery
- Desorption

**TAURUS**

# Permeability

- Gently folded
- Cleat spacing and size
- Insitu measurements
- Laboratory tests
- Content and permeability from core

**TAURUS**

# Location

- Identification of target area using existing data
- Identification of specific area requires significant investment

**TAURUS**

# Acreage

- Sufficient for large number of wells
- Minimum 10,000 acres for 80-acre spacing
- May require changes in leases/licenses

**TAURUS**

# Climate

- Drilling season
- Removal of coproduced water
  - Prime mover
  - Continuous maintenance

**TAURUS**

## **Gas-fired Prime Mover?**

- Methane 50% saturated
- Gas handling problems
- Weatherize wellhead equipment
- Gathering lines buried deep
- Condensation

**TAURUS**

## **Wellhead Compression and Dehydration?**

- Expensive
- Continuous maintenance

**TAURUS**

# Water Disposal?

- Mineralization
- Environmentally acceptable
- Subfreezing temperatures

**TAURUS**

# Shutdown?

- Peak market season
- Extremely adverse to performance

**TAURUS**

# Gathering and Compression

- Low wellhead pressure requires compression
  - Large gathering lines
  - Compression prior to delivery
- Higher initial investment
- Ongoing fuel expense

**TAURUS**

# Infrastructure

- Developed initially for long-term operation
  - Lease road
  - Rights-of-way
  - Gathering lines
  - Compressor stations
  - Pipelines
- Minimize long-term operating cost

**TAURUS**



## **Operating Cost**

- Higher than conventional
- 65 - 95¢ per Mcf
- Must be offset by lower finding cost

**TAURUS**

## **Finding Cost**

- Comparatively low
- In place ≠ producible
- Amortization expense

**TAURUS**

## **"Recoverable"**

- CFO and SEC vs. Engineer
- Unaccepted reservoir models

**TAURUS**

## **Economics**

- Is finding cost high?
- Picture fuzzy
- Highest gas in place offsets conservative recovery

**TAURUS**

# Solutions

- Better define actual recovery
- Improve recovery through technology

**TAURUS**

# Deal Structures

**TAURUS**

## **Nonconventional Fuels Tax Credit**

- Price floor
- Federal tax credit
- Production through 2000
- Drilled before 1/1/91

**TAURUS**

## **Deal Structures**

- Risk vs. reward
- Operator/developer, investor  
and mineral owner
- Operator's rewards must  
parallel investor's

**TAURUS**

## **Successful Project**

- Operator experienced in coalbed methane development
- Parallel risk vs. reward profiles

**TAURUS**

## **Operator/Investor vs. Mineral Owner**

- Different from conventional
- Young technology
- Make bonus and royalty payment dependent on success
- Option agreement
- Defer rentals

**TAURUS**

# Royalty

- Variable scale
  - Low at first
  - Increase at payout
- Sales proceeds minus gathering and compression cost

**TAURUS**

# Canada

- Government-owned minerals
- Tax policy to reduce risk

**TAURUS**

# **Sales Contract**

- Continuous take
- Maximum production
- Lower sales price

**TAURUS**

**TAURUS**  

---

**EXPLORATION, INC.**  

---

**AN ENERGEN COMPANY**

# COAL IN CANADA - CAN IT EQUAL SAN JUAN BASIN CBM POTENTIAL

Leslie A. Smith, P. Geol.  
LAS Energy Associates Ltd., Calgary

Coal occurs very extensively in Canada, with the bulk of the deposits occurring in the Western Canada Sedimentary Basin, as previously discussed by Gord Williams. This paper will deal primarily with these deposits in the Western Canada Sedimentary Basin. In trying to determine if similar potential as occurs in the San Juan Basin might occur up here (north is up!), I came across the following reference:

"THE EXTREMELY GASEOUS NATURE OF THE COAL AT THIS POINT, RESULTING IN A NUMBER OF SERIOUS OUTBURSTS OF GAS, HAS CAUSED IT TO BE CONSIDERED EXTREMELY EXPEDIENT TO ABANDON THIS COLLIERY FOR THE PRESENT"

In

Canada Dept. Mines Geological Survey Guidebook 9, 1913  
Transcontinental Excursion C2, Toronto to Victoria and Return  
Grande Trunk Pacific & National Transcontinental Railway

This refers to the common occurrence of face bursts caused by gas pressure within the coal seam. Surely this is an early (1913) indication that high gas contents do indeed occur in some Canadian coal seams.

Accordingly, I shall compare some Geologic factors in the San Juan Basin, where coalbed methane extraction is currently successful in several fields such as Amoco Cedar Hill (15 major wells) and Meridian 400 (35 major wells) with some of the major coal areas in Alberta to assess the potential in the Western Canada Basin.

## SAN JUAN GEOLOGY

STRATIGRAPHY Slide 1 - San Juan Stratigraphy  
The Fruitland Formation is of Late Cretaceous Age and consists of coastal plain deposits of paludal carbonaceous shales, siltstones, sandstones and COAL behind the regressive Pictured Cliffs strandline sands. The Fruitland is 30 to 200 metres thick. The coal formed in lagoons, marshes and swamps behind the strandlines, thus are elongate in occurrence parallel to the strandlines. Often the lateral development is a few miles or less. The seams are commonly thickest toward the base of the Fruitland Formation. Commonly two of the lower seams represent 60% or more of the total coal in the section.



## STRUCTURE

### Slide 2 - San Juan Structure

The structure of the San Juan Basin is a doubly plunging asymmetric syncline with the syncline axis trending in a northwest-southeast direction near the northern margin of the basin. The basin is terminated on all sides by erosion. Note the Fruitland Formation coals reach a maximum depth of 3300 to 3500 feet (1000 to 1100 m).

## PRIME COALBED METHANE AREAS

### Slide 3 - CBM GAS IN PLACE

The area of the basin with minimum of 15 BCF/section is considered the prime area. This slide shows the prime area is in the northern part of the basin and roughly equivalent to the deepest part of the syncline shown previously. This zone of high potential is very large, perhaps 50 miles by 50 miles and contains the bulk of the 50 Tcf of estimated recoverable CBM gas in the San Juan Basin. This equates to more than 2000 sections with 20 Bcf of gas per section. Quite an impressive deposit.

## STRUCTURE CONTOUR OF PICTURED CLIFFS

### Slide 4 - SCM MAP

This slide confirms the doubly plunging and the asymmetric nature of the main syncline that forms the San Juan Basin. Note the deepest part of the basin is about 3300 feet below the highest point.

The Prime area occurs at the north end, partly in the deepest part of the syncline.

## NET COAL THICKNESS

### Slide 5 - NET COAL

This map indicates there is a large area with more than 18 metres of coal with local areas containing as much as 24 metres of coal in all seams. The Prime area corresponds well with the area with the thickest coal.

Note on all three previous maps, the Prime Area also extended to the north of what you would expect to be the Prime Area given each Geologic feature. I will now show you why.

## COAL RANK

## Slide 6 - MEAN MAX Ro and COAL RANK

The 0.7 % Ro curve shows roughly the bituminous - subbituminous boundary. Note that nearly all of the prime area fits just inside the Bituminous coal area. This is to be expected, given the effects of the producible methane versus rank curves. It should be noted, however, there is a considerable area within the subbituminous areas with 5 to 15 Bcf/section, so these lower rank coals cannot be ignored.

Of great interest, however, is the large area at the north end of the basin with more than 1% mean max reflectance which roughly corresponds to medium volatile Bituminous coal. This Geothermal hot spot is related to the San Juan Batholith at the north. This area corresponds well with the Prime area and appears to provide another key to the extent of the Prime area.

## BASIN HYDROLOGY

## Slide 7 - Structural Section

Another major clue to the existence and extent of the Prime area for Coalbed Methane is Hydrology. The basin derives recharge from the outcrop areas surrounding the basin. The zones of overpressuring occur near the synclinal axis but are commonly localized in nature. The lateral shaleouts of the coal seams to the north probably contribute to the localized overpressuring conditions in this area. Another factor contributing to overpressuring is apparently a lack of permeability, thus trapping additional formation waters. The zone of overpressuring lies centrally within the Prime area.

## CBM GAS IN PLACE

## Slide 8 - Gas in Place

This slide shows the gas in place contours. Nearly half of the basin contains 5 Bcf/section or more, and the prime CBM area represents about a third of the area with +5 Bcf/section. A central zone has potential up to 36 Bcf/section. Within the Prime area, the following factors apparently have contributed to the anomalous conditions:

- <> Maximized depth of cover
- <> Maximized coal development
- <> Maximized coal rank
- <> Favorable hydrology

Other factors that contribute to favorable economics are:

- <> Excellent infrastructure
- <> A good data base
- <> Sparse population
- <> Tax incentives (\$0.84 cents per mcf)

To date, all major production that I know of occurs from within the PRIME CBM AREA. With over 1000 wells, the data base is providing better and better information.

## THE WESTERN CANADA SEDIMENTARY BASIN

Slide 9 GEOL MAP W. CAN.

Slide 10 Coal Deposits in Alberta

The Geology of the Western Canada Sedimentary Basin was well covered in Gordon's previous talk. Rather than reiterate his information, I shall look at each coal horizon in Canada and hopefully provide a comparison of the salient factors affecting CBM potential with what we have just reviewed on the CBM potential of the San Juan Basin.

**SIZE** The coal bearing region of the Western Canada Sedimentary Basin is at least 15 times larger than the San Juan Basin.

**COAL RANK** The San Juan coal rank decreases from Bituminous to Subbituminous from north to south - the WCSB coal rank decreases from Semi-anthracite to Lignite from west to east and from Kootenay to Paskapoo

**STRUCTURE** The San Juan Basin is an Assymmetric Syncline, as is the Western Canada Sedimentary Basin east of the foothills.

**HYDROLOGY** It is known that many wells have blown out from overpressured coal seams in the San Juan Basin. Here, there have been cases of rare overpressuring in coal seams, particularly the Ardley, however they are few and far between. The known pressure regime in the northern end of the San Juan has yet to be identified here.

**DATA BASE** Both San Juan and the Western Canada Sedimentary Basin have a prodigious data base. The Western Canada Basin data base is all public and therefore more accessible.

The Kootenay Formation of Jurassic Age occurs in southeast BC and southwest Alberta. It consists of a thick sequence of coal bearing rocks with prodigious coal seams within one of the middle units, the Mist Mountain. Coal seam development varies from:

- <> 76 metres in all seams at Greenhills.
- <> 48 metres on Weary Ridge.
- <> 43 metres within the Fernie Basin.
- <> 12 metres in the Coleman thrust sheet to
- <> 0 m at the erosional edge in the foothills

Coal rank varies from Semi-anthracite to High Volatile Bituminous. The aerial extent is north to the Ram River area.

## LOWER CRETACEOUS

Slide 12 Western Canada

Slide 13 Regional Cross Section

GATES/GETHING - BLAIRMORE - MANNVILLE - MEDICINE RIVER

The lower cretaceous has the most prodigious and widespread coal development of any area in Canada. Gord has provided reserves. The coals outcrop extensively in the foothills and mountains, dip deeply into the Alberta Basin and shallow slowly to outcrop in eastern Alberta and Saskatchewan. Total coal in the section are as follows:

- <> 31.4 m in Gates & Getting at Monkman, NEB.
- <> 60 m in 15 seams at Belcourt, NEB.
- <> 15 m in the Grande Cache area, Alta
- <> 13 m in one seam at Cardinal River, Alta
- <> 8 to 10 metres south of Hanna, Alta

The coal is Low to High volatile Bituminous in the foothills with a semianthracite zone along the Alberta - BC border. The rank decreases to the east to Lignite in Sask.

## Slide 14 Rank of Mannville Coals

Unfortunately the depth in the deep basin is too great for current production technology. The dashed line shows that a zone exists through southern Alberta where the rank is High Volatile Bituminous and the depth is less than 1800 metres. This zone should also prove productive. Potential exists in the foothills and mountains and in the Central Alberta area.

UPPER CRETACEOUS

Slide 15 Coal Deposits in Alta

BELLY RIVER COALS

Slide 16 Ku Table of Formations  
Slide 17 W-E Cross Section

The Belly River Coals generally occur in southern Alberta in the Oldman and Foremost Formations around Lethbridge and east to Seven Persons. These seams are generally thin (total coal less than 5 m) and discontinuous. The coal rank varies from High Volatile Bituminous to sub-bituminous. The potential is low because of the thin discontinuous seams.

HORSESHOE CANYON COALS

Slide 18 Geological Map of Alta  
Slide 19 W-E Cross Section

Horseshoe Canyon coals outcrop extensively from north of Edmonton to Sheerness. The coals are discontinuous and may be the most comparable to the discontinuous San Juan coals. They dip into the basin and outcrop to the west as the Brazeau Formation coals. The rank varies from sub-bituminous along the east side to High Volatile B Bituminous near Coalspur.

The deepest part of the basin has Horseshoe Canyon coals at a maximum depth of 1100 metres. Therefore all deep areas can be considered.

Coal development is as follows:

- 8 m south of Calgary in St Mary River Fm
- 2.3 m at Sheerness
- 2.8 m at Camrose
- 22 m in one locality of the deep basin
- 0 m in many parts of the deep Horseshoe Canyon

At the last seminar, I discounted this zone. I now think it will selectively have potential.

ARDLEY COAL ZONE

Slide 20 Ardley Map  
Slide 21 Ardley Correlation  
Slide 22 Ardley Coal Thickness  
Slide 23 W-E Cross Section

The Ardley Coal Zone of the Scollard Member and its western equivalent, the Coalspur Beds at Hinton and Coal Valley occur within a large restricted area in west central Alberta. These coal seams are extensive and laterally persistent. The ARC has extensively mapped these beds in all areas except near the outcrop zone of the Coalspur Beds. The Ardley coals thin to the south but are known to contain up to 5 metres of coal as far south as Turner Valley. In the outcrop area where major mining occurs at Wabamum there is 12 metres of coal. At Robb there is up to 34 metres of coal. In between, there are extensive areas with 12 metres or more of coal in all seams.

The rank of the Ardley varies from Subbituminous B in the Swan Hills to Subbituminous A at Wabamum to High Volatile C and B Bituminous at Coal Valley. The maximum depth varies up to 800 metres in the deepest part of the basin between Coal Valley and Wabamum.

Because this zone often has thick coal development within relatively narrow zones, and in spite of the lack of rank, this zone could conceivably have good potential. Gas flows and high pressure zones are known within these coal seams.

Now to compare these zones with the San Juan CBM Potential.

NORTHWEST TERRITORIES

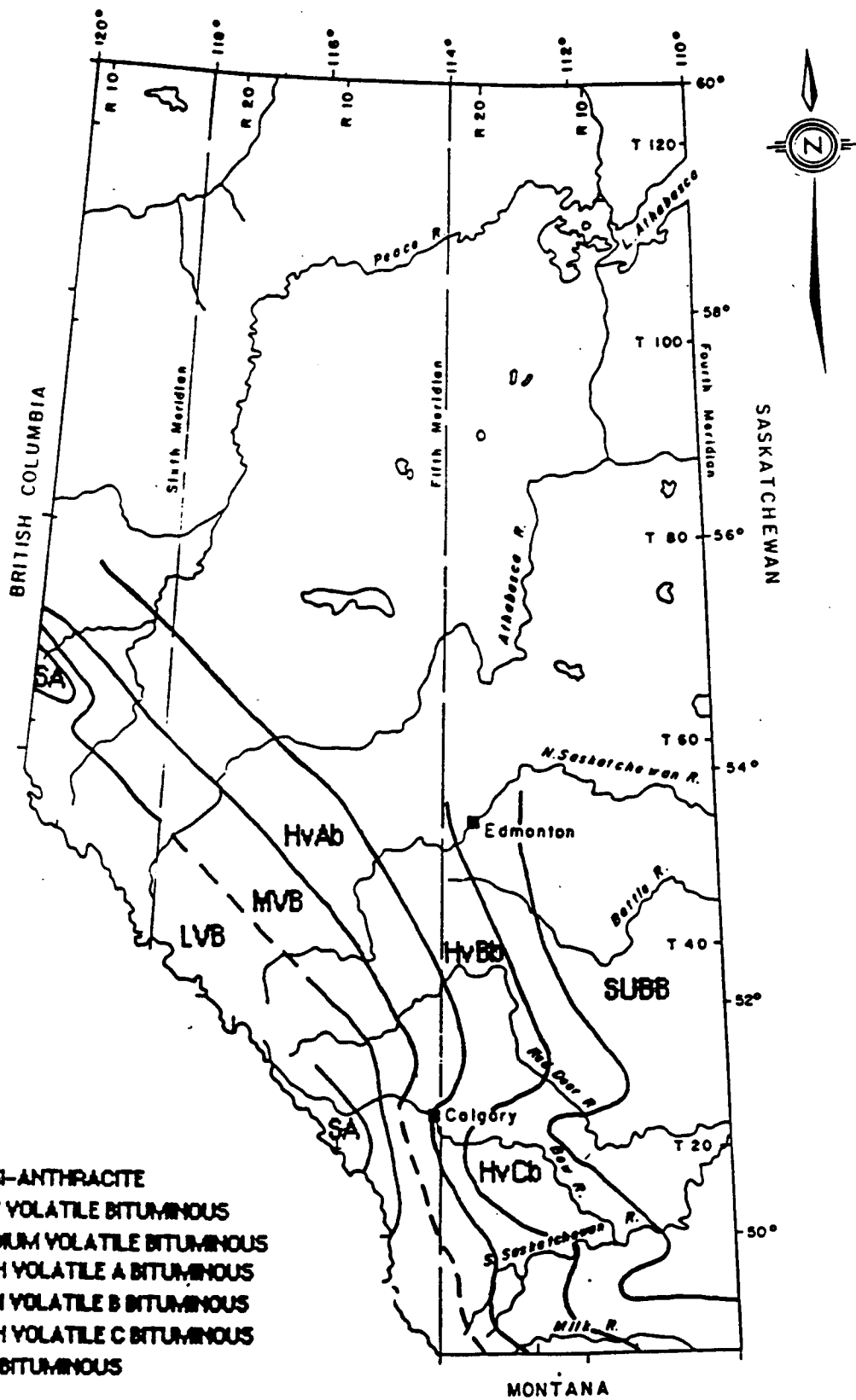

**LEGEND**

- SA SEMI-ANTHRACITE
- LVB LOW VOLATILE BITUMINOUS
- MYB MEDIUM VOLATILE BITUMINOUS
- HvAb HIGH VOLATILE A BITUMINOUS
- HvBb HIGH VOLATILE B BITUMINOUS
- HvCb HIGH VOLATILE C BITUMINOUS
- SUBB SUBBITUMINOUS

**THE RANK OF MANNVILLE  
COAL IN ALBERTA**

ALBERTA



LAS

NORTHWEST TERRITORIES

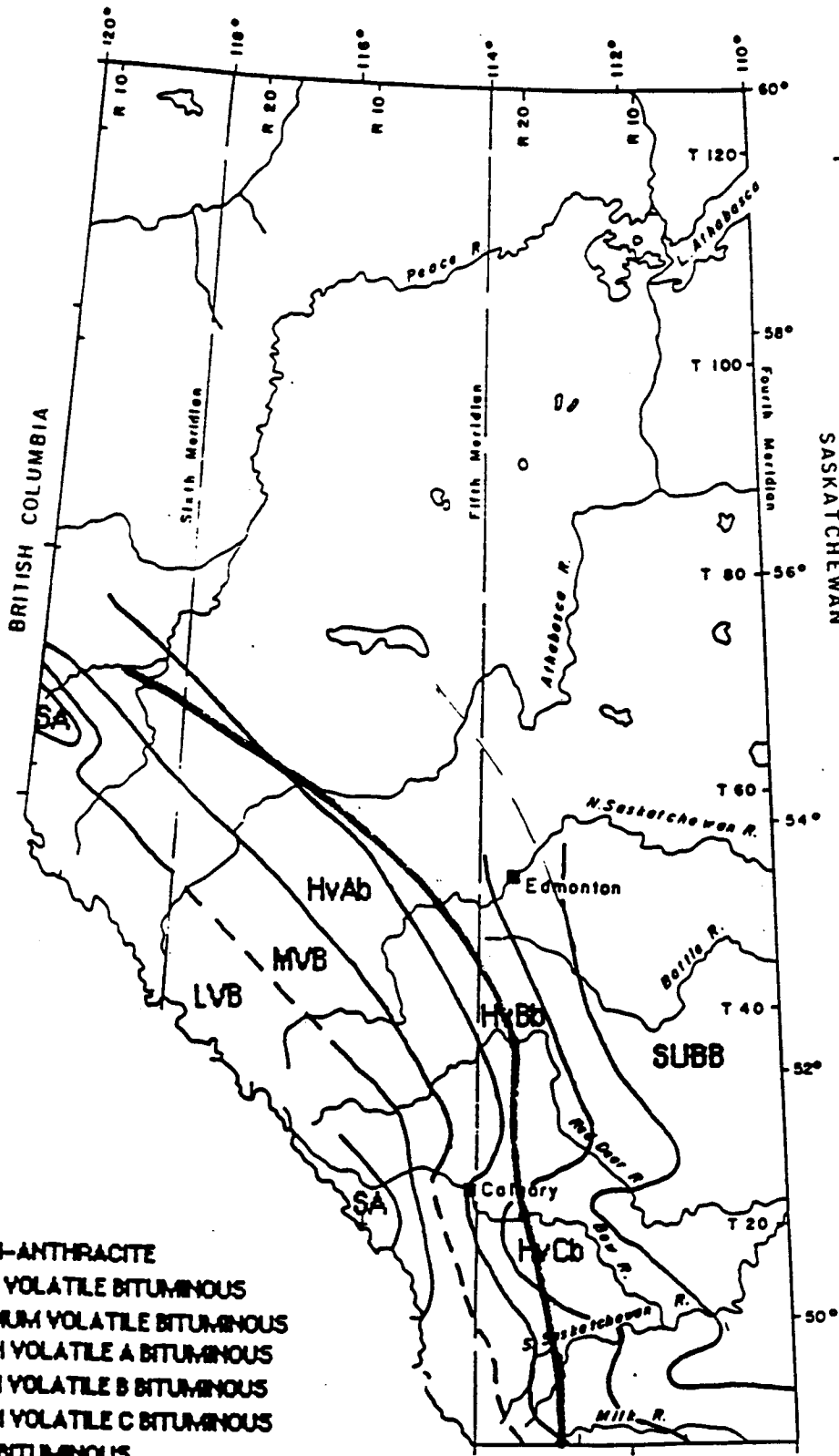

**LEGEND**

- SA SEMI-ANTHRACITE
- LVB LOW VOLATILE BITUMINOUS
- MYB MEDIUM VOLATILE BITUMINOUS
- HvAb HIGH VOLATILE A BITUMINOUS
- HvBb HIGH VOLATILE B BITUMINOUS
- HvCb HIGH VOLATILE C BITUMINOUS
- SUBB SUBBITUMINOUS

**—** 1500m. contour on top of Mannville

**THE RANK OF MANNVILLE  
COAL IN ALBERTA**

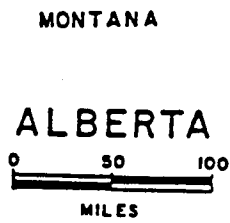



# COMPARATIVE ANALYSIS

## BASIN SIZE

BASIN SIZE  
WITH COAL  
MAJOR METHANE

SAN JUAN  
210 TWP  
30 TWP (14%)

WESTERN CANADA  
3,300 TWP

COAL DEV.

FRUITLAND

KA ARDLEY  
KHC HORSESHOE CANYON  
KBR BELLY RIVER  
KBL BLAIRMORE/ MANNVILLE  
JK KOOTENAY

**LAS**

**COMPARATIVE ANALYSIS**  
**SAN JUAN      WESTERN CANADA**

**DEPTH OF COVER**

FRUITLAND 0-1,100M	KA 0-850M
	KHC 0-1,050M
	KBR 0-1,500M
	KBL 0-3,000M
	JK 0-3,000M

**HYDROLOGY**

FRUITLAND BASINAL, SEALED	KA	BASINAL, SEAMS CONTINUOUS
	KHC	BASINAL, SEAMS DISCONT.
	KBR	BASINAL, FAULTED
	KBL	BASINAL, FAULTED, DISCONT.
	JK	FAULTED

**LAS**

# COMPARATIVE ANALYSIS

## SAN JUAN

## WESTERN CANADA

TOTAL COAL	MAX	AVG
FRUITLAND	+30 M	15 M

	MAX	AVG
KA	+30M	12M
KHC	+10M	7M
KBR	+8M	3M
KBL	+24M	15M
JK	+40M	8M

COAL RANK		SUBB	BIT
FRUITLAND		70%	30%

KA	SUBB 65%	BIT 35%
KHC	SUBB 90%	BIT 10%
KBR	SUBB 40%	BIT 60%
KBL	SUBB 50%	BIT 50%
JK	SUBB 0%	BIT 100%

**LAS**

# COMPARATIVE ANALYSIS

DO ALL ASPECTS COINCIDE FOR CBM?

## SAN JUAN

FRUITLAND YES

## WESTERN CANADA

KA YES  
KHC NO  
KBR YES  
KBL YES  
JK YES

LAS

## ECONOMIC COMPARISON

SAN JUAN (ICF)

ALTA. UPPER CRETACEOUS (MAGNATE)

### GEOLOGY

NET COAL - 11M

NET COAL - 28M

SEAMS - 2

SEAMS - 5

MED. VOL. BITUMINOUS

HIGH VOL. B BITUMINOUS

DEPTH - 810M

DEPTH - 650M

### RESERVOIR and PRODUCABILITY

MUCH DATA

VERY LIMITED DATA

4.46 BCF/WELL IN PLACE

8.50 BCF/WELL IN PLACE

3.00 BCF/WELL REC.

3.00 BCF/WELL REC.

660 MCF/DAY AT PEAK

500 MCF/DAY AT PEAK

160 ACRE SPACING

320 ACRE SPACING

LAS

# ECONOMIC COMPARISON

SAN JUAN (ICF)

ALTA, UPPER CRETACEOUS (MAGNATE)

## REVENUE

CURRENT U.S. PRICE \$2.37/MCF (1994 \$C)

## COST DATA (\$C)

\$30,000	LAND	\$12,000
\$632,000	DRILL and COMPLETE	\$560,000

## FINANCIAL (\$C)

\$0.25/MCF	TOTAL INVESTMENT	\$0.19/MCF
\$0.24/MCF	OPERATING COST	\$0.55/MCF
\$0.49/MCF	TOTAL	\$0.74/MCF
?	RATE of RETURN	31%

**LAS**

## CONCLUSION

SAN JUAN BASIN HAS: THICK COAL  
BITUMINOUS COAL  
IDEAL DEPTH OF COVER  
FAVOURABLE HYDROLOGY  
INFRASTRUCTURE IN PLACE  
OVERPRESSURING & FRACTURE PATTERNS

W.C.S.B. HAS: THICK(ER) COAL  
BITUMINOUS COAL  
SOME IS AT PROPER DEPTHS  
POTENTIALLY FAVOURABLE HYDROLOGY  
INFRASTRUCTURE  
POTENTIAL FOR OVERPRESSURING  
POTENTIAL FOR FRACTURE PATTERNS

--BUT--

TO FIND A MAJOR CBM GAS FIELD  
NEED ALL OR MOST MAJOR REQUIREMENTS SIMULTANIOUSLY

**LAS**

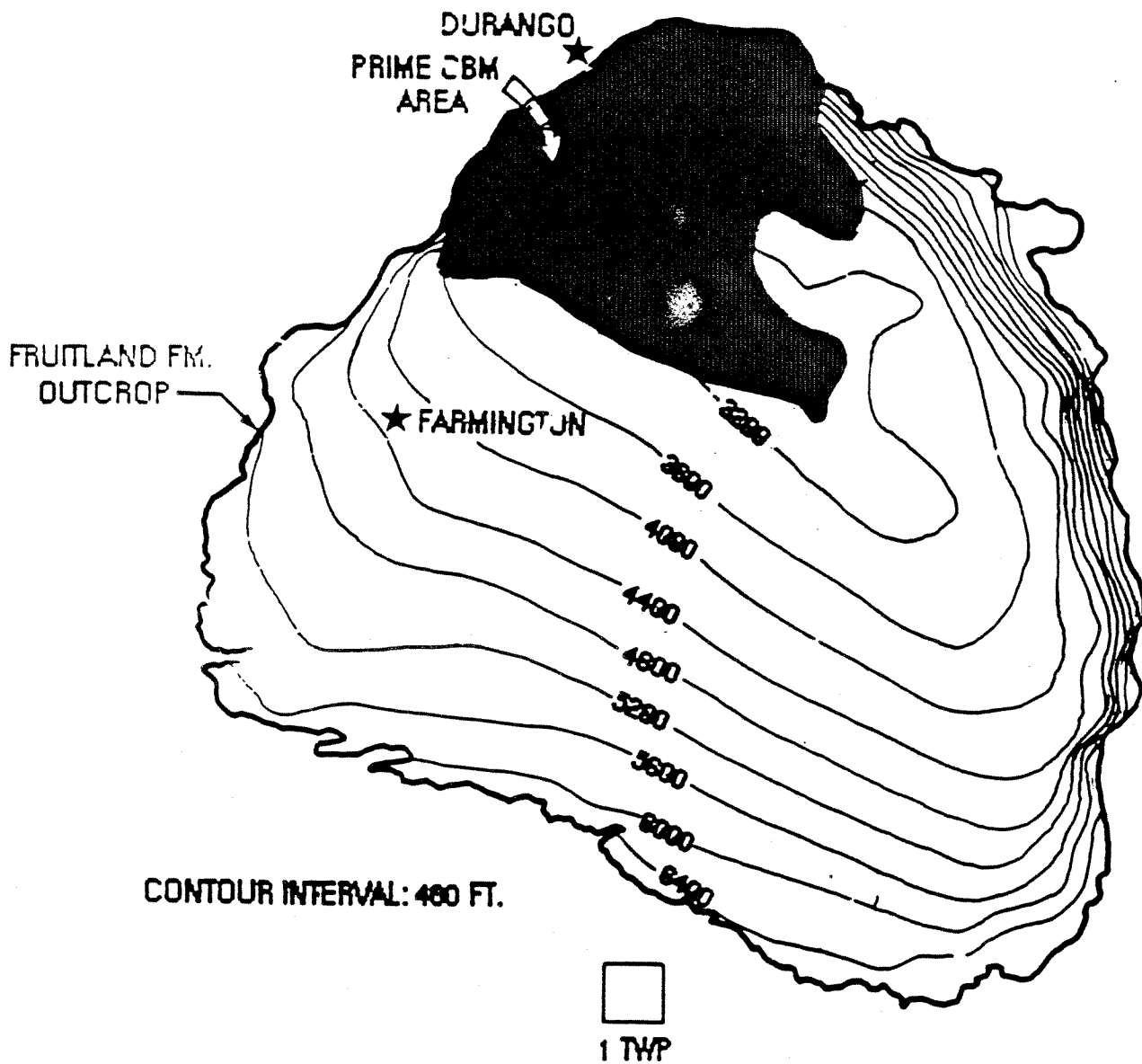

SAN JUAN BASIN  
STRUCTURE CONTOUR OF  
PICTURED CLIFFS SANDSTONE

LAS



WEST

EAST

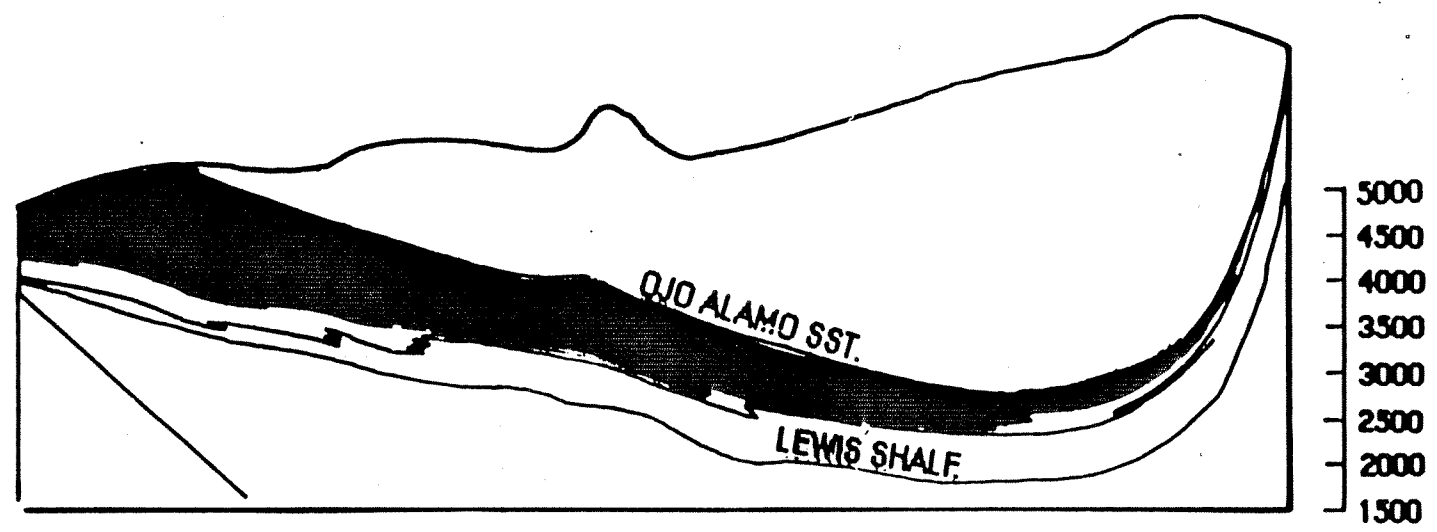

SAN JUAN BASIN STRUCTURAL SECTION

LAS

WEST

EAST

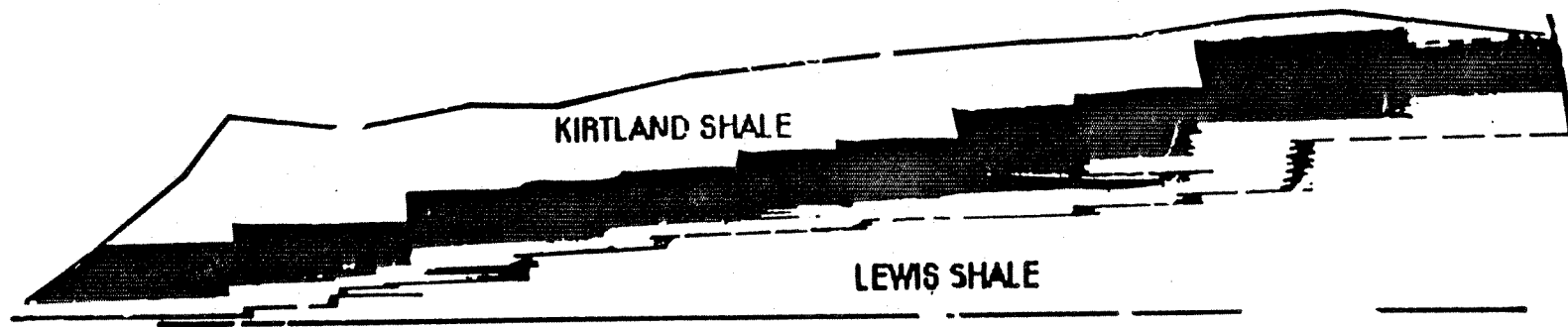

# SAN JUAN STRATIGRAPHY

LAS

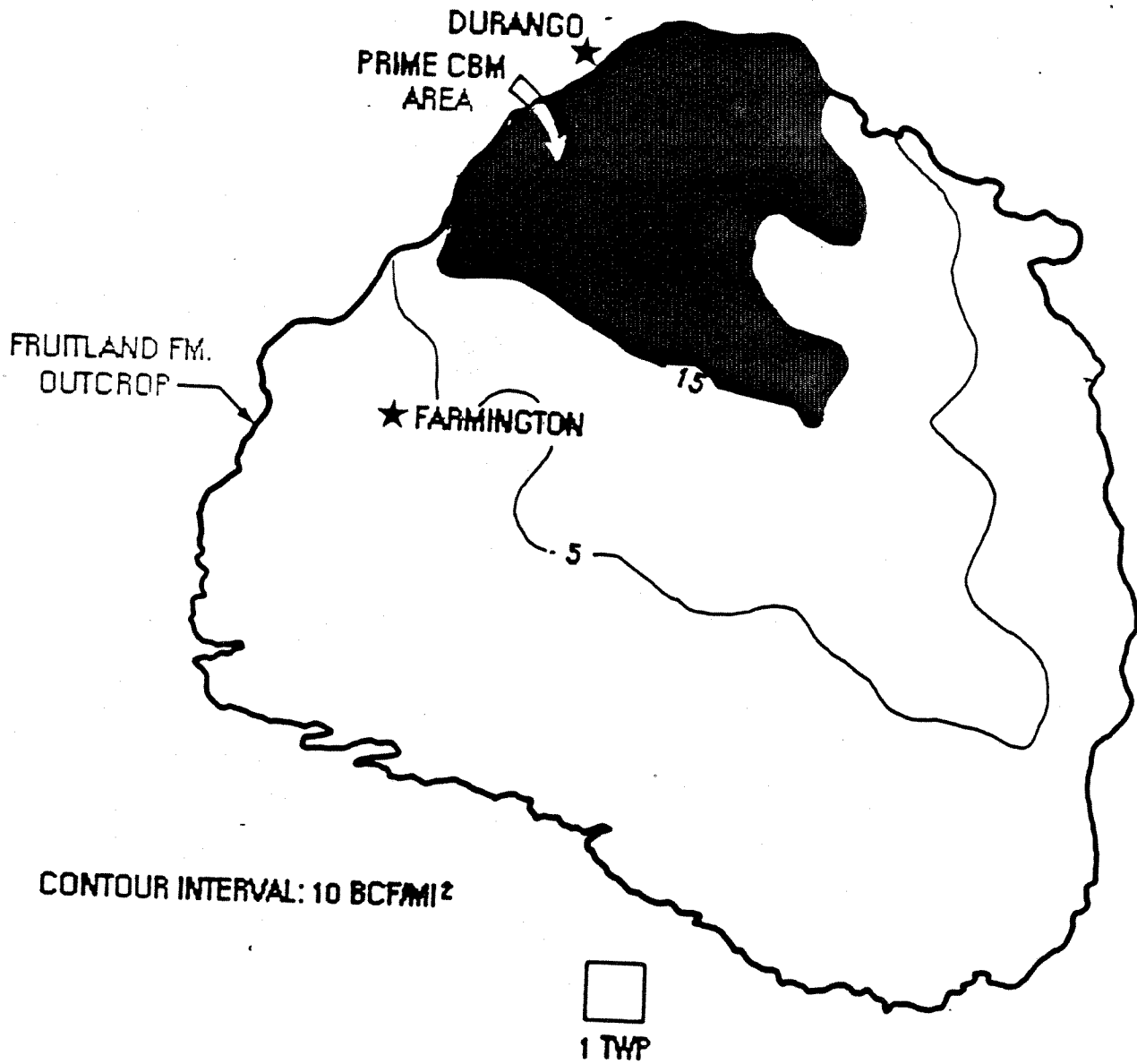

# SAN JUAN BASIN GAS IN PLACE CONTOUR MAP

LAS

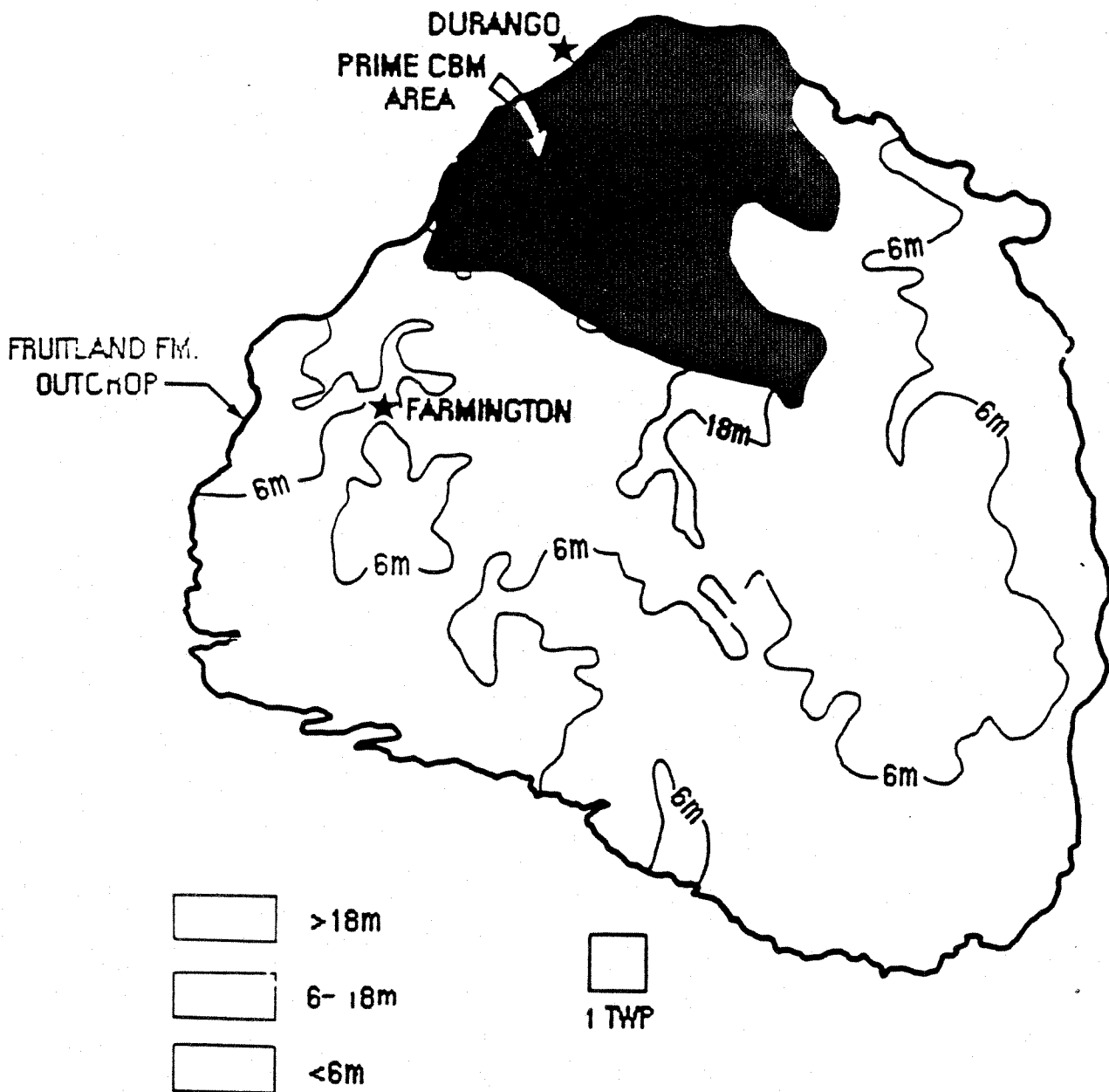

**SAN JUAN BASIN  
NET COAL THICKNESS ISOPACH**

**LAS**

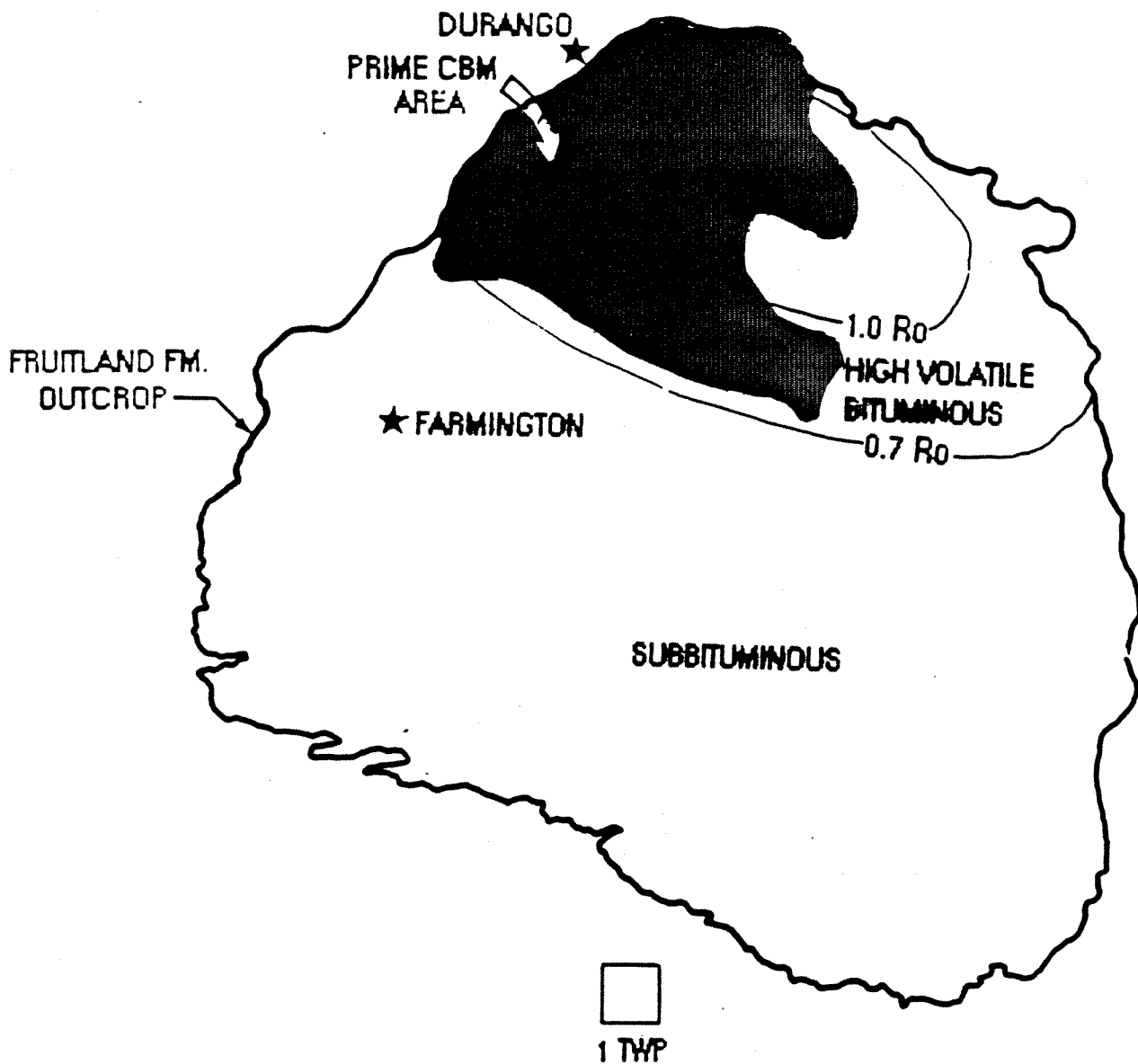

**SAN JUAN BASIN  
MEAN MAX Ro & COAL RANK**

**LAS**

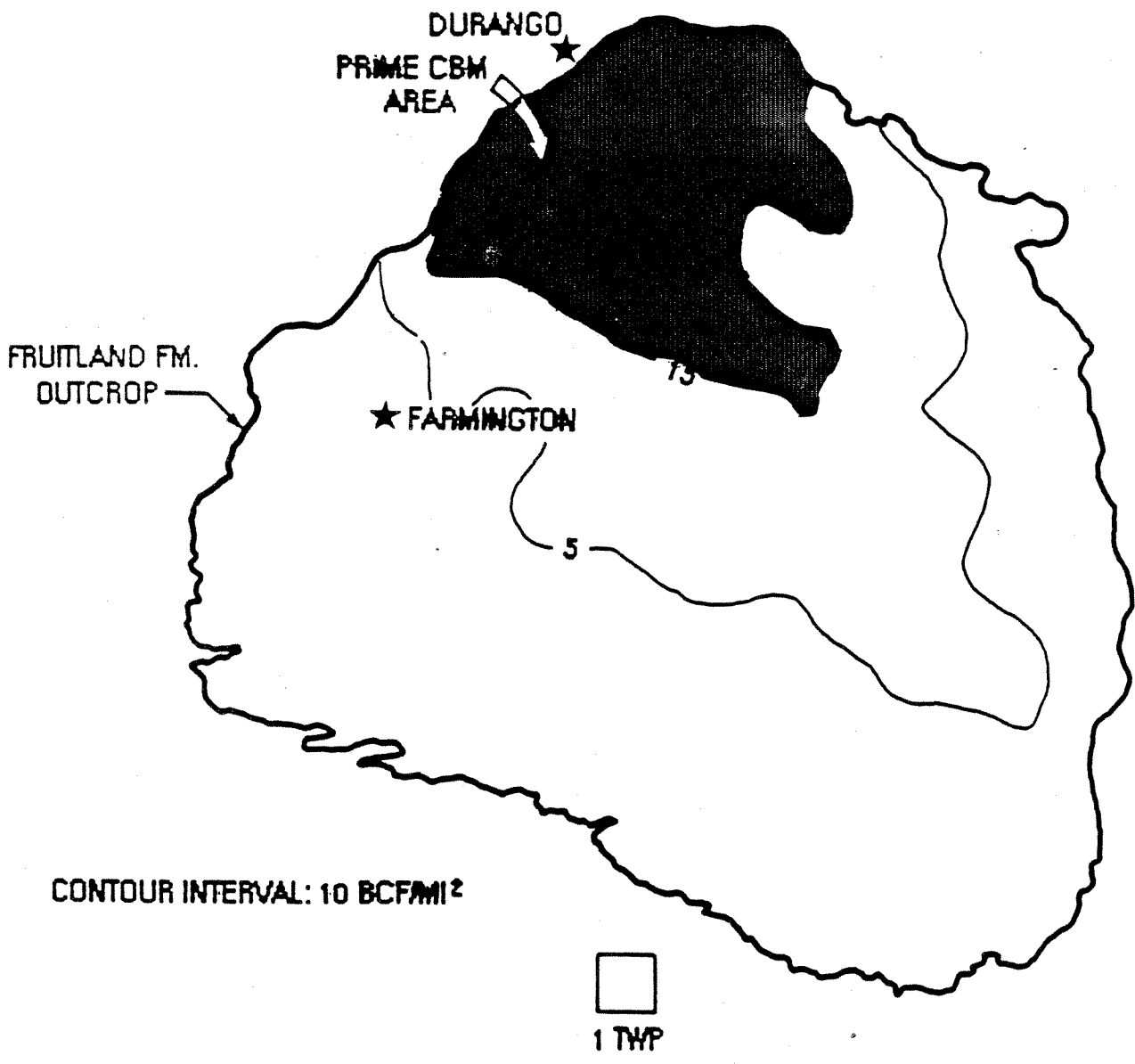

# SAN JUAN BASIN GAS IN PLACE CONTOUR MAP

LAS

**Coal Demethanation Talk  
to be Given to the**

**Coal Demethanation Seminar**

**Sponsored by the  
Alberta Research Council**

**HISTORY AND EXPERIENCE OF CANADIAN COMPANIES  
IN COAL DEMETHANATION**

**PRESENTED BY**

**A. A. KAHIL  
CANTECK CONSULTING LTD.**

The first serious attempt in Canada to extract methane from coal to obtain a fuel was started by a company called Alberta Gas Transmission Ltd, which has since changed its name to Nova, an Alberta corporation. Nova's main business at the time was the transmission of gas in the Province of Alberta. Because it was thought in the early 70's that the reserves of gas in Alberta were becoming scarce, Nova began looking for alternate sources of gas to keep its pipelines utilized. It began to put its plans together in 1974. A series of arrangements with other companies to develop the technology fell through and Nova finally settled on developing the technology on its own using staff and consultants. The basic team was built around

1. Alain Kahil managed the department. He is a geologist who had worked in the oil and gas industry with one of the majors, had managed a coal exploration group for a major oil company in Calgary, and had worked on a Ph.D. in hydrogeology.

2. Denes Masszi, a geophysical engineer with a Ph.D. in mining engineer. He has considerable experience in methane extraction in Hungary and had managed the geophysical department of a large coal mining complex, and

3. Sproule and Associates, led by Mr. Rudolph Cech, who brought the oil and gas technology and field operation experience.

This team, as can be seen, supplied know how and experience in each of the technologies which contribute to the methane drainage technology. Viz., petroleum, coal and hydrogeology. It also brought considerable drilling and field experience from the different technical fields. The Nova team eventually developed into a 16 member group with two offices, one in Calgary and one in Halifax, Nova Scotia.

In 1987, through a management buy-out, the methane extraction department of Nova was purchased by CANTECK Consulting Ltd. which was formed by most of the department's employees. CANTECK was formed to continue consulting in coal demethanation. The Principals of CANTECK presently consist of Alain Kahil, Denes Masszi and Mike Rushton (in our Halifax office). CANTECK now owns all of the files and the technology developed by Nova.

A team, composed of CANTECK, Sproule and Associates (which you are already familiar with), Sumus Resources Evaluations Limited, supplying coal geology expertise) and R. Porteus Engineering (?) (supplying fracing expertise) has been



formed to supply technical services in the field of gas extraction from coal. The Alberta Research Council, has also agreed to work in association with us to supply a complete one stop coal demethanation service. This group can be drawn upon to supply any size of service.

Nova's initial plan was to assess the coalgas reserves in Alberta and test various promising sites in Alberta for methane drainage while developing the technology. This approach would also allow it to obtain experience in a variety of geologic environments. Thus, it initially undertook projects in three different parts of Alberta. These three areas were Canmore, Sullivan, and Coleman areas.

The Alberta operation had as its goal to develop the technology but not necessarily to develop production. Therefore several experiments were tried on the wells that were drilled. Once the results of a certain experiment were assessed, something new would be tried. In this way a particular well became a test site for a large number of experiments. As a result of the Alberta experience, a methane extraction technology was developed which was referred to as Virgin Coal Demethanation or VCD for short. This terminology was used to differentiate it from methane drainage which is the technology used in coal mines to extract methane from the coal principally for mining purposes. The differentiation is very useful and will become more useful as oil companies become more involved in coal demethanation.

Most oil companies, in getting involved in methane derived from coal, only consider the technology of extracting the methane from coals using boreholes with a major vertical component and essentially drilled from the ground surface. This is an understandable bias because they are more familiar and at home with many of the tools used in that technology. However I would strongly recommend that they review the whole potential of obtaining methane from coal, and not ignore the possibility of obtaining gas from mines. This gas is generally much cheaper to extract and can be present in very large quantities. For example, one of the principals of CANTECK consulting is a 50% owner in about 2.5 million cu ft of methane being extracted daily from only one of the DEVCO mines in Cape Breton, Nova Scotia. Occidental Petroleum is extracting 45 million cu. ft. per day of methane from its mines (operated by the subsidiary Island Creek) in West Virginia. In that particular case the production rate can be increased by another 40%. As companies get more involved in methane extraction from mines, the terminology to differentiate the various extraction techniques will become important as the two have fundamental differences in extraction techniques and produce a slightly different product. Let me clarify the terminology I will use in the remainder of the talk.

VCD means the technology of extracting methane from coal essentially independently of a mine,

methane drainage means the technology extracting of methane from a mine,

CBM means methane derived from coal, and

methane extraction is used as a general term for the removal of methane from coal by any technique.

Although the methane drainage technology has been in existence for over 50 years, it has continually been developed and made more efficient. We have devoted part of our energy when at Nova to perfecting the system to increase its efficiency; that is, to increase the capture ratio between the methane collected and that lost, to reduce the cost, and to maximize the methane concentration of the captured gas.

At about the same time that Nova began its methane drainage development, the US Bureau of Mines was developing its VCD technology under the leadership of Maurice Duel. Thus the two organizations began an ongoing discussion comparing experiences and sharing ideas.

## 2.0 ALBERTA PROJECT

The Alberta project was divided into three components;

1. Theoretical Studies.
2. the Foothills study and
3. the Plains study

### 2.1 Theoretical Studies

A considerable amount of work was done to establish a valid theoretical background to the work that was going on in the field. A list of tasks in literature research and comparisons studies were initiated.

Later in the program a study was commissioned at the University of Calgary chemistry department to study the coal/gas system. This involved a library research to learn all that had been published, followed by a study to determine what effect each of a number of conditions which define a steady state for gas adsorbed on coal, had when it was changed. The purpose of this work was to find out what was the most efficient way of disturbing the equilibrium in the coal/gas system and thus get the maximum methane production from a well.

At the same time work was being undertaken at the University of Manitoba in the Engineering department to study fracture propagation in coals. This work was undertaken to understand and maximize the efficiency of frac systems for VCD well stimulation.

## 2.2 Foothills Study

### 2.2.1 Technical considerations

As mentioned above three study sites were selected. In the initial work all three sites were used. In subsequent phases only work in the Canmore site was pursued. In the Canmore site an initial 5 VCD wells were drilled. In the Sullivan site one VCD well was drilled, and in the Coleman site two VCD wells were drilled. Of the five Canmore wells, three were what would now be considered classical demethanation wells. Two were wells that drained the old mine workings, and one was a slant hole that started in the coal outcrop and continued in the coal during its whole length.

A second series of hole was drilled in the Canmore area. These were designed to, in part, prove that shallow VCD wells could be commercially viable. Several drilling techniques were tested in the Alberta program including the rotary, down-hole hammer, normal and revers circulation systems. Also several drilling fluid were experimented with to reduce damage to the natural permeability of the coal. These included water, standard, mud biodegradable muds, foam, and air.

A number of borehole logs were also tested to determine which gave the most useful information for coal demethanation.

Different completion techniques were also tried including:

- a. Open hole completion,
- b. Casing with perforations,
- c. Casing with machined slots,
- d. Casing with a number of different liners,
- e. Casing with a gravel pack, and
- f. multiple seam completion techniques.

One of the most fundamental general conclusion derived from all this work was that one has to match the techniques one uses to the local conditions. That is, there is no inherently correct method that works everywhere. Obviously there are techniques that don't work anywhere but not the reverse.

The stimulation methods were considered very important to increase production to economic levels. Consequently a considerable effort was expended to gather hydrogeologic parameters of the coal. A hydrogeologic consultant was employed to study the permeability of the wells. I believe that we were the first company to use injection tests to determine permeability instead of pump tests which cause the gas to desorb and therefore give one th wrong permeability. Several observation wells were drilled around production wells to measure water levels and obtain a measure of the anisotropy of the coal. Those wells were also used to measure gas pressure and determine where production was coming from and how far the effect of a well extended to determine well spacing.

The hydrogeologic studies allowed us to asses the amount of water to expect to have to produce and thus to gauge the size of pump required.

The hydrogeologic work also allowed us to be the first to propose that VCD wells are more efficient if the cones of depression of the water resulting from the pumping of the water interfered with adjoining wells. This is now considered standard practice. This concept also then specifies that a number of VCD wells are much more efficient than a single well.

Hydrofracing was the principal stimulation method used and several different techniques and injection fluids were tried. For example we injected water, nitrogen foam, and ethonol all with and without proppant. We even tried a Kiel frac on one of the wells.

The second series of Canmore wells used as a test site for the cavity stress stimulation system which was invented by one of the principals of CANTECK and has been patented in 14 countries. This stimulation system uses a cavity in the coal to destress the coal and in so doing to break up the coal and open up the fractures in it. Thus, as opposed to the frac which breaks up the coal, increases the overall stress in the coal and injects a material which may coat the coal and thus reduce the methane production, the cavity stress method destresses the area and breaks up the coal to produce a very large surface area. This increases the production rate of the coal. Fracing also produces fines which plug up the screens and damage the pumps.

An article was published on the cavity stress relief method in the Unconventional Gas Recovery Symposium proceedings as SPE 12843. A reference to it is made in the 6th article on coal demethanation recently published by the oil and Gas Journal. Unfortunately the authors are listed as Alain A.K. and Denes D.M. instead of our proper names.

Pumps are a high maintenance item, and their proper choice is an important factor in the cost of operating a well. Because shutting in a VCD usually irrevocably reduces the efficiency of the well and reduces its output, a pump that needs constant maintenance will have a negative effect on the well production. We operated a variety of pumps throughout our work (that is not only during the Alberta project) They included submersibles, horsehead, and gas lift pumps.

## 2.2.2 LEGAL CONSIDERATIONS

When work started in VCD development there was no legal framework to accommodate the work. The work was done under a special research permit and has therefore not established legal precedent in Alberta.

During the work, numerous discussions took place with the ERCB in order to establish some standards in VCD for the equivalent of "good engineering practice" that applies to the development of petroleum wells. The definitions were never codified, however the discussions helped the ERCB understand the technology. Any future work, especially when it begins to involve commercial development, will require discussions with the regulatory bodies in Alberta. This is something that we could assist in.

## 2.3 Plains Study

The Plains study was undertaken to establish the gas reserves in the coal in the Alberta Plains. It made use of the wells that were being drilled by oil companies. The sites of interest were selected and whenever a well was announced for an area of interest, the company drilling the hole would be contacted and an agreement would be entered into which would allow us to get a sidewall core of the coal. The methane content of the sample would then be measured, and the coal would be tested in the lab for whatever other measurements were needed. samples were collected at depths that ranged between 2,000 and 4,500 ft. This information has never been published.

## 3.0 Nova Scotia

The coal demethanation work in Nova Scotia involved two studies:

1. Methane drainage in the DEVCO mines
2. VCD work in the other coalfields of Nova Scotia.

## 3.1 Methane Drainage Project

In 1981 we began Phase 1 of a project to extract and sell methane from the coal mines operated by DEVCO. The Phase 1 was a feasibility project and technology optimization. This involved the refinement of methane drainage techniques for the conditions in the No. 26, and Lingan mines. The work included collecting methane from the active face, the coal that is to be mined in the future, the coal seams above and below the workings, as well as the methane being generated in the sealed off old workings. The study was completed by 1983 and indicated that the project was economically viable using the techniques developed. A system to bring the methane to the surface was designed and installed. This system is now producing 2.5 million cu ft of methane per day and has been for the last 5 years. Because of a variety of reasons, mostly involving a fire in one of the mines and provincial and Federal politics, a methane drainage system was not installed in the other mines and the methane is not being used, but is being vented.

### 3.2 VCD Project

#### 3.2.1 Project purpose

The VCD project first involved the testing of all of the coalfields of Nova Scotia to determine their potential for methane extraction. About 27 wells were drilled in this phase of the program. From the result of the work it was decided to concentrate on the Pictou field. In total 7 wells were drilled to optimize the techniques for the local conditions. The project was put on hold in 1983 because of the very low energy prices.

#### 3.2.2 Technical considerations

The cost of drilling a VCD well is often one third of the cost of the completed well. Because geology plays an important part in the economic viability of VCD and geologic structure in most of the Nova Scotia coalfield is complex, it was recognized that if a decision could be made regarding the viability of a well just after it was drilled but before it was completed then essentially three unviable wells could be drilled for the price of one completed well. A method was thus developed using a calibrated mud log to assess the viability of wells as they were drilled. With this system a measure of the gas content of the coal and the rate of desorption of the coal could be determined. Although not completely accurate this information is very important in designing wells completions. This was proven in New Zealand a few years later when completion costs of the wells we installed there were considerably reduced over the normally anticipated costs.

#### 3.2.3 Legal Considerations

Because of our work, Nova Scotia has the most developed legal framework for coal demethanation in Canada. The government decided to set up a separate category for coal methane for which a company can file. Although some precedents have been set which can be used as a guide for future work, there still is considerable clarification that is required. The Nova Scotia government has been relatively reasonable in its approach to the regulations regarding technical matters, but is inclined to get an inordinate amount of politics involved in its decisions.

#### **4.0 Vancouver Island Project**

##### **4.1 Project purpose**

This project was intended to be a commercial project to supply gas on Vancouver Island where there did not exist an indigenous source of gas.

##### **4.2 Technical**

We started by investigating the gas content of coal in various coalfields on the island and ended concentrating on the Nanaimo field.

One VCD well was drilled in the Island but was never tested because the controversy regarding the pipeline made the development of an indigenous gas source unacceptable to the provincial government of the day.

The project has passed on to a local land owner who has not developed it. I believe because of lack of funds.

##### **4.3 Legal**

No precedent has been established in British Columbia as a result of our work, although the B.C. Government has indicated that the CBM rights go with the petroleum licence.

#### **5.0 International Consulting**

In 1983 we went into international consulting and ended up having projects in New Zealand, Hungary, Turkey, China, and Canada. The department was so successful that it received an export award from Alberta.

#### **6.0 Summation**

There is a considerable amount of work has been undertaken in Canada in the field of VCD however there are no commercial project underway at this time. For a new technology to develop it needs very favorable circumstance to absorb the inefficiencies inherent in a new technology while it is being developed. In the U.S., the favorable

circumstances were provided by the coal mines that had to spend considerable sums to get rid of the methane to continue with their primary purpose, that of mining coal. Thus Jim Walter Resources and US steel could afford finance the development of the methane extraction even through its uneconomic beginnings. Also the U.S. economy sheltered the producer from the very low energy costs, so that Jim Walter Resources could sell its gas at a considerable greater cost than was possible in Canada. At this time there are no commercial VCD projects in Canada. The principal reasons for this are as follows:

1. The only gassy coal mine that requires methane extraction extends under the ocean and therefore it is not possible to use the VCD technique to drain the coal ahead of the mining.

2. Other underground coal mines which have gas in their coal are in Alberta where there has historically been a considerable amount of shut-in gas.

3. The price crash of the early 1980s was maintained for too long to allow companies that had faith in coal derived methane such as Nova to continue working in anticipation of a price increase.

In spite of the conditions mentioned above we were always so close to economic viability that Nova continued to develop the system expecting a commercial project as soon as fuel prices increased only slightly. This condition seems to be at hand now.

A big impediment to the development of a commercial VCD program at the time has now been removed. The gas bubble which, in Canada was centered in Alberta, shows signs of disappearing. The area that is the prospective for VCD production is in the Alberta mountains and foothills or in nearby British Columbia.

Now that the gas bubble seems to be either disappearing, or at least becoming smaller, and the price of gas may be rising, the conditions are greatly improved and Canada may soon see a commercial VCD project.



**AN OVERVIEW OF  
ALBERTAN & CANADIAN  
DEMETHANATION EXPERIENCE,  
TECHNOLOGY ADVANCES  
AND  
DEVELOPMENT POTENTIAL**

Presented at:

**"COAL BED METHANE IN ALBERTA - WHAT'S IT ALL ABOUT"**  
the first Technology Transfer Series Seminar

Sponsored by the Alberta Research Council  
and the Alberta Geological Survey

Calgary Convention Centre, Jan. 30-31, 1990

By:

**PETER J. PROUDLOCK**

President

CH4 International Ltd.  
808 - 48 Street N.E.  
Calgary, Alberta, Canada  
T2A 4L9

1 (403) 273-6296

AN OVERVIEW OF ALBERTAN & CANADIAN DEMETHANATION EXPERIENCE,  
TECHNOLOGY ADVANCES AND DEVELOPMENT POTENTIAL

Page I

=====

TABLE OF CONTENTS

<u>SECTION</u>	<u>PAGE NO.</u>
1. INTRODUCTION	1
2. ALBERTAN & CANADIAN DEMETHANATION EXPERIENCE	1
3. CANADIAN COAL BED METHANE RESOURCES	3
4. EVALUATION OF COAL GAS RESOURCES	8
5. ALBERTAN & CANADIAN DEMETHANATION TECHNOLOGY	8
5.1 Drilling	9
5.2 Sampling	9
5.3 Early Evaluation While Drilling	15
5.4 Geophysical Well Logging	16
5.5 Stimulation Methods	18
5.6 Completions and Pumping Systems	20
5.7 Well Operations	20
5.8 Communication and Environmental Awareness	22
6. SUMMARY	22
7. FOOTNOTES	23

<u>FIGURES</u>	<u>PAGE NO.</u>
1 Distribution of Coal in Canada - Map	4
2 Estimated Canadian Coal Gas Resources in Movable Coal Table	5
3 Methane Adsorption on Coal with Rank & Depth - Graph	6
4 Coal Mine Drainage Systems	10
5 Coal Gas Measurement Apparatus	12
6 Desorption Data and Calculations - Sample Sheet	13
7 Desorbed Coal Gas - Graph	14
8 Calibrated Coal Density v/s Conventional Density Logs	17
9 Demethanation Well Design	21

AN OVERVIEW OF ALBERTAN & CANADIAN DEMETHANATION EXPERIENCE,  
TECHNOLOGY ADVANCES AND DEVELOPMENT POTENTIAL

Page 1

=====

1. INTRODUCTION

The subject of this paper: "An Overview of Albertan and Canadian Demethanation Experience, Technology Advances and Development Potential" is somewhat new, or unexpected to most in that all too often people and companies are unaware a) of the potential of coal gas, b) that the technology exists in Alberta, let alone Canada, and c) that demethanation started in Alberta over a decade ago. A few of us here in Alberta have been preaching the virtues of coal gas to the faithful for a good number of years, and like any true evangelist, I am only too happy to have a whole new congregation of converts who have recently become aware of coal gas and its potential. So let me tell you something about this resource in Alberta and Canada, and mention some of what has been learned and the technology connected with it.

2. ALBERTAN & CANADIAN DEMETHANATION EXPERIENCE

The study of Alberta's, and Canada's coal gas development potential started at least as early as 1974. The work that was undertaken in Alberta was initially buoyed by the U.S.D.O.E. thrust of research. Since that time coal gas research and development in Alberta has advanced appreciably in many areas.

During this early period one project that was undertaken was one in which sixteen experimental coal gas research wells were installed and operated for a number of years.<sup>1</sup> I worked directly on this project, gaining invaluable hands-on field experience, and helping to marry mining and coal drilling methods with more conventional petroleum technology. In this project many novel drilling, completion, stimulation, pumping and well maintenance methods were tried, developed and modified. Two well groupings were put in to assist in determining the multi-well effect. With multi-well groupings, the area between wells dries and the desorption rate increases due to the lowering of both the reservoir pressure and the critical moisture. I might mention, that the water quality of these wells was excellent, and disposal was not a problem.

Other projects involved the measuring of the coal gas content of many Canadian coals, such as the Alberta mountains, foothills and plains, Nova Scotia basins, Cape Breton and Vancouver Island. Gas contents in the mountains of 15 cc/g at shallow depths to over 20 cc/g at moderate depths were measured. It was found that the highest values are in the higher rank coals, not in medium volatile bituminous, which has been noted<sup>2</sup> to contain the higher values in the Piceance Basin of Colorado. Gas contents on the Plains range from almost zip to over 10 cc/g. Nova Scotia coals are about 6 to 10 cc/g and Vancouver Island is similar to a bit higher.

AN OVERVIEW OF ALBERTAN & CANADIAN DEMETHANATION EXPERIENCE,  
TECHNOLOGY ADVANCES AND DEVELOPMENT POTENTIAL

Page 2

=====

Additional work involved evaluating the safety of a subdivision located over old coal mines, and the potential of co-production of both conventional natural gas and coal bed methane from a single well, which show excellent potential in the mountains. Academic research has included such things as: evaluation of methane drainage in Canadian mines, gas sorption and desorption, effects of particle size and moisture content, electron microprobe work, stimulation design and, recently, improved sampling and well evaluation methods. Canadian, and especially Albertan, experience has been varied and extensive.

Knowledge gained from Alberta based research has been applied in other areas in Canada, as well as internationally. In Canada, outside of Alberta, four wells and an underground methane drainage system were installed and operated in Nova Scotia and one well was drilled on Vancouver Island. Extensive drilling for evaluation was done in Nova Scotia and Vancouver Island. Internationally, wells were installed in New Zealand and in Hungary, and work was carried out in a number of other countries.

Since a number of people interested in producing coal gas are from the coal mining industry, I mention that both surface demethanation wells and underground coal mine drainage systems can be used to extract coal gas. The coal mine drainage systems include in-seam drainage, cross measure drainage, gob drainage and underground virgin coal drainage. The coal industry in Canada exhausts about 500 million cubic metres of coal bed methane into the atmosphere annually<sup>3</sup>. About half of this is estimated to be capturable. Methane capture from mining operations can be profitable, and the coal industry may, in the future, be required to capture methane to reduce atmospheric emissions. About 5 to 10 years lead time before mining is required to optimize capture from either the surface or underground, but some post mining methods also apply. Therefore, the Canadian coal mining industry should be looking much more seriously into coal bed methane.

=====

3. CANADIAN COAL BED METHANE RESOURCES

CH4 International Ltd., in a 1989 study<sup>4</sup>, has made the first detailed estimate of Canadian coal gas resources. This was predicated on recent work by the G.S.C., since published, which gave a new estimate of Canadian coal resources. As the map<sup>5</sup> in Figure 1 clearly shows, Alberta is richly endowed with coal of excellent rank.

The table<sup>6</sup> in Figure 2 shows a conservative estimate of the potential coal gas resources in Canada, in coal of economic interest alone, at 2.0 trillion cubic metres (70 trillion cubic feet). 25% of this coal gas is in coals of immediate interest (for mining). We know the coal gas is there in the ground - it is just a matter of measuring and producing it.

Arguments can be made that the ultimate total gas in place is at least three times as large, and as much as ten times, when all Canadian coal in place is considered. CH4 International is currently refining this estimate. This is an extremely significant amount of gas, and much of this is in Alberta. The ultimate amount of 20 trillion cubic metres (700 trillion cubic feet) is more than three times the estimated ultimate quantity of recoverable conventional natural gas (5.7 trillion cubic metres), of which only half is as yet undiscovered.

While coal gas may not in some instances be as inexpensive to produce as some local conventional natural gas sources, it is certainly less expensive than large pipeline projects bringing distant conventional natural gas to market. Coal gas can be produced from wells of any depth, ranging from very shallow to the deepest. As shown by the graph of coal gas content with rank and depth<sup>7</sup> (Figure 3), the gas content increases rapidly with shallow depths and less rapidly at greater depths, and also, the higher the rank the greater the initial increase in gas content. This graph shows a theoretical gas content. It is based on measurements taken from a number of U.S. coals some years ago. The model says nothing of production rates: porosity and permeability are not addressed. The highest rank coals tend to be tighter.

Alberta coal contains about 5 to 20 cubic metres per tonne, which content is dependent mainly on rank and depth. 10 cubic metres per tonne is considered very good and 15 is excellent. Alberta Mountains coals contain very high amounts of gas, especially at depth, where values well over 20 cubic metres per tonne are found. The predominant rank of Alberta Mountains coals is low volatile bituminous. In other Alberta areas coal gas is also a very significant resource, and is already, under certain conditions, being produced as conventional natural gas; in fact the huge Elmworth natural gas field is, in large, sourced by coal<sup>8</sup>.

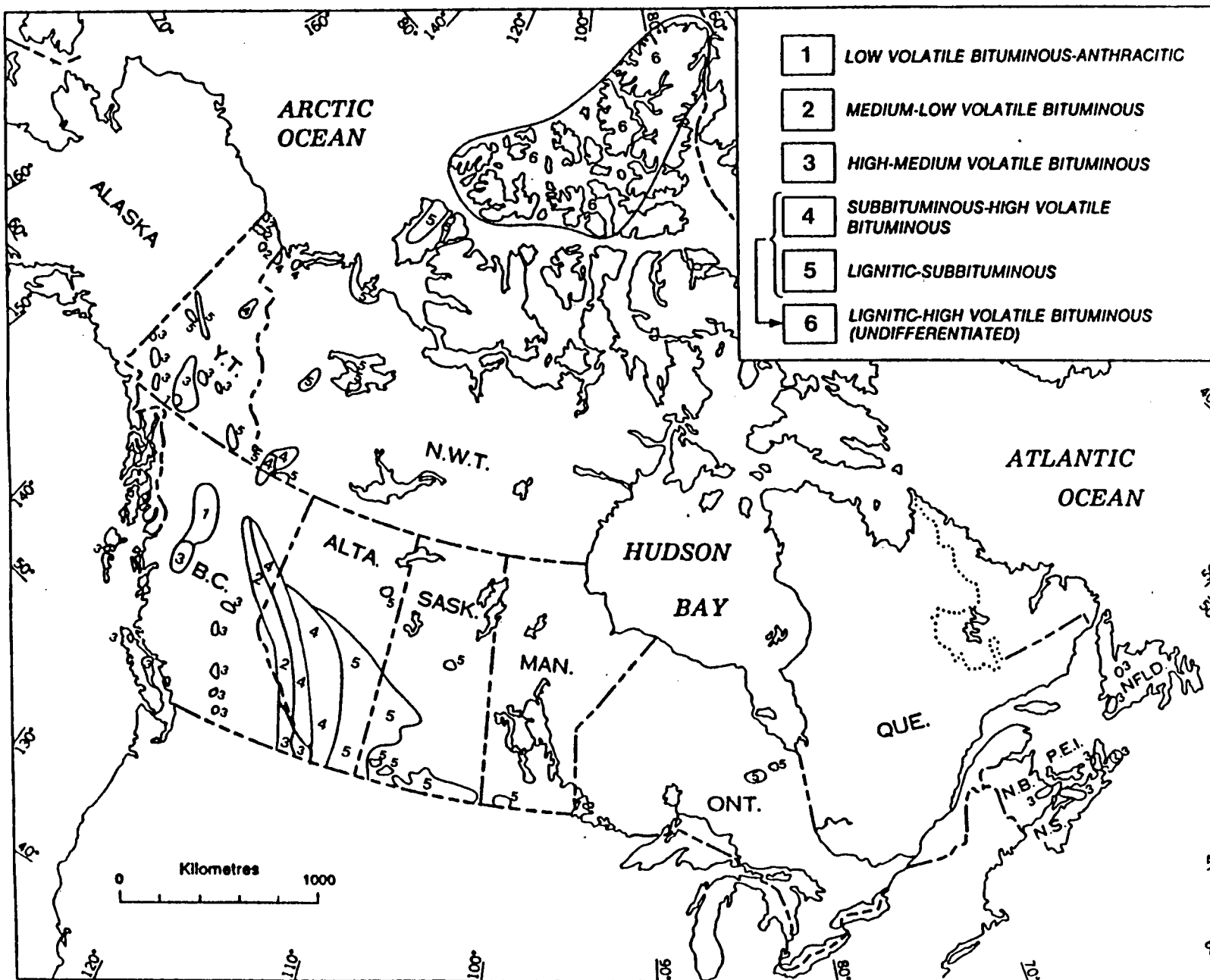

Source: G.S.C. Paper 89-4

Figure 1 Distribution of coal in Canada.

TABLE I ESTIMATED CANADIAN COAL GAS RESOURCES IN MINEABLE COAL, 1988: BY COAL REGION, IN MILLIONS OF CUBIC METRES OF METHANE

COAL REGION	GENERAL COAL RANK CLASS	COAL GAS CONTENT m3/t	EST. COAL GAS RESOURCES CONTAINED IN *COAL RESOURCES OF IMMEDIATE INTEREST*				ESTIMATED COAL GAS RESOURCES CONTAINED WITHIN ***** COAL RESOURCES OF FUTURE INTEREST *****				TOTAL ALL RESOURCES		
			MEASURED	INDICATED	INFERRED	TOTAL	MEASURED	INDICATED	INFERRED	SPECULATIVE		TOTAL	
*** GAS CONTENT FACTOR ***			1.0	1.1	1.2								
<b>COASTAL BRITISH COLUMBIA</b>													
Vancouver Island	hvb-mvb	9	315	792	2160	3267	0	0	3240	0	3240	6507	
Queen Charlotte Islands	lvb-an	13	0	0	156	156	0	0	0	0	0	156	
	hvb-mvb	9	0	149	108	257	0	0	0	0	0	257	
	lig-sub	5	0	0	300	300	0	0	0	3250	3250	3550	
<b>INTERMONTANE BRITISH COLUMBIA</b>													
Northern District	lvb-an	15	1500	8250	18000	27750	0	0	0	78000	78000	105750	
	hvb-mvb	9	270	495	1080	1845	0	0	0	3510	3510	5355	
Southern District	sub-hvb	8	320	1056	3264	4640	0	0	0	0	0	4640	
	lig-sub	5	2250	1760	1620	5630	0	0	0	0	0	5630	
<b>ROCKY MOUNTAINS AND FOOTHILLS</b>													
<b>Front Ranges</b>													
East Kootenays	hvb-mvb	9	12510	13068	43632	69210	0	26730	0	0	26730	95940	
Crowsnest	mvb-lvb	11	2915	1694	6732	11341	0	2420	0	0	2420	13761	
	hvb-mvb	9	2970	1683	6804	11457	0	0	0	0	0	11457	
Cascade	lvb-an	13	3120	1716	7098	11934	0	3003	0	0	3003	14937	
Panther Riv.-Clearwater	lvb-an	13	0	0	0	0	195	215	10920	0	11330	11330	
<b>Inner Foothills</b>													
Southern District	mvb-lvb	11	6985	3872	15114	25971	0	2965	0	0	2965	28936	
	hvb-mvb	9	1350	743	2970	5063	0	0	0	0	0	5063	
Northern District	mvb-lvb	11	12265	27891	82764	122920	0	1210	0	0	1210	124130	
Outer Foothills	sub-hvb	8	6640	6512	18768	31920	0	1760	0	0	1760	33680	
<b>PLAINS</b>													
Mannville Group	lig-sub	2	0	77	240	317	0	0	72	0	72	389	
Belly R./Edmonton/Wapiti	sub-hvb	4	4960	2574	8928	16462	0	3608	0	0	3608	20070	
	lig-sub	2	23720	10857	39780	74357	0	31053	0	0	31053	105410	
Paskapoo	sub-hvb	4	480	264	840	1584	0	110	0	0	110	1694	
Ravenscrag (deep coal)	lig-sub	3	4335	8844	12384	25563	495	12903	84636	0	98034	123597	
	sub-hvb	6	0	0	0	0	7200	26400	360000	663000	1056600	1056600	
<b>HUDSON BAY LOWLAND</b>													
Onakawana	lig-sub	3	510	33	0	543	-	(no available estimates)		-	0	543	
<b>ATLANTIC PROVINCES</b>													
Minto/Lakestream/Beersville	hvb-mvb	9	405	99	216	720	0	0	0	0	0	720	
Sydney	hvb-mvb	11	2750	3872	7458	14080	0	17545	1122	0	18667	32747	
Pictou	hvb-mvb	9	180	248	162	590	0	0	0	0	0	590	
Other	hvb-mvb	9	270	99	1836	2205	0	495	1404	0	1899	4104	
<b>NORTHERN CANADA</b>													
<b>Yukon/District of Mackenzie</b>													
	lvb-an	13	0	0	1404	1404	-	(no available estimates)		-	0	1404	
	hvb-mvb	9	0	0	1620	1620	-	of resources of future interest		-	0	1620	
	sub-hvb	6	0	0	2520	2520	-	in this region)		-	0	2520	
	lig-sub	4	0	0	10992	10992	-			-	0	10992	
Arctic Archipelago	sub-hvb	3	0	0	0	0	0	1650	1980	17550	21180	21180	
	lig-sub	2	0	0	0	0	0	15400	18000	80600	114000	114000	
<b>TOTALS</b>													
	lvb-an		4620	9966	26658	41244	195	3218	10920	78000	92333	133577	
	mvb-lvb		22165	33457	104610	160232	0	6595	0	0	6595	166827	
	hvb-mvb		21020	21248	68046	110314	0	44770	5766	3510	54046	164360	
	sub-hvb		12400	10406	34320	57126	7200	33528	361980	680550	1083258	1140384	
	lig-sub		30815	21571	65316	117702	495	59356	102708	83850	246409	364111	
<b>TOTAL CANADIAN COALBED METHANE</b>			lig-an	91020	96648	298950	486618	7890	147467	481374	845910	1482641	1969259

Gas Content estimate is based on rank & 200m depth for measured resources; 50-100m is used for the Plains, Hudson Bay & the Arctic; 250m for Sydney.  
The Factor for each resource division is based on estimated increasing depth of divisions of less precision and interest. CH4 INTERNATIONAL LTD. 89-02

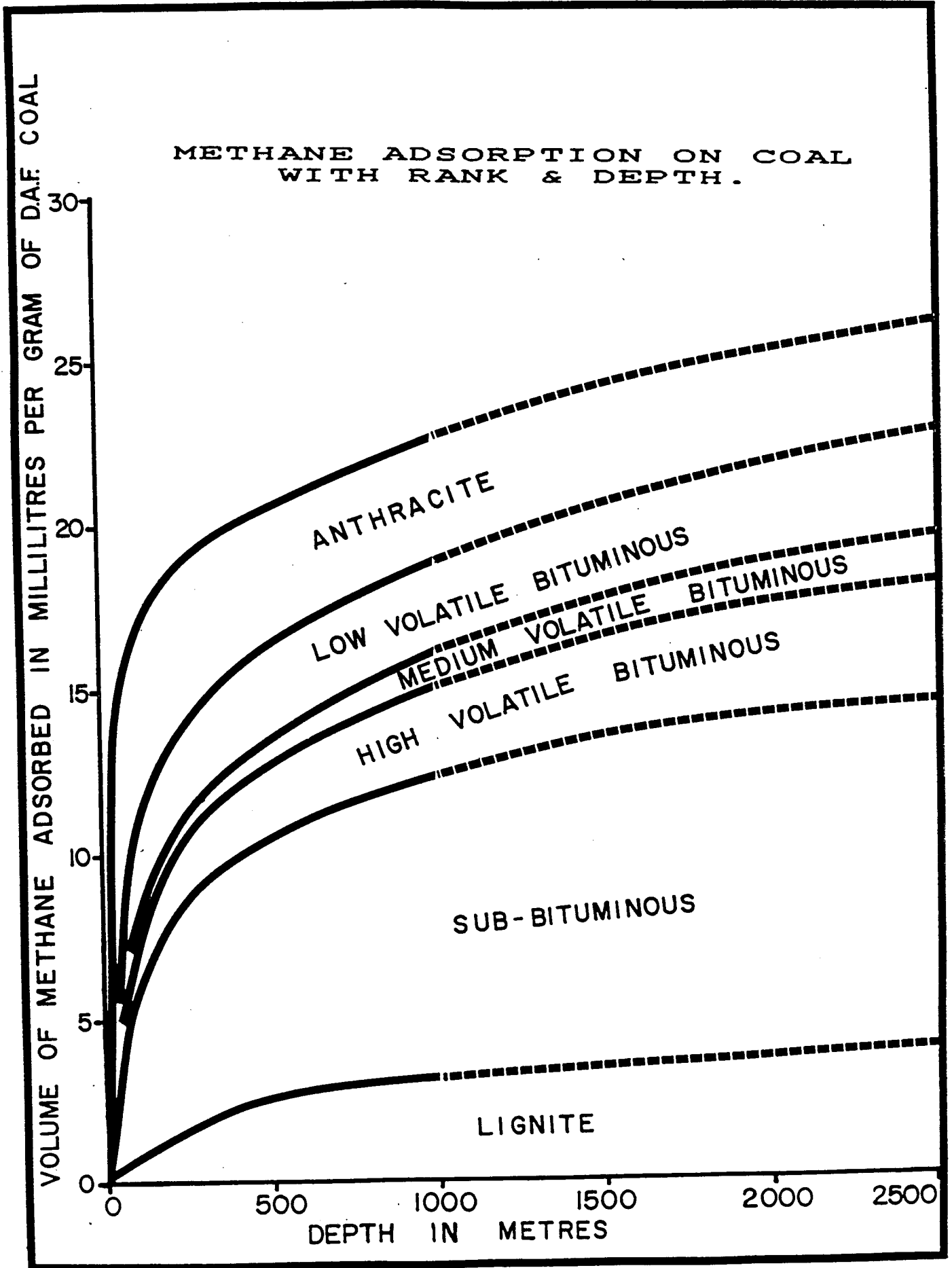



AN OVERVIEW OF ALBERTAN & CANADIAN DEMETHANATION EXPERIENCE,  
TECHNOLOGY ADVANCES AND DEVELOPMENT POTENTIAL

Page 7

=====  
Total coal gas production can be expected to be similar to conventional natural gas wells. Conventional natural gas wells decline fairly steadily in production with time. The annual production rate, however, is usually set by sales constraints, such that the well is depleted in 10 to 20 years, whereas coal gas wells are much less inclined to such a steep decline in production. In fact 70% of initial rates after 20 years is predicted by one model, and a number of wells in the U.S. have increased annually over periods of 10 years or more.

Perhaps the very real scenarios of coal gas replacing any need to build an extremely costly McKenzie Valley pipeline for distant Arctic gas, or the pipeline to Vancouver Island, should be considered very carefully before huge debt loads are assumed. The potential of coal bed methane in Canada had best be part of any forecast! I will also toss this out to producers: How, in light of the Free Trade Agreement and G.A.T.T., do the subsidies being allowed U.S.A. produced coal gas, or possible subsidies on the Canadian side, affect potential export of Canadian coal gas mixed with conventional natural gas to the California market, where we would compete with San Juan Basin or other U.S. coal gas? Not being a tax authority, this is just a thought to be considered.

Wells drilled from the foreslopes to the foothills west should all be evaluated as to the coal gas reserves. The reserves of coal gas from this source alone are very large, with the coal gas potential equal to or greater than the conventional production potential. Presently, regulations preclude a separate operator from drilling for untouched shallower coal gas if a well has tapped deeper conventional natural gas - this in not, in my opinion, conservation. Any producer of a well in western Alberta should most certainly evaluate the coal gas potential: many wells can benefit from a doubling, or better, of reserves. Increased reserves means increased allowable production which means increased cash flow - need I say more!

Recently there has been an awakening to the tremendous potential for the development of coal gas in Alberta, with a number of companies already undertaking projects.

=====

4. EVALUATION OF COAL GAS RESOURCES

In evaluating coal gas resources, some modified or specialized technology is required, but, on the whole, off-the-shelf methods and equipment are utilized. The industry is not high tech, and as such, it has developed rapidly in the U.S.A. due mainly to only a few factors that differ from the case in Canada. In the U.S.A. government has invested heavily to give birth to the industry, royalty incentives are in place, there is not the bubble of relatively cheap gas and there is a larger pool of capital and people willing to work hard and to try something "new". In Alberta there are many areas in which little exploratory work is required because coal resources have been delineated by both coal and conventional petroleum drilling and seismic work. It is expected that, as has happened in the U.S.A., once commercial coal gas production starts in Alberta, there will be a rapid escalation because of the confidence in the market.

5. ALBERTAN AND CANADIAN COAL DEMETHANATION TECHNOLOGY

Technical and academic expertise is readily available locally to assist investors and developers in the recovery of coal gas in Alberta, and in the other parts of Canada. We in Canada often are victims of our own ingrained British attitude of not "blowing our own horn". May I here and now state categorically that we possess excellent technology, which is second to none worldwide. While we here in Canada have a smaller population than in the U.S.A., this does not mean that our technology is inferior. To the contrary, since we're number two we try harder. Since we do a smaller volume of research, we therefore, specialize more. We have also been fortunate in working with other countries besides the U.S.A. In New Zealand, Alberta based virgin coal demethanation technology was applied on the South Island, which was awarded the Alberta Export Achievement Award for 1984. In Hungary we installed the first virgin coal drainage wells in a deep coal mine<sup>9</sup>.

Coal demethanation is among the technologies in which we excel. That said, let me describe some areas of the technology required to exploit coal bed methane, and point out some of our areas of excellence.

=====

5.1 Drilling

Drilling for coal gas can be done by either truck mounted or "conventional" rigs. Methods can be either rotary or air hammer. Here the "coal gas technology" begins to take over. Attention must be paid to the drilling fluid, for use of the incorrect fluid and procedures can inflict serious damage on the coal reservoir. It should also be noted that just because coal is soft, it does not necessarily follow that it is easy to drill through. Friable coal can cause the loss of a well due to squeezing, or at least cause costly delays, should proper measures to control the sloughing not be implemented. We have excellent experience in developing a coalbed methane recovery system utilizing shallow wells (read cost effective) drilled with truck mounted equipment into virgin coal. Well design specifications were optimized for virgin coal demethanation.

Taking this a step further, we have utilized this technology in a number of locations both drilling from surface and from underground. Figure 4 shows a number of coal mine drainage systems, including wells drilled into seams below the active mine.<sup>10</sup> An example of this is in Hungary, where I worked on a project, which for the first time, successfully completed a number of holes and wells by drilling from active workings almost 1000 metres underground, into seams below. These seams are extremely friable and quickly close in around the drill pipe, often preventing drilling through them. The coals are very gaseous and outburst prone, and many deaths still occur from time to time. Gas contents of 50 to 100 cc/g (600 to 3200 cubic feet per ton) have been reported. In areas even 3 m diameter, steel arched tunnels squeeze almost closed in a few months.

5.2 Sampling

Recently, a number of people have contacted me at CH4 International with questions on sampling, so I include some information detailing this. In measuring the gas content of the coal seam, either a core or cuttings can be used. The core is preferable, but more costly. Wireline, split tube is best, and if budgets allow, a pressure core for deep coals. Also, when obtaining samples, methods used apply specifically to coal gas technology.

A sample needs to be sealed in a canister as rapidly as possible to lessen the amount of gas lost, since the coal starts to desorb as soon as the pressure is removed. Therefore a good canister design closes quickly and seals easily. CH4 International has designed plastic canisters with convenient features incorporated, such as modified threads, integral O-ring and the use of a quick connector to connect a pressure gauge or a hose for reading the gas.

**CH4 International Ltd.**  
 806 - 48 Street, N.E., Calgary, Alberta, CANADA T2A 4L9

**COAL MINE DRAINAGE SYSTEMS**

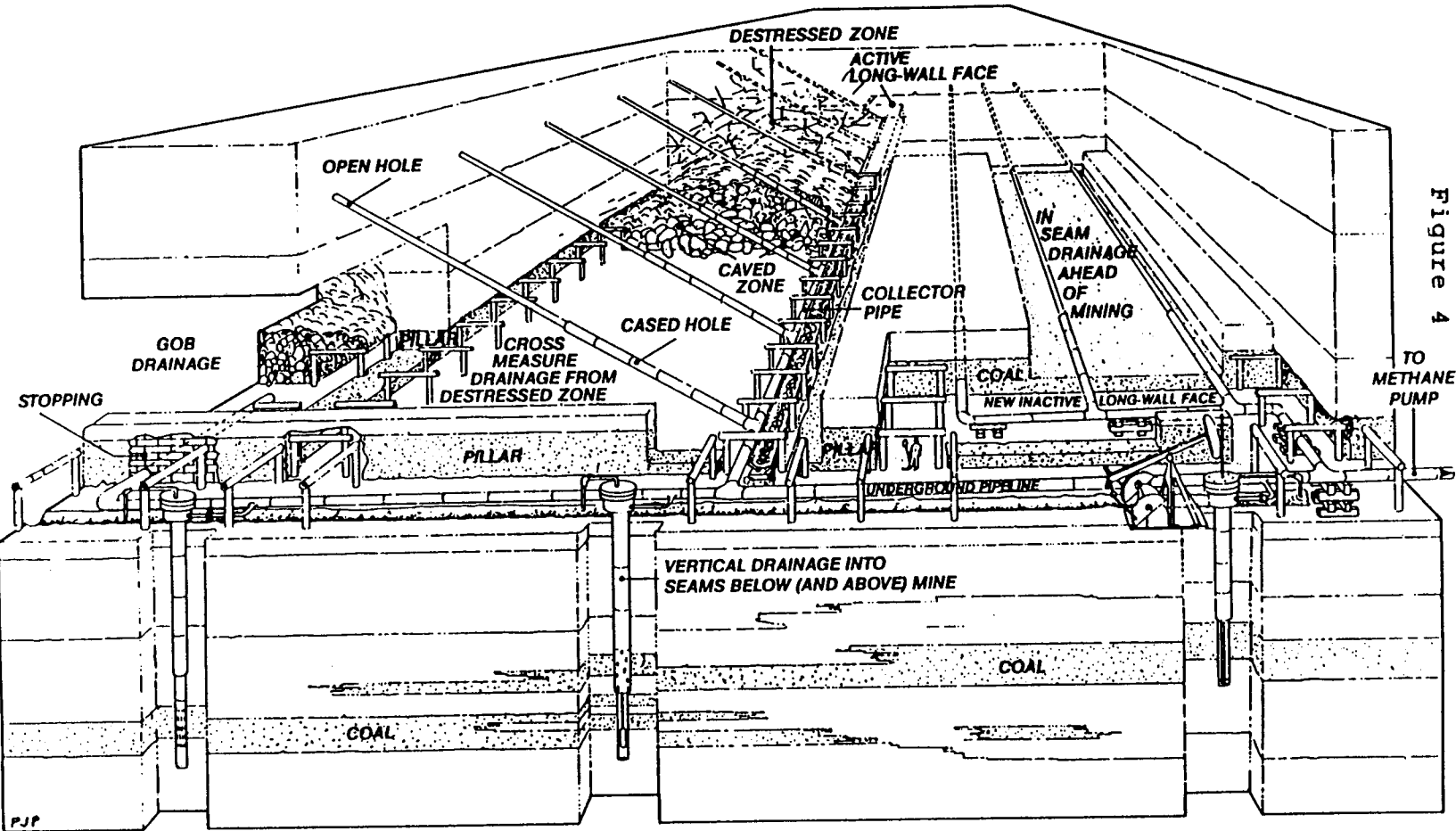

Figure 4

AN OVERVIEW OF ALBERTAN & CANADIAN DEMETHANATION EXPERIENCE,  
TECHNOLOGY ADVANCES AND DEVELOPMENT POTENTIAL

Page 11

=====  
The apparatus used to measure the desorbed gas, consisting primarily of the canister, a hose and an inverted, water filled graduated cylinder, plus ancillary items, is shown in Figure 5.11. A standardized method, referred to as the U.S.B.M. Method<sup>12</sup> is used to obtain comparable estimates of the gas content. At approximately predetermined intervals<sup>13</sup> the valve on the canister is opened and the desorbed methane is bled through a hose into the bottom of the inverted, water filled graduated cylinder.

CH4 International Ltd. has developed a comprehensive computer spread sheet programme to perform all the S.T.P. calculations, which also, for the first time, includes making corrections for the differential pressure in the graduated cylinder. Corrections are especially necessary in Alberta because of the altitudes encountered, where errors 30% to 50% can occur if proper corrections are not made (in Alabama's Black Warrior Basin, errors are not as serious because of the low altitude). All pertinent data is included, and calculations are also made for time zero, rank, dry, ash-free analyses from the proximates, theoretical gas contents for either the chip or core sample, and the grab sample, and the measured gas content, which includes the extrapolated lost and residual gas. Some of our clients have requested these values be expressed in terms of seam volume as well, no mean task considering the variables. The data, square root of time from a calculated time zero against cumulative desorbed gas, are plotted on a graph.

The sample and desorption data sheet<sup>14</sup> (Figure 4) and the desorbed gas graph<sup>15</sup> (Figure 5) which follow are examples of drill cuttings, or chip, samples. CH4 International has modified the sampling procedures and the U.S.B.M. method, and we are obtaining quite acceptable results using chips, which can be further refined by calibration against other methods. This graph shows the very large amount of lost gas chips give off because of their small size, and length of time before canistering, about 2 hours lag and delay here. This lost gas has been verified with other data and calculations; note also that time zero is not the time of drilling, but is a precise calculation, which affects the lost gas estimate. The data sheet shows input and output, but does not indicate the large amount of background calculations and tables which are a part of the report.

The proper use of drill cuttings samples can give economical results, and quite accurate and comparative gas contents of a well.

808 - 48 Street, N.E.  
 Calgary, Alberta, CANADA  
 T2A 4L9  
 Telephone 1 (403) 273-6296

# CH4 International Ltd.

## COAL GAS MEASUREMENT APPARATUS

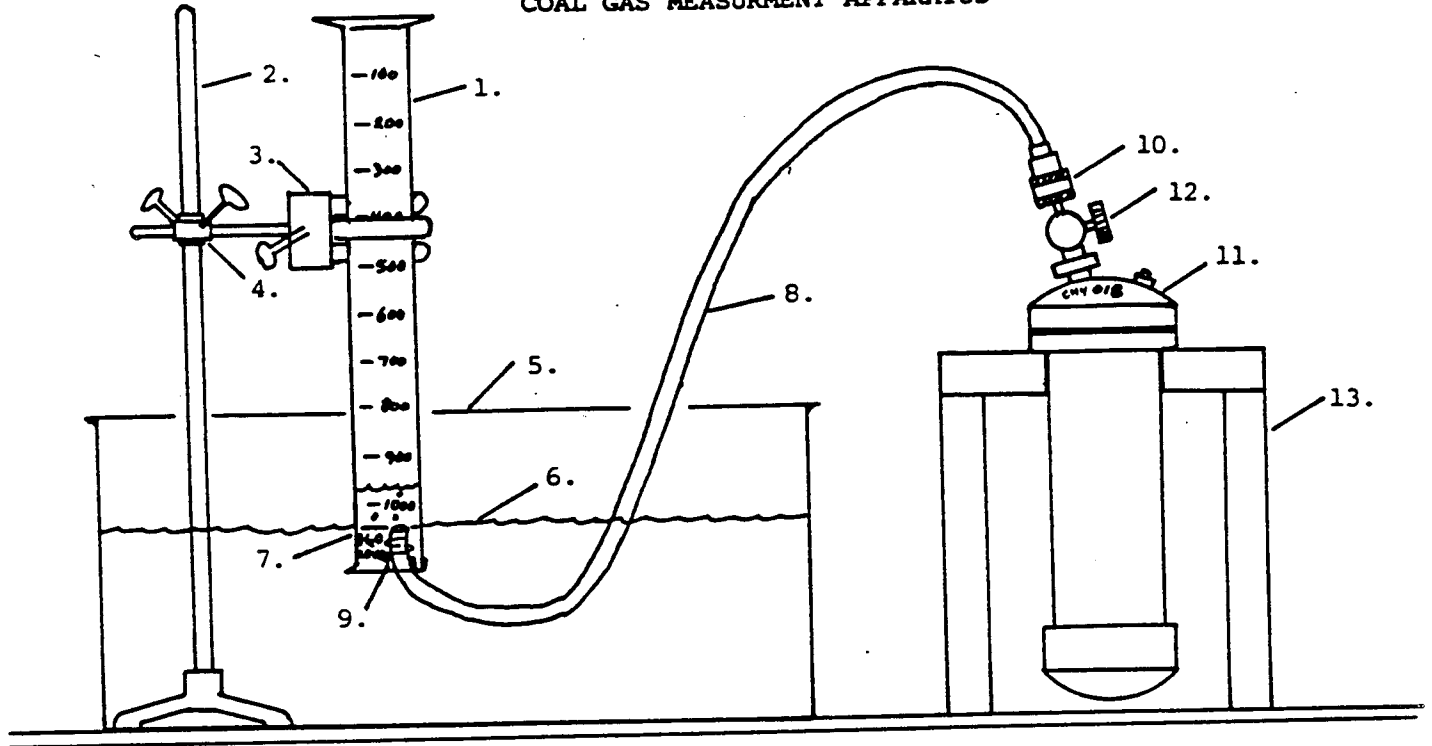

14.

DATE 15-6-10 TEMP 30 °C			
PRESS. 1013.25 hPa			
CAN. NO.	TIME	START	STOP
014	13:21	000	420
015	13:22	420	120
016	13:23	120	700
017	13:25	000	750
018	13:27	000	
019			
020			
021			

CH4 International Ltd.

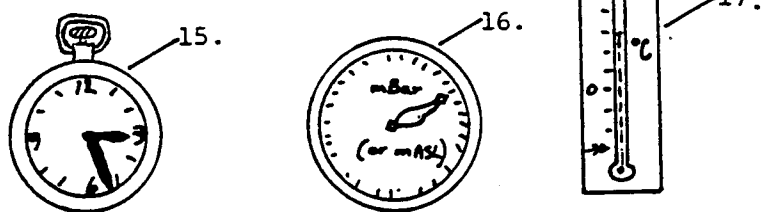

### EQUIPMENT LIST

1. 1000 ml Graduated Cylinder
2. Ring Stand
3. Clamp
4. Clamp Holder Bracket
5. Water Tub
6. Water Level
7. Water Level Mark on Cylinder
8. Hose, 1/2"
9. Wire Clip, Holding Hose at Water Level
10. Quick Connector, Ensure Positive Connection
11. Sample Canister
12. Valve, Ensure Well Tightened
13. Canister Stand
14. Clip Pad and Pencil
15. Time-piece
16. Atmospheric Pressure (Absolute)
17. Thermometer
18. Pressure Gauge with Quick Connector, (OPTIONAL), ±30 PSI / ±200 kPa

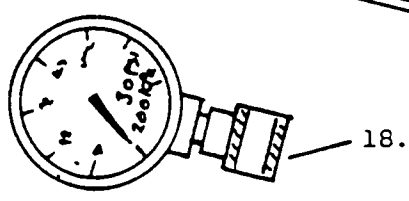

**CH4 INTERNATIONAL LTD.**

**DESORPTION PROJECT -- Coal Sample Canister Gas Readings**

CANISTER NO.: CH4IL 000 WELL NO.: 1 Date Sampled:(yrd).. 01-17 day of yr: 17 Seam: '1'

Well Name: Formation: Calc. Fm. Temp. °C: 65.5

Sample Depth (Driller): 2220.2 m to ..... 2221.2 m Length: 1.0 m Core Run No.: ---N/A--- Recovery: ---N/A---

Time of Cutting:.... 15:45 hr to.... 15:49 hr Lag: 91 min.Delay: 25 min.

Start of Sampling:.. 17:40 hr Time Finished: 17:43 hr Sample Washed? Yes +40 Mesh

T(c):..... 17:45 hr T(o): 16:23 hr T(c): 1065 min.;T(o): 983 min. from 00:00 hr.

Lost Gas Time:..... 82.0 min Sq.Rt.(LGT): 9.1 min<sup>^</sup>.5 Mud: Gel-Chem

Notes: Opened canister at reading #8; light foamy coal on water; not poured off. 100cc gas samples:  
 ----- g1, g2, g3, g4, g5, g6, g7, g8, g9 taken after reading nos. 2/3, 4, 5, 6, 7, 8, 9, 10, 12

Mean Surface Temperature: 10.0 °C. GeoGrad: °C/m: 0.025 Hot Wire: 368/120 units Blender Dry: 190 u.; 17th @ 18:15 hr

CANISTER WTS: Gross: 4385 g Tare: 2291 g Net: 2094 g Blender Cuttings Wet: 184 u.; 17th @ 18:05 hr

Grab Sample No.: 003 Date Grab Bagged: 01-17 Chip Sample No.: CH4- Date Chips Bagged: 04-14

	GRAB SAMPLE (IF TAKEN)					CHIP SAMPLE (AFTER DESORPTION)				
	Wt. g	H2O %	Vol. %	Ash %	F.C. %	Wt. g	H2O %	Vol. %	Ash %	F.C. %
As Received:	759.2	31.87	10.01	45.46	12.66	2094.0	29.28	13.47	37.76	19.49
Air Dried:	523.8	0.86	14.56	66.15	18.43	1502.4	1.03	18.85	52.85	27.27
Dry Basis:	517.2	0.00	14.69	66.72	18.59	1480.9	0.00	19.05	53.40	27.55
Dry Ash-Free:	172.1	0.00	44.13	0.00	55.87	690.2	0.00	40.87	0.00	59.13

Rank: High Volatile A Bituminous Dry Clean Coal Dens: 1.282 g/cc RO: Heat DAF: 14356 Btu/lb

GAS: Measured: 2143 cc Lost: 3000 cc Resid.: 300 cc Total: 5443 cc Calc.Seam Dens.: 2.059 g/cc

GRADUATED CYLINDER INFO: Height: 35.00 cm Size: 1000 cc Tank Rise/cc: 0.0005 cm Index: 2.50 cm to Mark.

CALC. GAS CONTENT: cc/g DAF Coal GRAB: 20.28 CHIP SAMP: 19.91 MEASURED GAS CONTENT: 7.89 cc/g Clean Coal!

CALC. GAS CONTENT: m<sup>^</sup>3gas/m<sup>^</sup>3seam GRAB: 17.98 CHIP SAMP: 17.65 MEASURED GAS CONTENT: 6.99 m<sup>^</sup>3gas/m<sup>^</sup>3seam

**READINGS**

No.	Date	Day	Time	Sq. Rt.	El. m;	Grad. Cyl. Readings	Adj. Grad. Cyl. Readings	STP	Total	Grad. Cyl.		Adj. Grad. Cyl.		STP	
										Start	Stop	Start	Stop	Dsb.	Dsb.
1	1 17	17	17 50	87	9.3	0.0	907	22	0	0	0	0	0	0	0
2	1 17	17	18 0	97	9.8	0.4	907	22	0	100	100	0	80	80	80
3	1 17	17	18 30	127	11.3	1.0	907	22	180	310	130	144	249	105	185
4	1 17	17	19 30	187	13.7	1.1	906	22	0	180	180	0	144	144	329
5	1 17	17	23 15	412	20.3	3.0	905	22	0	400	400	0	322	322	651
6	1 18	18	4 57	754	27.5	3.1	903	22	0	380	380	0	305	305	956
7	1 19	19	5 30	2227	47.2	3.8	920	22	0	460	460	0	378	378	1334
8	1 21	21	19 0	5917	76.9	3.0	907	20	0	425	425	0	346	346	1680
9	1 23	23	6 3	8020	89.6	0.9	918	22	0	160	160	0	130	130	1809
10	1 31	31	13 30	19987	141.4	1.6	897	20	0	250	250	0	200	200	2009
11	2 14	45	10 8	39945	199.9	0.3	891	18	30	120	90	24	95	72	2080
12	3 14	73	16 8	80625	283.9	0.2	884	19	0	80	80	0	63	63	2143
13	4 14	103	9 44	123441	351.3	0.0	892	19	0	0	0	0	0	0	2143

**SAMPLE ONLY**

Additional Notes:  
 5 cm foamy, black water on top when opened to bag, partially, centrifuged. Sample bubbled when tapped.

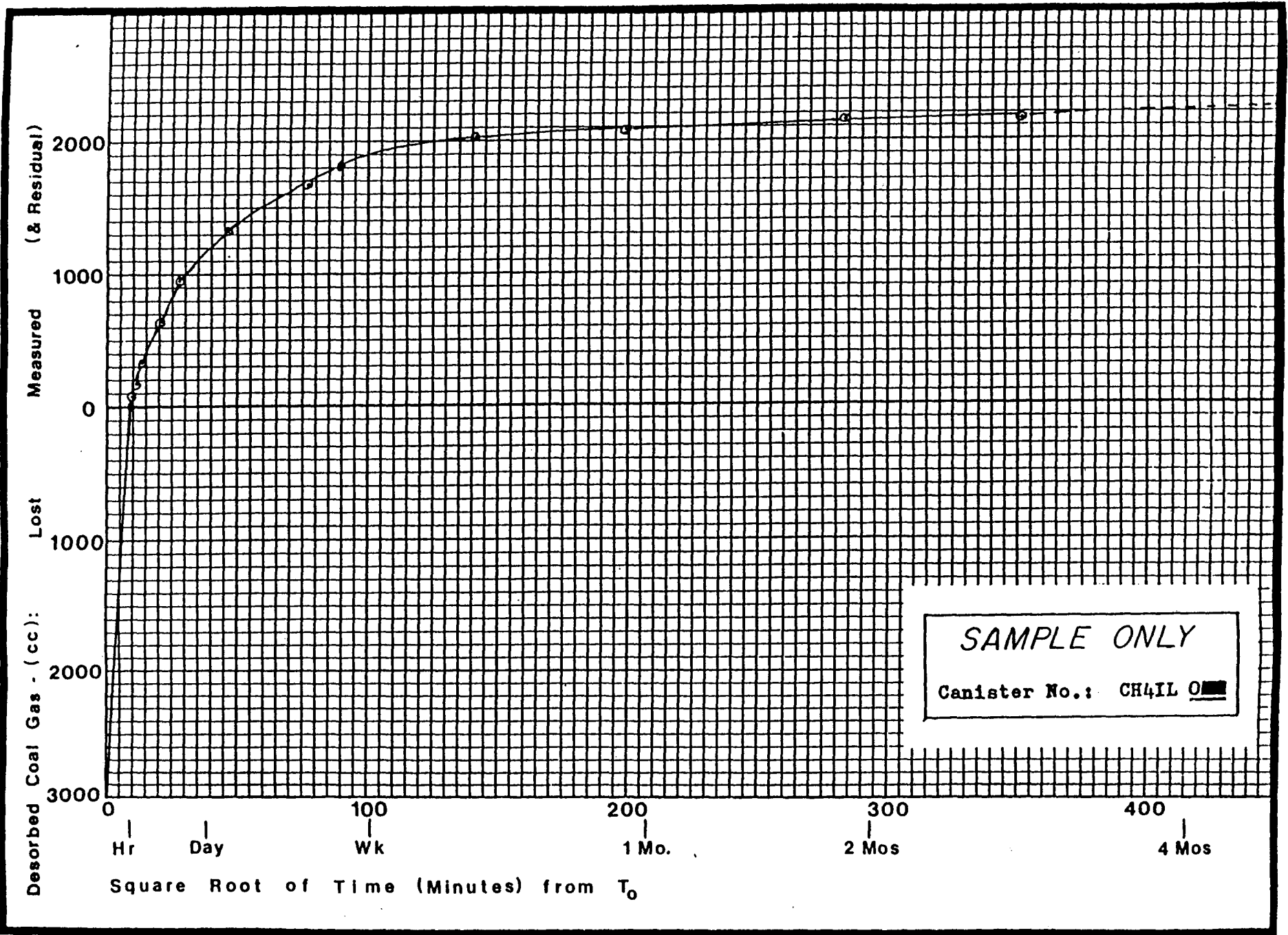



=====

As part of the calculations, the rank of the coal is determined. This is used in making comparisons of one site against another, and in calculating the in situ bulk density. For those not familiar with ranking or maturity of coal, the rank of the coal is best determined using the reflective index. If that is not available, then if the dry, ash-free fixed carbon ratio is 0.69 or better, the the higher ranks are determined. For ranks under medium volatile bituminous, the heating value is used. In determining the coal in situ bulk density, an estimate of porosity and clean coal density is given for each rank. The increase in clean coal density with coal rank is not linear. The density of lignite is very low, and rises with increasing rank to a small peak at high volatile bituminous C / subbituminous A, then falls somewhat, and rises again to a high at meta-anthracite. The porosity is very important, and if ignored can cause very considerable errors in bulk density and coal quantity, and hence, in gas in place calculations. (Proper logging methods, discussed later, are essential.) For example S.W. B.C. is 6%, Grand Cache is 15% and Quintette is 12% to 38%.

We have developed improved sampling methods in Alberta that assist in making a better assessment of the gas reserves. Crews experienced in coring coal can make a project and get good recovery of the core, where others may loose much or all. Losses will occur in the softer, vitranite rich zones, which contain the most gas. Core bits range from fine diamond bits to coarse carbide drag type bits for soft formations. Large as carbide teeth can be, excellent recoveries are obtained. (I have experienced 99% on one difficult project.)

A good drilling and coring crew is worth the cost; this has been proven on many occasions.

### 5.3 Early Evaluation While Drilling

Additionally, a method to aid in evaluating the productivity while drilling has been developed. This method, which uses a hot wire gas detector, allows a much better decision to be made to case or abandon a well prior to awaiting the results of desorption of samples. In that 2/3 of the cost of well might be spent on the casing, an early decision is well worth the cost of executing this programme. Three uncased wells could be drilled for the cost of one unnecessarily cased well. Similarly, if casing a well is postponed until the results of the desorption are complete, extra rig charges are involved, and it may not be possible to install the casing without reaming the hole due to squeezing.

AN OVERVIEW OF ALBERTAN & CANADIAN DEMETHANATION EXPERIENCE,  
TECHNOLOGY ADVANCES AND DEVELOPMENT POTENTIAL

Page 16

=====

The hot wire detector responds to gas released from the drill fluid, be it air, water or mud. Both gas released as a result of the drill bit pulverizing coal, and gas released from the well bore as a result of desorption and free gas flow are measured. The unit also responds to gas being released from adjacent rocks. By calibration of the response against other data, seam to seam and hole to hole comparisons can be made, which give a good indication of both the gas content and the production rates (influenced by permeability). As data are gathered in a field, the evaluation becomes more quantitative.

Geophysical Well Logging

All wells need to be logged, however, regular oil patch logging is NOT sufficient to recover all the information needed. We in Alberta are very fortunate in that high resolution, coal calibrated, state of the art, coal logs are available here in Calgary.<sup>16</sup>

An example of this need to use good logs is illustrated by the example of one well we were restimulating for multiple seam completion (refer to Figure 8)<sup>17</sup>. The original logs showed one seam to be better than the rest for both thickness and quality, with an apparent bulk seam density of 1.34 to 1.37 g/cc. When this was relogged with a properly calibrated coal log, along with a collar locator to locate the perforation location, it was found that the density was 1.85 to 1.93 g/cc, certainly not a good quality coal. This same log was able to show that a lower, barefoot seam that had initially been stimulated, was well fractured, and its apparent seam density had gone from a compact 1.39 g/cc (correctly about 1.60 g/cc) to a pulverized 1.15 g/cc. Also, the "shale" is shown as a uniform density 2.40 g/cc on the former log, but is shown more correctly as 2.31 to 2.75 g/cc on the newer log. There is better resolution (thinner defined peaks), better separation of densities (no sharp "break" from the base line) and a higher count rate which gives less statistical error. Logging of this quality is not available in other parts of Canada or the U.S.A. Coal logs should consist of gamma/neutron, caliper, density and focused resistivity. From these, IF they are good coal logs, then a programme to determine the amount of in situ coal, water and ash can be executed; these values are derived totally independant of core data. This information gives the in situ porosity estimate, which often cannot be determined with any accuracy from a coal core, due to its friable nature. If the well is to be cased for production, then also logging after the casing is set can show cement invasion. Current experimental tests are being conducted on the ability to determine clay content directly.

"AFTER"

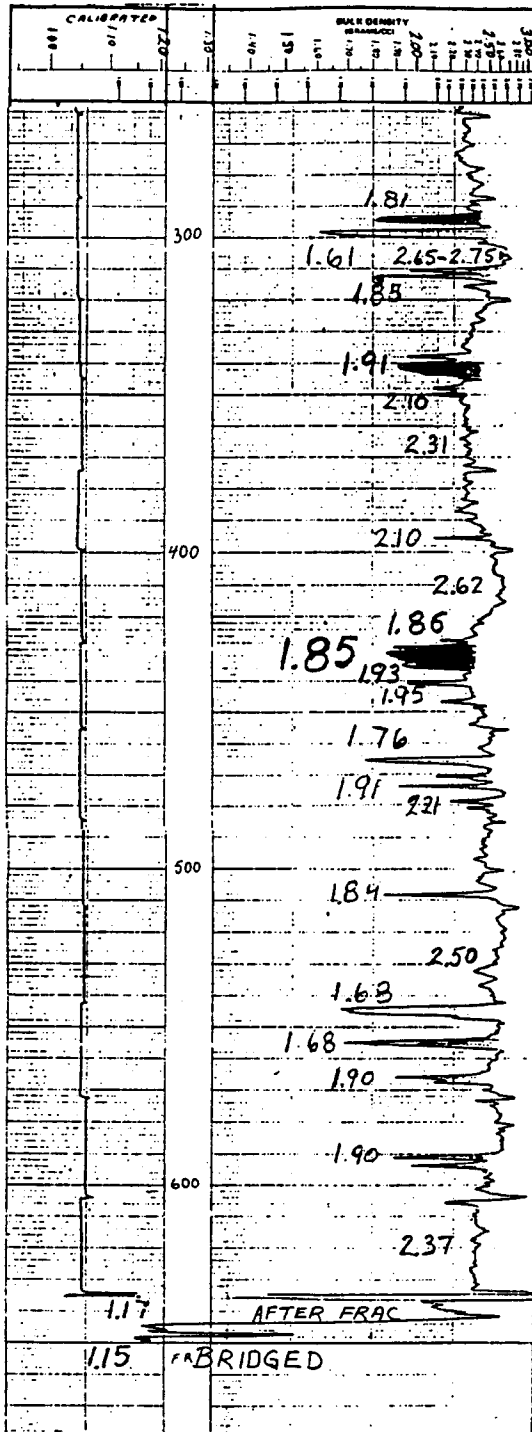

"BEFORE"

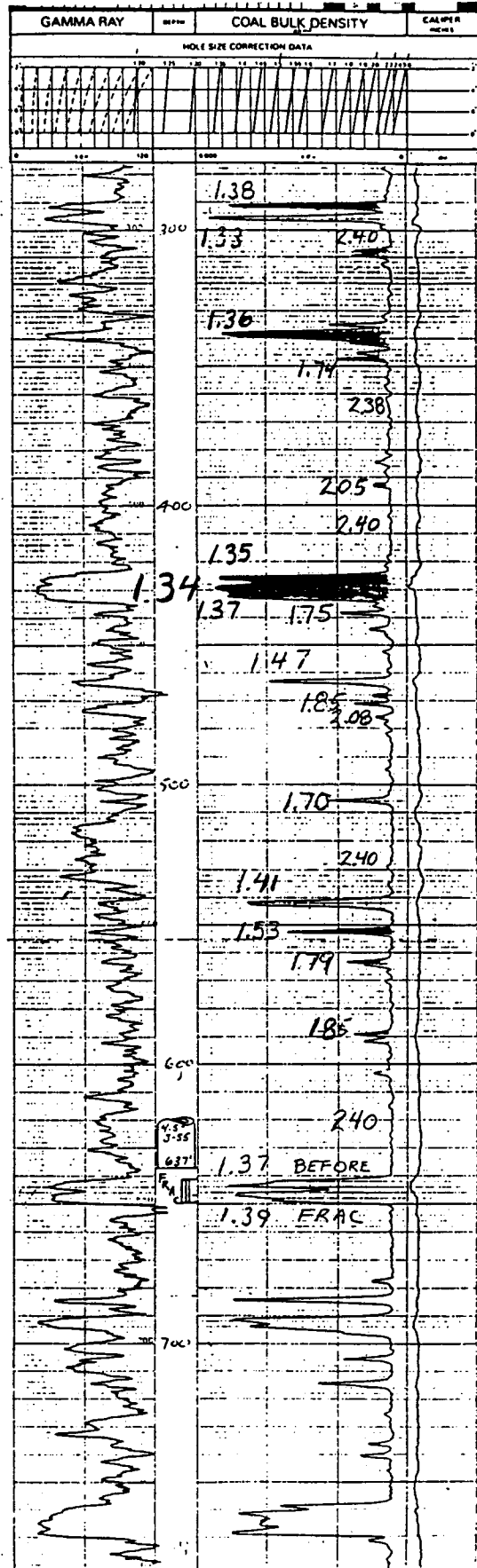

=====

5.5 Stimulation Methods

Hydraulic Fracturing

Most coal bed methane wells are stimulated. Most commonly a hydraulic fracture is the method of choice. There are many variations, some superior to others. Many different types have been tried experimentally in Alberta and Canada. Basically water, commonly foamed with nitrogen, is pumped at high pressure into the coal seam, usually with sand as a proppant.

The surface equipment consists of a pumper, water trucks or tanks, nitrogen units and a proppant handling system. In some instances a coal seam is self propping and the frac does not need a proppant which can find its way into the pump. The fluid is forced into the seam which, when the pressure is sufficient, breaks. The fluid then opens up a vertical channel in the seam, parallel to the face cleat, or major fracture direction. Some branching along the butt cleat, other face cleat planes and seam partings also occurs. It is somewhat a paradox that the frac works, because in opening a channel, the adjacent natural fractures are closed up, which slows the methane flow, and also the desorption. Its main advantage may be in pulverizing coal, which quickens desorption.

The mining community in the U.S.A., New Zealand and elsewhere, has argued that an hydraulic fracture damages the roof (and floor), which causes increased mining hazards and costs. For this reason some jurisdictions have not allowed a frac to be done. Very strong evidence exists, however, that a frac does not produce these results. Quite a number of fracs have been mined through and investigated. The fracs have been found to be vertical, terminating at the floor and often coming short of the roof. One U.S.A. mining company that has argued against the frac when someone else owned the gas rights, goes right ahead and fracs its own predrainage wells, which does little to give credence to their argument.

Fracs can be done from surface or underground, in deep or shallow wells, and in fact, in Alberta, the shallowest successful frac ever done, was on a coal gas well at a depth of 45 to 60 metres. The frac works fairly well, increasing production rates about ten fold. Frac technology has been around for quite some time, and is readily available from a number of service companies.

=====  
Cavity Stress Relief Method

Another way of stimulating coal seams is called the Cavity Stress Relief Method. This works somewhat opposite to the frac, and it was perfected right here in Alberta in 1980 and is patented world wide.<sup>18</sup> As part of Alberta mountains research we continued work started by Dr Denes Masszi<sup>19</sup> a number of years ago in Hungary where the concept was designed based on his understanding of the collapse of mine workings to relieve stress. This technology was refined by modifying a dual wall drilling system and designing some specialized tools.

The surface equipment consists of a high pressure water pump, a high capacity source of air, some sort of water handling system, a cased well with a rotating blow out preventer and a rig with dual wall pipe and swivel. The high pressure water is injected through the dual wall swivel into the annulus between the two pipes. Air is pumped into the well casing. A slurry of excavated coal, water and air is ejected out the center pipe.

The downhole system operates as follows: the high pressure water is pumped down the annulus between the inner and the outer pipes and out nozzles where a cavity is cut in the coal seam. A large volume of air is pumped down the annulus between the outer pipe and the casing. The air pressure is used to maintain the water level in the well below the jet level, thereby preventing the rapid attenuation of a submerged jet. A modified tricone bit is used as a downhole crusher for oversized particles. This proved to be a simple solution to solve the problem of the hole clogging.

The dual wall drill pipe and equipment is built here in Calgary,<sup>20</sup> but the downhole tools are custom made. The jet can cut 5 metres or more. In Alberta, this method has removed 80 and 50 tonnes from 8 and 5 metre seams at a depths of 310 and 70 metres during the development of the process.

The stimulation is not instantaneous as in a frac, as the seam must collapse into the cavity. The wellbore is maintained by use of a slotted liner. The large relaxed and fragmented zone around the cavity desorbs very effectively, since the zone is radial around the well, and not linear as is a frac.

=====

5.6 Completions and Pumping Systems

Figure 9 illustrates some different demethanation well designs.<sup>21</sup> Single seam completions are shown, for both open and cased holes. Two of the most popular pumping methods are shown, the horse head pump jack with sucker rod and tubing pump, and an electric submersible. Either type works well, but the submersible is preferred, especially for shallow wells, because of its ease of servicing, and ability to move large amounts of water. Following stimulation, a well must be properly cleaned up to prevent coal fines and frac sand from entering the pump. We experimented with a number of methods to come up with what we felt were optimum techniques. In one of our wells we were able to keep an electric submersible pump in operation for three years. It was still in excellent condition when pulled. The best U.S. record on submersible pumps to that date was three months, and in fact submersible pumps were not even being recommended. After trying a number of different pumps and systems we were able to specify a very successful type of pump, that was more economical, and lasted longer, than others. Underground, in Hungary, with electricity unavailable, I was able to specially design a plunger pump system, using mine air for power; this was a first, and was made possible because local suppliers and Hungarian technicians were willing to modify stock items.

5.7 Well Operations

In our harsh Albertan and Canadian conditions, demethanation well operations are not considered ideal. Wells have to be kept in operation throughout the cold of a prairie or mountain winter. Gas pipes, full of wet gas tend to freeze off, and water disposal can become a problem. The wellhead and pipes have to be insulated and heat traced. This is easiest for submersible pumps; sucker rods need to be radiant heated.

Wells need to be operated properly to sustain production. An operator visits the site regularly to monitor production and to check if servicing is needed. Demethanation wells cannot be easily turned on and off, as can conventional natural gas wells, because of the problem of having to dewater. Also some wells just do not return to full production. Good, prompt identification and servicing of problems helps to keep a well on stream.

Wellsites can be installed such that the sites are small, with little surface disturbance, which helps make coal gas preferable to conventional natural gas. The wells could be located within residential areas.

# CH4 International Ltd.

808 - 48 Street, N.E.  
 Calgary, Alberta, CANADA  
 T2A 4L9  
 Telephone 1 (403) 273-6296

## DEMETHANATION WELL DESIGN

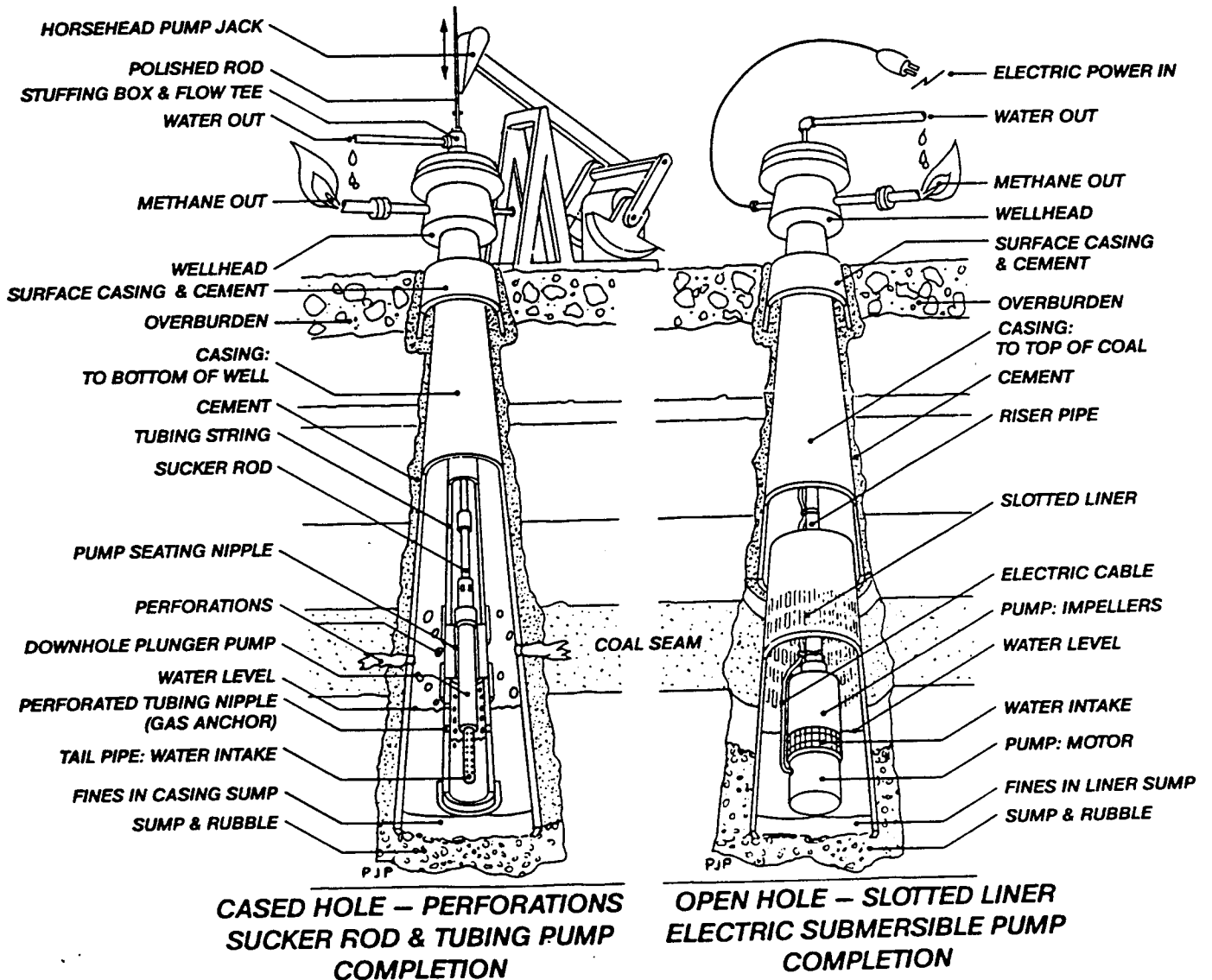

AN OVERVIEW OF ALBERTAN & CANADIAN DEMETHANATION EXPERIENCE,  
TECHNOLOGY ADVANCES AND DEVELOPMENT POTENTIAL

Page 22

=====

5.8 Communications and Environmental Awareness

Good communications, and anticipating problems go a long way to successful operations. As an example of this, I mention an old coal miner I had the pleasure of meeting on Vancouver Island. By cooperating with this land owner, and moving our test hole location somewhat, I was able to save the cost of abandonment by turning over an excellent water well for him. He put together about three long extension cords and has a small pump installed to water his garden, which chore he did previously by packing water by hand. When it comes to reclamation, two words of advice: "don't scrimp". I have worked within government, and believe me, a good track record for environmental and reclamation work will put you in good stead with the ministry and simplify permitting, etc.

6. SUMMARY

I hope I have given you some insight into the potential for successful demethanation in Alberta, or elsewhere. While Alberta and Canada are now playing catch up to the U.S.A. in getting coal bed methane production underway, we have the advantage of a vast potential. There is a lot of gas contained in just a little bit of coal.

I have been in the coal gas business since 1980, working mainly hands-on in the field, installing properly completed wells and producing coal gas. As such I was fortunate to have an opportunity to gain this unequalled direct experience in practical demethanation, both in Canada and abroad, as well as in design and theory. I started CH4 International Ltd. in 1987, which has been continuously providing quality coal demethanation services and solutions to clients since its inception. We have put together a qualified team of experienced and qualified people to economically design, evaluate, install and/or operate coal gas and methane management projects. Alberta has the resources and the expertise; all that is now required is commitment and determination to start production of coal gas.

-----

This is the full text version of a slide presentation of this paper given at the Coal Bed Methane in Alberta - What's It All About seminar, sponsored by the Alberta Research Council and the Alberta Geological Survey, at the Calgary Convention Centre, January 30 - 31, 1990.



AN OVERVIEW OF ALBERTAN & CANADIAN DEMETHANATION EXPERIENCE,  
TECHNOLOGY ADVANCES AND DEVELOPMENT POTENTIAL

Page 23

=====

7. FOOTNOTES

1 The project was initiated by Alberta Gas Trunk Line, prior to its name change to Nova, an Alberta Corporation. The author of this paper worked on this project from 1980 to its shutdown as a field supervisor.

2 Murray, Keith; speaker at this seminar.

3 Masszi, D. and Proudlock, P., CH4 International Ltd., Calgary, Alberta. Reduction of Fugitive Methane Emissions Originated from Various Canadian Sources. Company files, p 14 (of the original), March, 1989.

This report was prepared for, and incorporated in, the Ontario Ministry of Energy's "Study on the Reduction of Energy-Related Greenhouse Gas Emissions (prepared by DPA Group Inc.). This in turn was included in the Federal/Provincial/Territorial Energy Ministers' Task Force on Energy and the Environment report on "Reducing Greenhouse Gas Emissions", Aug. 1989.

4 Op cit. supra n.4 pp 6-7.

5 Source: Smith, G.G. Paper 89-4: Coal Resources of Canada. Geological Survey of Canada. Ottawa, 1989.

6 Op cit. supra n.4. Coal gas resources calculated after n. 5.

7 CH4 International Ltd., after Kim, A.G. "Estimating Methane Content of Bituminous Coalbeds From Adsorption Data", U.S. Dept. of the Interior, Bureau of Mines Report of Investigations 8245. Washington, D.C., 1977.

8 The Elmworth field produces from Falher coals and adjacent conglomerates and sands. Refer to: Wyman, R.E., Canadian Hunter Exploration Ltd., Calgary, Alberta. "Gas Resources in Elmworth Coal Seams" in A.A.P.G. Memoir 38, pp 173-187, 1984.

9 Zoback Shaft of Mecsek Coal Mines, Komlo, Hungary. The author spent 7 months working on this project in 1986 and 1987.

10 Proudlock, Peter J. "Coal Mine Drainage Systems" series of drawings. CH4 International Ltd. files. Calgary, 1985.

11 Proudlock, Peter J. Drawing from a brief titled: "Coal Sampling Method for Desorption of Methane", CH4 International Ltd. files. Calgary, 1985.

12 Kissell, F.N., McCulloch, C.M., and Elder, C.H. "The Direct Method of determining Methane Content of Coalbeds for Ventilation Design", U.S. Bureau of Mines Report of Investigations 7767. Washington, D.C., 1973.

=====

AN OVERVIEW OF ALBERTAN & CANADIAN DEMETHANATION EXPERIENCE,  
TECHNOLOGY ADVANCES AND DEVELOPMENT POTENTIAL

=====  
This method did not determine residual gas and was later modified by: McCulloch, C.M., Levine, J.R., Kissell, F.N. and Deul, M. "Measuring the Methane Content of Bituminous Coalbeds", U.S. Bureau of Mines Report of Investigations 8043. Washington, D.C., 1975.

13 These intervals, somewhat modified, are approximately as follows:

<u>READING NO.</u>	<u>INTERVAL TIME</u>	<u>TIME FROM Tc</u>
1	5 min	5 min
2	10 min	15 min
3	30 min	45 min
4	1 hr	1 hr, 45 min
5	2 hr	3 hr, 45 min
6	6 hr	6 hr, 45 min
7	12 hr	18 hr, 45 min
8	1 day	2 days (approx.)
9	2 days	4 days
10	4 days	8 days
11	1 week	2 weeks (approx.)
12	2 weeks	4 weeks
13	1 month	2 months (approx.)
14	2 months	4 months

Tc is the time of closing the canister. Readings after number 5 are more or less arbitrary, and numbers 7 and 8 are often combined. Core readings may extend for a year or more.

14 CH4 International Ltd. Format as revised 1989. This is an example of a sampling programme report; core samples are preferred over chips, and the report format is similar.

15 Op cit. supra n.14.

16 Roke Oil Enterprises Ltd. provides these logs. The tools are researched and built by them, and they have for many years operated the only 5 point density logging tool calibration facility. The tools used are specifically designed and properly calibrated for coal. They also offer a coal-water-ash determination programme.

17 Logs from CH4 International Ltd. files.

18 Patents first held by Nova, an Alberta Corporation, have been purchased by A. Kahil/Cantek Consulting.

19 Dr Masszi is President of D. Masszi Consulting Services Ltd.

20 Drill Systems of Calgary manufactures this system.

21 Proudlock, Peter J. Drawing from CH4 International Ltd. files. Calgary, 1985.

NAMES	COMPANY	PHONE
ADAMS, WALTER	BRALSA EXPORATIONS INC.	(403)269-1965
ALGAR, MARK	ECLIPSE ENERGY INC.	(403)246-8715
AUKES PETER	NORCEN ENERGY RESOURCES LTD.	(403)231-0111
BAILEY, ROBERT	NORWEST MINE SERVICES LTD.	(403)237-7763
BAMFORD, TOM	SASKATCHEWAN OIL AND GAS CORPORATION	(306)781-8330
BENEDIKTSON, STEVE	PALOMA PETROLEUM LTD.	(403)265-9265
BOISVERT, DOUG	ALBERTA RESEARCH COUNCIL	(403)438-7638
BOON, JAN	ALBERTA RESEARCH COUNCIL	(403)438-7615
BOSMAN, DANE	CANADIAN HUNTER EXPLORATION LTD.	(403)260-1893
BRITCH, CLIFF	WESTAR MINING LTD.	(604)681-8222
BROOK, JOHN	HOME OIL COMPANY LTD.	(403)232-7420
BROWN, KEN	HOME OIL COMPANY LIMITED	(403)232-7100
BYRNES, TOM	ENERGY RESOURCES CONSERVATION BOARD	(403)297-8553
CANYON, CANDICE	B.C. GEOLOGICAL SURVEY	

CARPENTER, BILL	NORWEST MINE SERVICES LTD.	(403)237-7763
CATHYL-BICKFORD, GWYNETH	BICKFORD CONSULTING LTD.	(403)228-7729
CECH, RUDOLF	SPROULE ASSOCIATES LIMITED	(403)269-7951
CENTURY, JOHN	J.R. CENTURY PETROLEUM CONSULTANTS LTD.	(403)262-2835
CHAO, DENNIS	ALBERTA RESEARCH COUNCIL	(403)438-7624
CHISHOLM, DOUGLAS	WALKING STICK OIL & GAS LTD.	(403)261-8926
COLLINS, GEORGE	VEEZAY GEODATA LTD.	(403)249-1666
CRANSTONE, JOHN	GULF CANADA RESOURCES	(403)233-5239
DAVIS, BILL	CANADIAN HUNTER EXPLORATION LTD.	(403)260-1893
DAWSON, MIKE	GEOLOGICAL SURVEY OF CANADA	(403)292-7115
DONNELLY, DOUG	SHELL CANADA LTD.	(403)232-3804
DOWNEY, MIKE	CANADIAN HUNTER EXPLORATION LTD.	(403)260-1000
DRUMMOND, KEN	MOBIL OIL CANADA	(403)260-7910
DUFORD, VIRGINIA		
DUNCAN, RUSS	PARAMOUNT RESOURCES LTD.	(403)266-2047

DUTHIE, BOB	PAN CANADIAN PETROLEUM LTD.	(403)290-2721
FIETZ, DALE	ELAD ENTERPRISES	(403)274-5972
FINN, MICHEAL	HUSKY OIL LTD.	(403)298-6977
FINVERS, MAIJA	ALBERTA ENERGY	(403)427-7749
FITZGERALD, MAUREEN	ALBERTA RESEARCH COUNCIL	(403)438-7617
FLAATEN, NORLEE	PAN CANADIAN PETROLEUM LTD.	(403)290-2000
FRANK, GEORGE	RIF RESOURCES	(403)221-0800
GAREAU, JOHN	PENTAGON ENERGY CORP.	(403)269-6129
GOULET, DIANNE	ALBERTA RESEARCH COUNCIL	(403)450-5481
GRAVES, STAN		(205)969-0423
GRISDALE, JOHN	CANADIAN FRACMASTER LTD.	(403)262-2222
HAGE, TED	NATIONAL ENERGY BOARD	(403)247-4233
HALLETT, ROBERT	REMINGTON ENERGY LTD.	(403)269-9309
HANNA, MOE	HOME OIL COMPANY LIMITED	(403)232-7100
HANNAH, TED	CROWSNEST RESOURCES	(403)232-2157

HARSH, MILTON	PORTER, WHITE, AND YARDLEY	(205)252-3681
HEBIL, KEITH	LUSCAR LTD.	(403)420-5810
HEFFERNAN, KEVIN	NORWEST MINE SERVICES LTD.	(403)237-7763
HEISLER, ROBERT	SUNCOR INC.	(403)269-8100
HOLLINGSHEAD, BARRY	COAL MINING RESEARCH COMPANY	(403)987-8181
HORACHEK, YARO	GEOL-ING RESOURCE CONSULTING LTD.	(403)239-5358
HOWARD, RONALD	HARBOUR PETREOLEUM CO. LTD.	(403)263-5522
HUME, DAVID	REMINGTON ENERGY LTD.	(403)269-9309
ING, ANN	ALBERTA ENERGY	(403)427-7749
INKSTER, RICHARD	GULF CANADA RESOURCES	(403)233-5239
JACOBUS, DAVID	NORTH CANADIAN OILS LTD.	(403)261-3276
JOHNSON, PAUL	NORCEN ENERGY RESOURCES LTD.	(403)231-0111
JORDON, JEFF	NORWEST MINE SERVICES LTD.	(403)237-7763
KAHIL, A.A.	CANTECK CONSULTING	(403)266-0900
KALKREUTH, WOLFGANG	GEOLOGICAL SURVEY OF CANADA	(403)292-7115

KATHOL, DOUG	NORWEST MINE SERVICES LTD.	(403)237-7763
KEITH, DON	ALBERTA RESEARCH COUNCIL	(403)438-7649
KINTON, DAVID	PETRO-CANADA LTD.	(403)296-4666
KIRSCH, DIETER	NORTH CANADIAN OILS LTD.	(403)261-3276
KNOWLES, GREG	NOVA CORP OF ALBERTA	(403)290-7216
LANGENBERG, WILLEM	ALBERTA RESEARCH COUNCIL	(403)438-7620
LANGLO, CYNTHIA	ENERGY RESOURCES CONSERVATION BOARD	(403)297-8463
LEBBERT, RON	SHELL CANADA LTD	(403)232-4018
LEDA, ANGELLO	GULF RESOURCES CANADA	(403)233-5239
LEONHARDT, BOB	PAN CANADIAN PETROLEUM LTD,	(403)290-2702
LOHUIS, GARY	CANADIAN FRACMASTER LTD.	(403)262-2222
LOVESETH, GEORGE	VALLI RESOURCES	
LUFF, DAVE	ALBERTA ENERGY	(403)427-7749
MACDONALD, DON	ALBERTA RESEARCH COUNCIL	(403)427-8042
MACDONALD, MURRAY	WEST COAST PETROLEUM	(403)260-4705

MACGILLIVRAY, JOE	ALBERTA RESEARCH COUNCIL	(403)438-7645
MACKAY, STEVE	CANADIAN HUNTER EXPLORATION LTD.	(403)260-1893
MAHER, JOHN	POLARIS PETROLEUMS LTD.	(403)233-9317
MALOWANY, PETER	NORCEN ENERGY RESOURCES LIMITED	(403)231-0111
MANDRYK, GREG	ALBERTA RESEARCH COUNCIL	(403)438-7641
MANKO, ERNIE	HUSKY OIL LTD.	(403)298-6977
MARCINEW, RICHARD	DOWELL SCHLUMBERGER CANADA	(403)267-3413
MARTONHEGYI, FRANK	B.P. PETROLEUM	(403)237-1617
MASSZI, DENES	CANTECH CONSULTING LTD.	(403)259-4112
MCKENNY, COLLIN	FORDING COAL LTD.	(403)264-1063
MCKENZIE, SCOTT	GULF CANADA RESOURCES	(403)233-5239
MCSADZEAN, BRUCE	POLARIS PETROLEUMS LTD.	(403)233-9317
MCWILLIAMS, GLEN	NORCEN ENERGY RESOURCES LTD.	(403)231-0111
MITCHELL, ART	NORCEN ENERGY RESOURCES LIMITED	(403)231-0410
MONACHELLO, DAVE	PARAMOUNT RESOURCES LTD.	(403)266-2047



MURRAY, KEITH	D. KEITH MURRAY AND ASSOCIATED, INC.	(303)237-3020
NADURAK, JOHN	PALOMA PETROLEUM LTD.	(403)265-9265
NIKOLS, DENNIS	ALBERTA RESEARCH COUNCIL	(403)438-7622
OCKERT, GREG	ESSO RESOURCES CANADA LTD	(403)237-3737
OPEKAR, CHRIS	NORCEN ENERGY RESOURCES LTD.	(403)231-0111
PAGE, GARNET	ALBERTA ENERGY	(403)427-3490
PARK, ROBERT	CANADIAN COMTRA INC.	(403)262-6700
PARKER, DON	MARK RESOURCES INC.	(403)267-1500
PEMBERTON, LARRY	AMOCO CANADA PETROLEUM COMPANY LTD.	(403)233-1200
PFEIFER, TY	WALKING STICK OIL & GAS LTD.	(403)261-8926
PINCKNEY, GEORGE	MOBIL OIL CANADA	(403)260-4382
PORTER, ANDREW	KERR MCGEE CANADA LTD.	(403)263-8840
POTTER, JUDY	J.T. PETROGRAPHICS	(403)260-1935
POTTER, NORM	GULF CANADA RESOURCES	(403)233-5239
PRENTICE, MIKE	ALBERTA RESEARCH COUNCIL	(403)438-7637

PRICHARD, KEN	B.P. PETROLEUM	(403)237-1617
PRIOR, JIM	COMPUTALOG LTD.	(403)298-5707
PROUDLOCK, PETER	CH4 INTERNATIONAL LTD.	
RAHNE, GREG	CONWEST EXPLORATION COMPANY LTD.	(403)233-2424
RAILTON, JOHN	COAL ASSOCIATION OF CANADA	(403)262-1544
RICHARDSON, RICK	ALBERTA RESEARCH COUNCIL	(403)438-7623
ROBB, GREG	ALBERTA ENERGY COMPANY LTD.	(403)266-8129
ROSS, TOM	ALBERTA ENERGY	(403)427-7749
ROTTENFUSSER, BRIAN	ALBERTA RESEARCH COUNCIL	(403)438-7642
SAWFORD, E.C. (DR.)	SHELL CANADA LTD.	(403)232-3804
SCRIBBINS, BRIAN	MOBIL OIL CANADA	(403)260-7402
SELLENS, ANN	CANADIAN HUNTER EXPLORATION LTD.	(403)260-1893
SIEMENS, CRAIG	ALBERTA ENERGY	(403)427-7749
SMITH, GERARD	MOBIL OIL CANADA	(403)260-2879
SMITH, LES	LAS ENERGY ASSOCIATES LTD.	(403)237-5914

STEVENSON, DERRIL	VIKOR RESOURCES	(403)260-9400
STOKES, ANDREW (DR.)	ENERGY, MINES AND RESOURCES	(403)987-8216
STROBL, RUDY	ALBERTA RESEARCH COUNCIL	(403)438-7640
SUPER, DAN	MOBIL OIL CANADA	(403)260-7402
TREASURE, SHAUNA	ALBERTA RESEARCH COUNCIL	(403)438-7679
TRIMBLE, ROGER	NORCEN ENERGY RESOURCES LTD.	(403)231-0111
UNDERSCHULTZ, JIM	ALBERTA RESEARCH COUNCIL	(403)438-7604
VANDAMME, LUC	NORANDA	(514)630-9355
VITTORATOS, STEVEN	ESSO RESOURCES CANADA	(403)237-3895
WALLACE, JOHN	TAURUS EXPLORATION	(205)326-2710
WATTERS, TIM	HOME OIL COMPANY LTD.	(403)232-7589
WILLIAMS, GORDEN	SUMMUS RESOURCE EVALUATIONS LTD.	(403)247-3225
YERYK, GLEN	NORWEST MINE SERVICES LTD.	(403)237-7763

<u>name</u>	<u>phone</u>
GRANT AUCHINCLOSS GASCAN RESOURCES LTD	264 - 8382
JOHN B. AUMAN CORE LABORATORIES	250 - 4000
BOB BACHYNSKI HOME OIL COMPANY LTD	232 - 7483
LLOYD BEHL AMOCO CANADA LTD	233 - 1038
ROLAND A. BENKIS MONENCO CONSULTANTS LTD.	298 - 4195
RICK BERKLEY BPB WIRELINE SERVICES	234 - 9144
RICHARD BOOTH MINISTRY OF ENERGY,MINES & RES.	604 - 423 - 6884
DOUGLAS A. BOYD HALLIBURTON LOGGING SERVICES	269 - 6141
ALLAN CARSWELL ESSO RESOURCES	237 - 4250
JEFF CHAD SIGNALTA RESOURCES LTD	265 - 5091
JOHN T. CLOW CORE LABORATORIES	250 - 4000
DARRELL COTTERILL ALBERTA RESEARCH COUNCIL	438-7664
OWEN CULLINGHAM MONENCO CONSULTANTS LTD.	298 - 4120
ROBERT L. CURR EPIC RESOURCES (B.C.) LTD	604 - 353 - 2209
GARY ELLERBROK CAPE BRETON DEVELOPMENT CORP.	902 - 564 - 2900
BRIAN FLYNN GULF CANADA RESOURCES LTD	233 - 3890
THOMAS P. GALLAGHER PAUMA RESOURCES LTD	266 - 5353
NORM GARNER SUNCOR INC.	
DAN GATTO PANATLAS ENERGY INC	232 - 8566
WAYNE G. GEDDES WESTAR PETROLEUM LTD	269 - 9239
THOMAS GENTZIS ALBERTA RESEARCH COUNCIL	987-8174
TIM J.R. GODFREY TRANS.ALTA UTILITIES CORP	267 - 7631
DIANNE GOULET ALBERTA RESEARCH COUNCIL	450-5481

<u>name</u>	<u>phone</u>
PETER GRAHAM MANALTA COAL LTD	294 - 5364
STAN GRAVES GRACO RESOURCES	(205) 328-6446
DAN GREEN B.C. MINISTRY OF MINES & PET.RES.	
WARD J. GROSS OTIS ENGINEERING CO. LTD.	275 - 1300
THOMAS HARDING BP RESOURCES CANADA LTD	237 - 1145
KEN HAYES CANADIAN COMETRA INC.	262 - 6700
ALAN A. HIGGINS CZAR RESOURCES LTD	265 - 0270
JOHN A. HOWARD SHELL CANADA LTD	232 - 3338
GREG ISONER	
A. A. KAHIL CANTECK CONSULTING LTD.	266-0900
TED KANIK SIGNALTA RESOURCES LTD.	265-5091
DON KEITH ALBERTA RESEARCH COUNCIL	438-7649
WARD KILBY B.C. GEOLOGICAL SURVEY	(604) 356 - 2276
DAVID KO LORING LABORATORIES	274 - 2777
HAROLD J. KOWALCHUK CORE LABORATORIES	250 - 4002
DON KRONSTEDT PETRO - CANADA	296 - 4036
JIM LAUDER ALBERTA DEPARTMENT OF ENERGY	427-7749
JIM LEE COACHWOOD RESOURCES LTD	244 - 1117
HOK LEUNG TRANSCANADA PIPELINES	268 - 6998
GARY W. LITSCHKE GEODATA LTD	265 - 3773
DAVE LONEY ESSO RESOURCES CANADA LTD	237 - 4250
BRIAN LYONS MONENCO CONSULTANTS LTD.	298 - 4647
GORDON MACLEOD HOME OIL COMPANY LTD	232 - 7530

<u>name</u>	<u>phone</u>
J. McCLENNAN HOME OIL COMPANY LTD	232 - 7445
BRIAN MCFARLANE ALBERTA RESEARCH COUNCIL	987-8159
KEITH McLEAN McLEAN OIL AND GAS LTD	266 - 2602
W.R. McLEAY MCLEAY GEOLOGICAL CONSULTANTS.	250 1806
MAGDY W. MIKHAIL CANMET/CRL	987 - 8225
DOUG MILLER TRANSCANADA PIPELINES	268 - 6982
ROBERT J. MORRIS BEACON HILL CONSULTANTS LTD.	604 - 423 - 4531
KEN MURPHY CANADA NORTHWEST ENERGY LTD	260 - 2982
D. KEITH MURRAY D. KEITH MURRAY & ASSOCIATED	(303) 237-3020
DENNIS NIKOLS ALBERTA RESEARCH COUNCIL	438-7622
JOE OLIC ALBERTA RESEARCH OCUNCIL	438-7651
NEIL E. ORR HOME OIL COMPANY LTD	232 - 7602
JIM PRIOR COMPUTALOG LTD	298 - 5707
ERNIE PUCCI ROBBINS AND MYERS INC	236 - 2970
DALE REDEBACK GULF CANADA RESOURCES LTD	233 - 3591
MARCIA REMPE GULF CANADA RESOURCE LTD	233 - 3591
ROGER REYER CORE LABORATORIES	250 - 4000
DAVE RICHARDSON ENERGY, MINES AND PETROLEUM RES.,	604 - 356 - 2750
CLAY RIDDELL PARAMOUNT RESOURCES LTD	266 - 2047
FRED RIDDELL	
SCOTT ROBINSON CHEVRON CANADA RESOURCES LTD	234 - 5026
BRIAN ROTTENFUSSER ALBERTA RESEARCH COUNCIL	438-7642
BRUCE SCOTT WEST COAST ENERGY	(604) 691 - 5118

<u>name</u>	<u>phone</u>
ELVIRA SHIMA E.R.C.B.	297 - 8201
EARLE A. SHIRLEY E.R.C.B.	297 - 8472
MICHEAL SIMPSON HOME OIL COMPANY LTD	232 - 7602
GARTH SLOAN MOBIL OIL	
LES SMITH LAS ENERGY ASSOCIATES LTD.	237-5914
RANDALL D. SMITH HOT ROCK CONSULTANTS LTD	262 - 2633
DARIO SODERO PANATLAS ENERGY INC	232 - 8566
MURRAY SPELRUM	
JOHN G. SPIRO	416 - 822 - 5065
SLAVKO STUHEC ALBERTA RESEARCH COUNCIL	438-7619
LEIGH T. STULL GRIFFIN PUMPS INC.	279 - 4985
LYNN G. TAYLOR WESTAR MINING LTD	604 - 425 - 8147
ALAN R. TOLG CABRE EXPLORATION LTD	265 - 8890
NICK TOPOLYNSKI AMOCO CANADA LTD	233 - 6332
SHAUNA TREASURE ALBERTA RESEARCH COUNCIL	438-7679
FRANK R. TURNER GULF CANADA RESOURCES LTD	233 - 4208
BETTY WAGENSEIL ALBERTA RESEARCH COUNCIL	438-7616
JOHN WALLACE TAURUS EXPLORATION	(205) 326-2710
MIKE WEBER SUNCOR INC.	
ALAN WEBSTER ENERGY, MINES AND RESOURCES	613 - 996 - 6202
GORDON WILLIAMS SUMMUS RESOURCE EVALUATIONS	247-3225
PAUL V. WILSON MANCAL LTD	294 - 5333
BERNIE WYLIE PARAMOUNT RESOURCES LTD	266 - 2047

name

K.C. YEUNG  
SUNCOR

MIKE ZAYAT  
MOBIL OIL CANADA

phone

269 - 8770

260 - 7637



- 1) Robert Balabas.....239-6810  
Alberta Southern Drilling
- 2) Tom Demchuk.....232-7602  
Home Oil Company Ltd. Fax.....232-7578
- 3) Gordon Driedger.....279-4985  
Griffin Pumps Inc. Fax.....236-2296
- 4) Gail Grout.....297-2620  
Alta. Research CouncilFax.....297-3003
- 5) W.R. Jones.....  
McLeay Consultant Fax.....
- 6) Robert Nowak.....226-0330  
Groundwater Exploration & Research Ltd.
- 7) Robert Porteous.....232-6772  
Porteous Engineering Fax.....265-9363
- 8) Roger Shaneman.....294-5077  
Fax.....294-5060  
Manalta Coal Ltd./ Gregg River Resources
- 9) Ken Sinclair.....230-4000  
Geotech Fax.....230-4370
- 10) Ron. H. Venter.....297-8386  
ERCB
- 11) Peter Waite.....233-4000  
Gulf Canada Resources
- 12) Brian Wells.....294-5555  
Pembina Fax.....237-0254